



Industrial Automation Headquarters

Delta Electronics, Inc.
Taoyuan Technology Center
No.18, Xinglong Rd., Taoyuan City,
Taoyuan County 33068, Taiwan
TEL: 886-3-362-6301 / FAX: 886-3-371-6301

Asia

Delta Electronics (Jiangsu) Ltd.
Wujiang Plant 3
1688 Jiangxing East Road,
Wujiang Economic Development Zone
Wujiang City, Jiang Su Province,
People's Republic of China (Post code: 215200)
TEL: 86-512-6340-3008 / FAX: 86-769-6340-7290

Delta Greentech (China) Co., Ltd.
238 Min-Xia Road, Pudong District,
Shanghai, P.R.C.
Post code : 201209
TEL: 86-21-58635678 / FAX: 86-21-58630003

Delta Electronics (Japan), Inc.
Tokyo Office
2-1-14 Minato-ku Shibadaimon,
Tokyo 105-0012, Japan
TEL: 81-3-5733-1111 / FAX: 81-3-5733-1211

Delta Electronics (Korea), Inc.
1511, Byucksan Digital Valley 6-cha, Gasan-dong,
Geumcheon-gu, Seoul, Korea, 153-704
TEL: 82-2-515-5303 / FAX: 82-2-515-5302

Delta Electronics Int'l (S) Pte Ltd
4 Kaki Bukit Ave 1, #05-05, Singapore 417939
TEL: 65-6747-5155 / FAX: 65-6744-9228

Delta Electronics (India) Pvt. Ltd.
Plot No 43 Sector 35, HSIIDC
Gurgaon, PIN 122001, Haryana, India
TEL : 91-124-4874900 / FAX : 91-124-4874945

Americas

Delta Products Corporation (USA)
Raleigh Office
P.O. Box 12173, 5101 Davis Drive,
Research Triangle Park, NC 27709, U.S.A.
TEL: 1-919-767-3800 / FAX: 1-919-767-8080

Delta Greentech (Brasil) S.A
Sao Paulo Office
Rua Itapeva, 26 - 3º andar Edifício Itapeva One-Bela Vista
01332-000-São Paulo-SP-Brazil
TEL: +55 11 3568-3855 / FAX: +55 11 3568-3865

Europe

Delta Electronics (Netherlands) B.V.
Eindhoven Office
De Witbogt 20, 5652 AG Eindhoven, The Netherlands
TEL: +31 (0)40-8003800 / FAX: +31 (0)40-8003898

Delta Fan and Pump Drive CFP2000 Series User Manual



Delta Fan and Pump Drive CFP2000 Series User Manual



*We reserve the right to change the information in this user manual without prior notice.



PLEASE READ PRIOR TO INSTALLATION FOR SAFETY.



- ☑ AC input power must be disconnected before any wiring to the AC motor drive is made.
- ☑ Even if the power has been turned off, a charge may still remain in the DC-link capacitors with hazardous voltages before the POWER LED is OFF. Please do not touch the internal circuit and components.
- ☑ There are highly sensitive MOS components on the printed circuit boards. These components are especially sensitive to static electricity. Please do not touch these components or the circuit boards before taking anti-static measures. Never reassemble internal components or wiring.
- ☑ Ground the AC motor drive using the ground terminal. The grounding method must comply with the laws of the country where the AC motor drive is to be installed.
- ☑ DO NOT install the AC motor drive in a place subjected to high temperature, direct sunlight and inflammables.



- ☑ Never connect the AC motor drive output terminals U/T1, V/T2 and W/T3 directly to the AC mains circuit power supply.
- ☑ Only qualified persons are allowed to install, wire and maintain the AC motor drives.
- ☑ Even if the 3-phase AC motor is stop, a charge may still remain in the main circuit terminals of the AC motor drive with hazardous voltages.
- ☑ If the AC motor drive is stored in no charge condition for more than 3 months, the ambient temperature should not be higher than 30 °C. Storage longer than one year is not recommended, it could result in the degradation of the electrolytic capacitors.
- ☑ Connect the drive to a 3-phase three-wire or 3-phase four-wire Wye system to comply with UL standards.
- ☑ Since the leakage current of the motor drive is higher than 3.5 mA a.c. or 10 mA d.c., the end users are advised to follow at least one of the procedures below:
 1. Connect the motor drive to the ground by using a copper wire with a sectional area of 10 mm² minimum or an aluminum wire with a sectional are of 16 mm² minimum.
 2. Install an electricity leakage breaker.
- ☑ Pay attention to the following when transporting and installing this package (including wooden crate, wood stave and carton box)
 1. If you need to sterilize, deform the wooden crate or carton box, please do not use steamed smoking sterilization or you will damage the VFD.
 2. Please use other ways to sterilize or deform.
 3. You may use high temperature to sterilize or deform. Leave the packaging materials in an environment of over 56°C for 30 minutes.
 4. It is strictly forbidden to use steamed smoking sterilization. The warranty does not covered VFD damaged by steamed smoking sterilization.



The content of this manual may be revised without prior notice. Please consult our distributors or download the latest version at <http://www.deltaww.com/services/DownloadCenter2.aspx?secID=8&pid=2&tid=0&CID=06&itemID=060101&typeID=1&downloadID=&title=&dataType=&check=0&hl=en-US>

Table of Contents

CHAPTER 1 INTRODUCTION	1-1
1-1 Receiving and Inspection.....	1-1
1-2 Nameplate Information.....	1-1
1-3 Model Name.....	1-2
1-4 Serial Number.....	1-2
1-5 RFI Jumper.....	1-3
1-6 Dimensions.....	1-7
CHAPTER 2 INSTALLATION	2-1
2-1 Minimum Mounting Clearance and Installation.....	2-1
2-2 Minimum mounting clearance.....	2-2
CHAPTER 3 UNPACKING	3-1
3-1 Unpacking.....	3-1
3-2 The Lifting Hook.....	3-13
CHAPTER 4 WIRING	4-1
4-1 Wiring.....	4-1
4-2 System Wiring Diagram.....	4-6
CHAPTER 5 MAIN CIRCUIT TERMINALS	5-1
5-1 Main Circuit Diagram.....	5-1
5-2 Main Circuit Terminals.....	5-5
CHPATER 6 CONTROL TERMINALS	6-1
6-1 Specifications of Control Terminal.....	6-3
6-2 Analog input terminals (AVI1, ACI, AVI2, ACM)	6-5
6-3 Remove the Terminal Block.....	6-7
CHAPTER 7 OPTIONAL ACCESSORIES	7-1
7-1 All Brake Resistors and Brake Units Used in AC Motor Drives.....	7-2
7-2 Non-fuse Circuit Breaker.....	7-4
7-3 Fuse Specification Chart	7-5
7-4 AC/DC Reactor.....	7-6
7-5 Zero Phase Reactor.....	7-11

7-6 EMC Filter.....	7-12
7-7 Panel Mounting.....	7-16
7-8 Fan Kit.....	7-18
7-9 USB/RS-485 Communication Interface IFD6530.....	7-29
CHAPTER 8 OPTION CARDS.....	8-1
8-1 Removed key cover.....	8-2
8-2 Screws Specification for option card terminals.....	8-3
8-3 EMC-D42A.....	8-8
8-4 EMC-D611A.....	8-8
8-5 EMC-R6AA.....	8-8
8-6 EMC-BPS01.....	8-9
8-7 CMC-MOD01.....	8-10
8-8 CMC-PD01.....	8-13
8-9 CMC-DN01.....	8-15
8-10 CMC-EIP01.....	8-18
8-11 EMC-COP01.....	8-22
CHAPTER 9 SPECIFICATION.....	9-1
9-1 Specification.....	9-1
9-2 Environment for Operation, Storage and Transportation.....	9-3
9-3 Derating of ambient temperature and altitude.....	9-4
CHAPTER 10 DIGITAL KEYPAD.....	10-1
10-1 Descriptions of Digital Keypad	10-2
10-2 Function of Digital Keypad KPC-CC02.....	10-5
10-3 TPEditor Installation Instruction	10-30
10-4 Fault Code Description of Digital Keypad KPC-CC02.....	10-38
10-5 Functions which are not supported when using TPEditor with KPC-CC02.....	10-42
CHAPTER 11 SUMMARY OF PARAMETERS	11-1
CHAPTER 12 DESCRIPTION OF PARAMETER SETTINGS	12-1
CHAPTER 13 WARNING CODES	13-1
CHAPTER 14 FAULT CODES AND DESCRIPTIONS	14-1
CHAPTER 15 CANOPEN OVERVIEW	15-1

CHAPTER 16 PLC FUNCTION.....	16-1
CHAPTER 17 SAFETY TORQUE OFF FUNCTION.....	17-1

Chapter 1 Introduction

1-1 Receiving and Inspection

After receiving the AC motor drive, please check for the following:

1. Please inspect the unit after unpacking to assure it was not damaged during shipment. Make sure that the part number printed on the package corresponds with the part number indicated on the nameplate.
2. Make sure that the voltage for the wiring lie within the range as indicated on the nameplate. Please install the AC motor drive according to this manual.
3. Before applying the power, please make sure that all the devices, including power, motor, control board and digital keypad, are connected correctly.
4. When wiring the AC motor drive, please make sure that the wiring of input terminals "R/L1, S/L2, T/L3" and output terminals "U/T1, V/T2, W/T3" are correct to prevent drive damage.
5. When power is applied, select the language and set parameter groups via the digital keypad (KPC-CC02). When executes trial run, please begin with a low speed and then gradually increases the speed until the desired speed is reached.

1-2 Nameplate Information

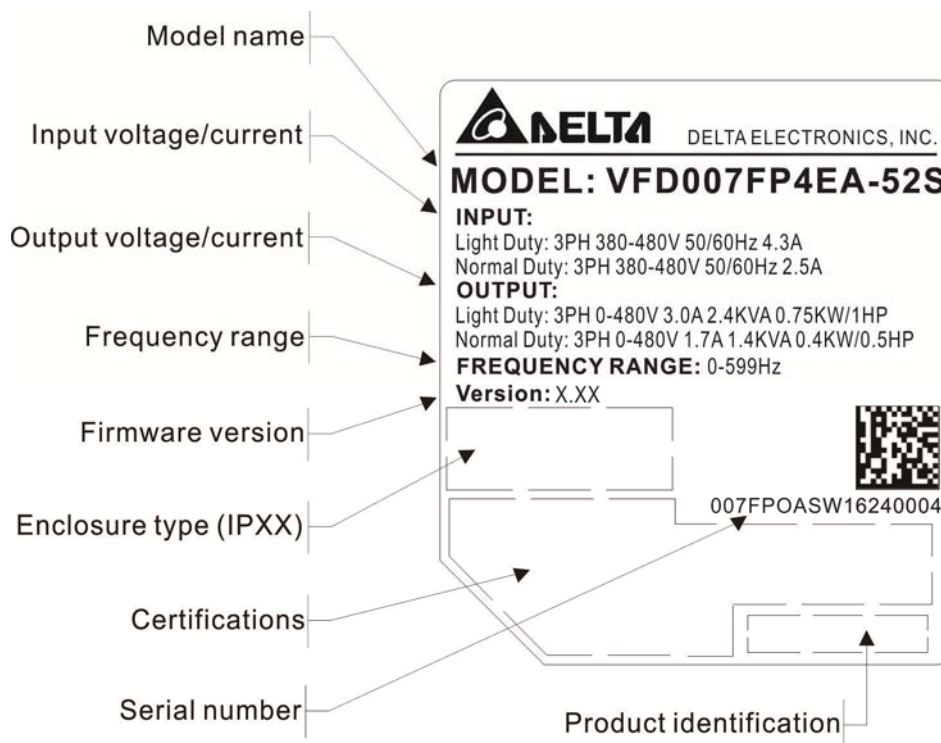

1-3 Model Name

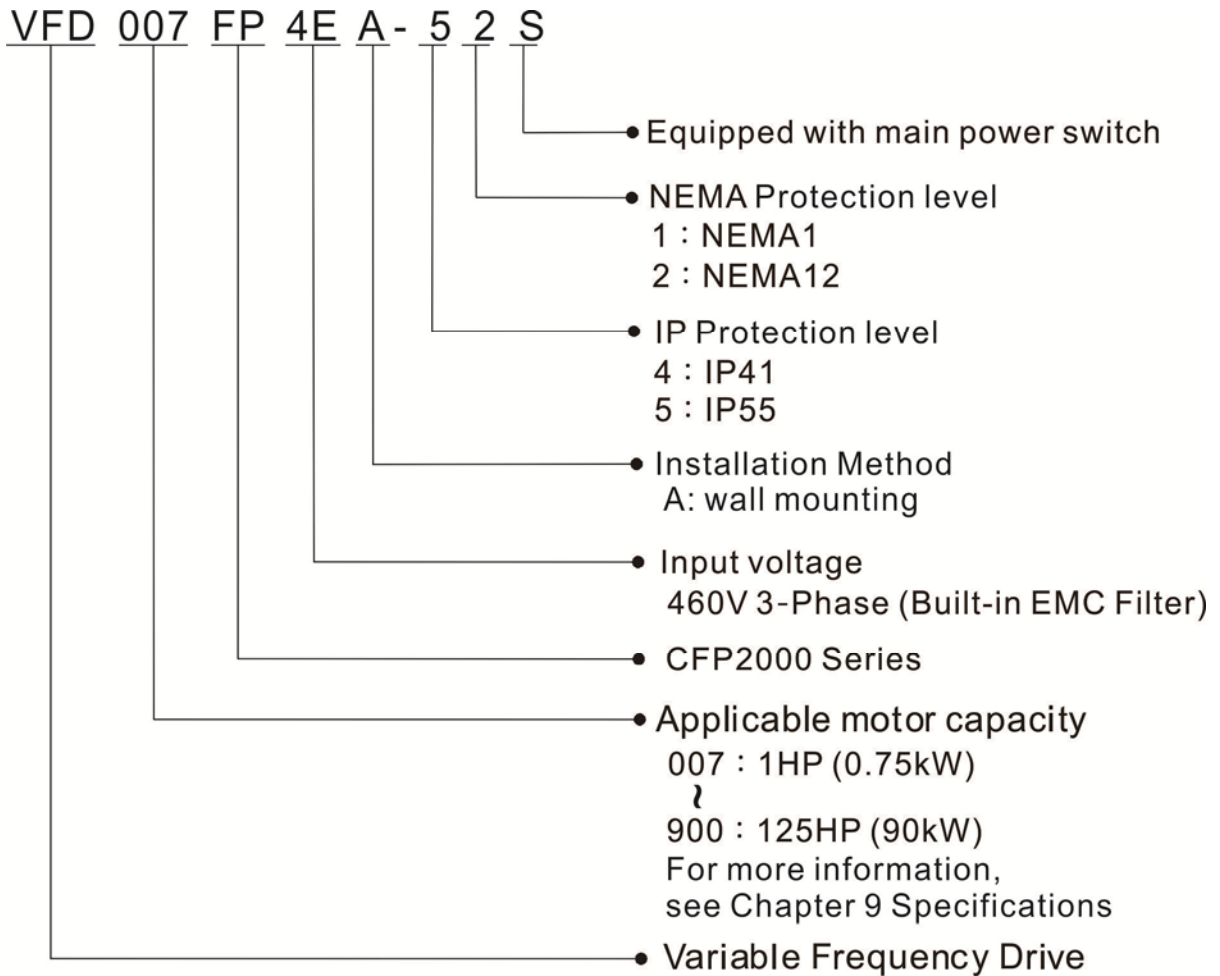

1-4 Serial Number

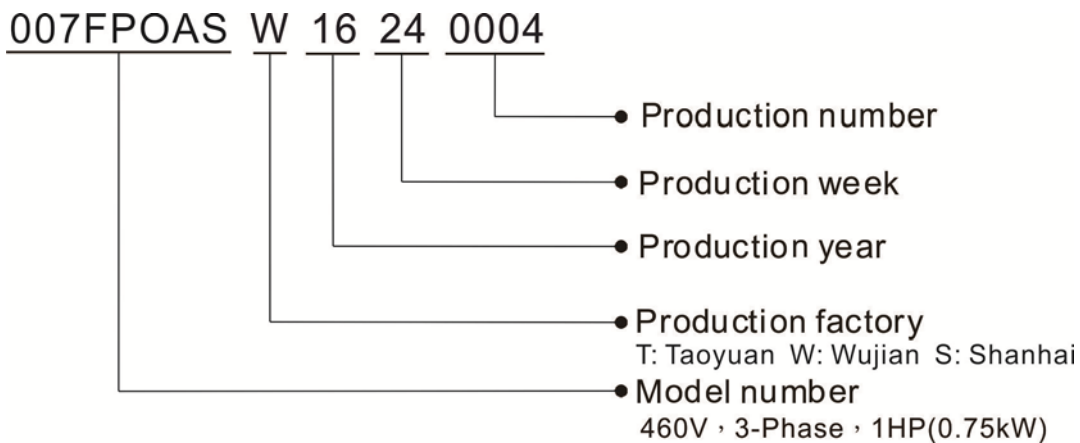

1-5 RFI Jumper

RFI Jumper: The AC motor drive may emit the electrical noise. The RFI jumper is used to suppress the interference (Radio Frequency Interference) on the power line.

Frame A

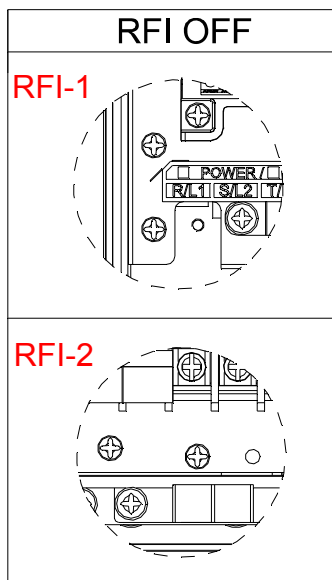
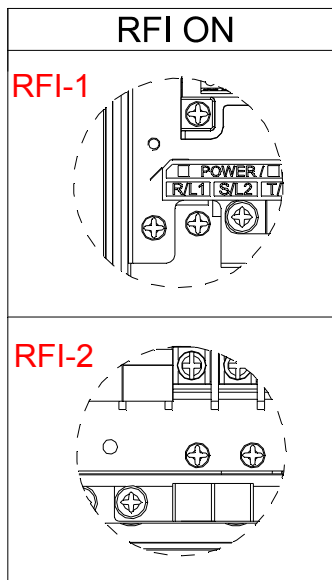
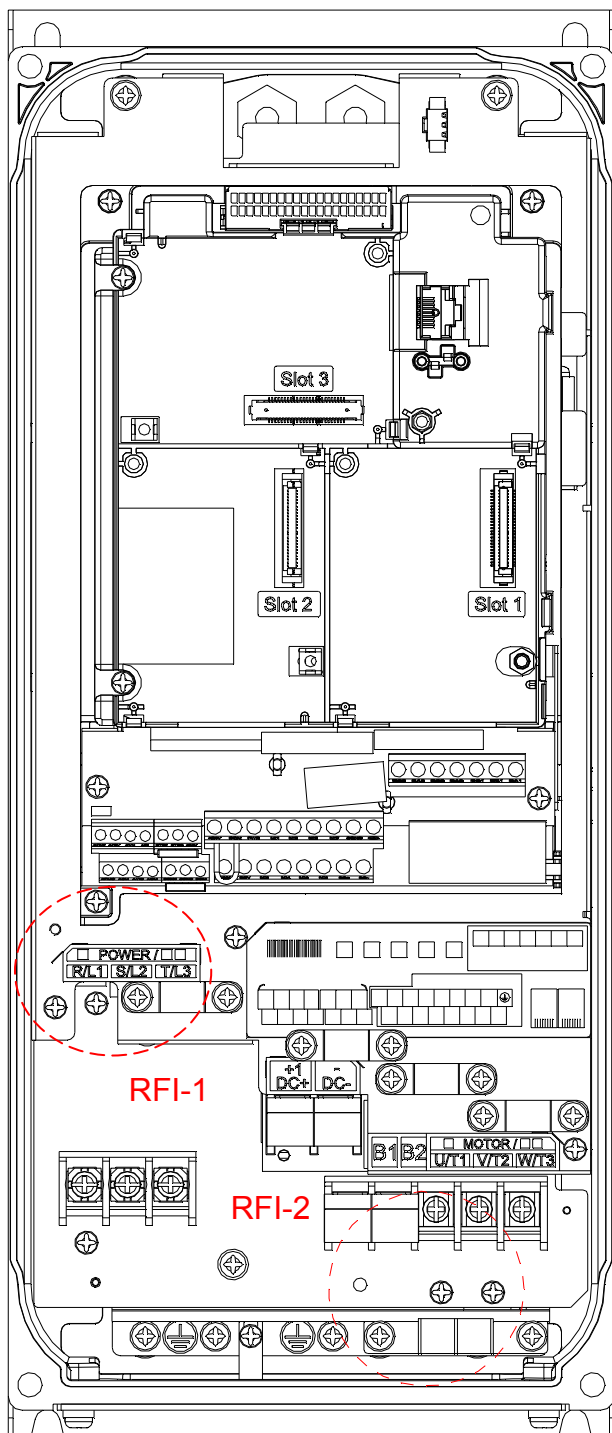

Frame B

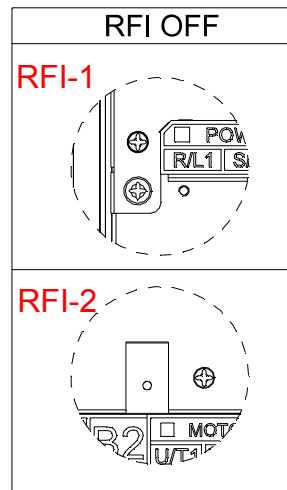
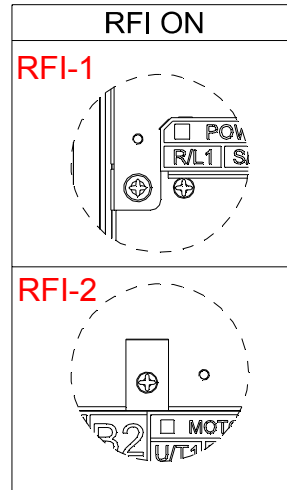
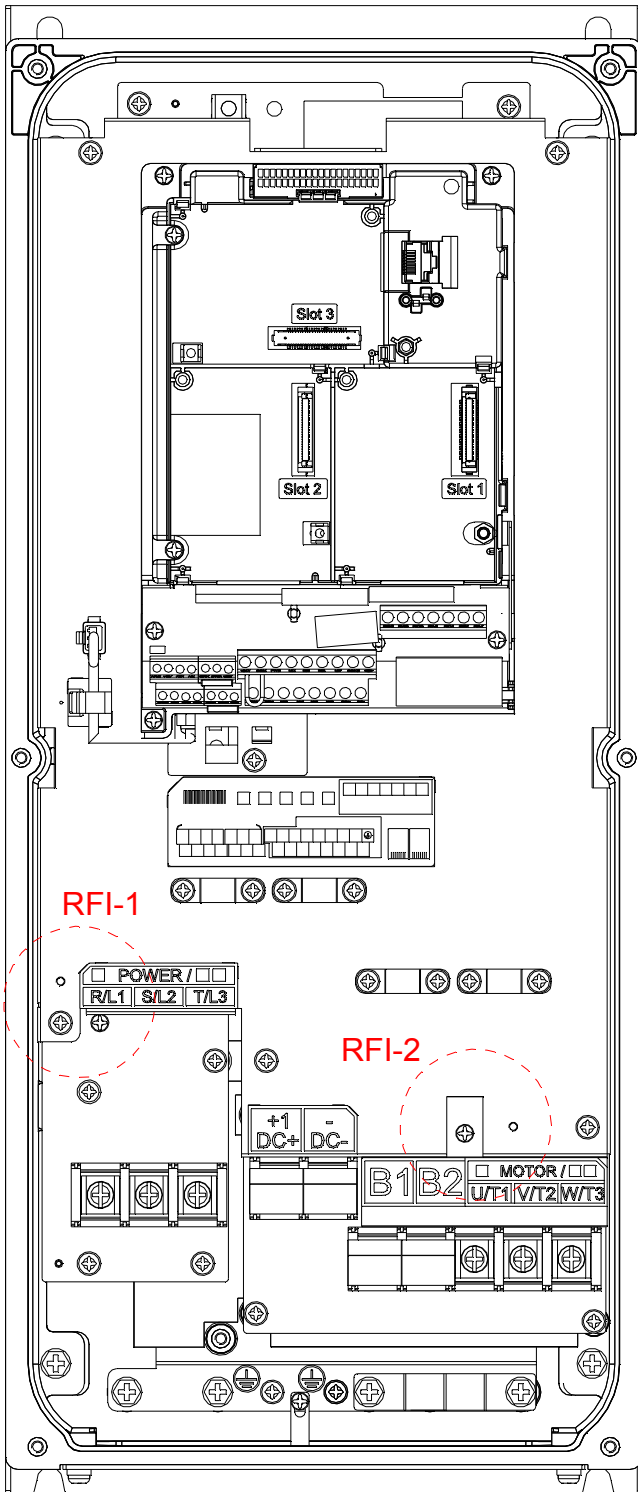

Frame C

By switching the position of the RFI jumper to control On/ Off.

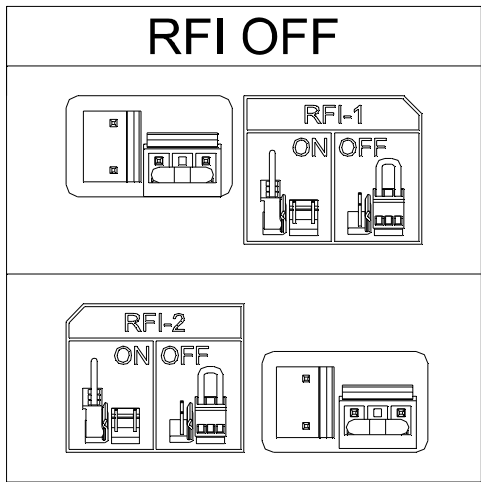
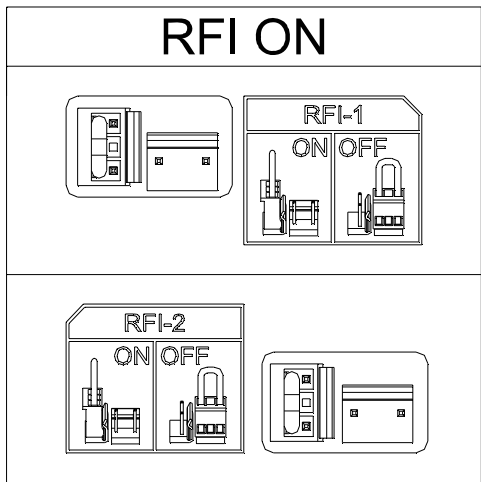
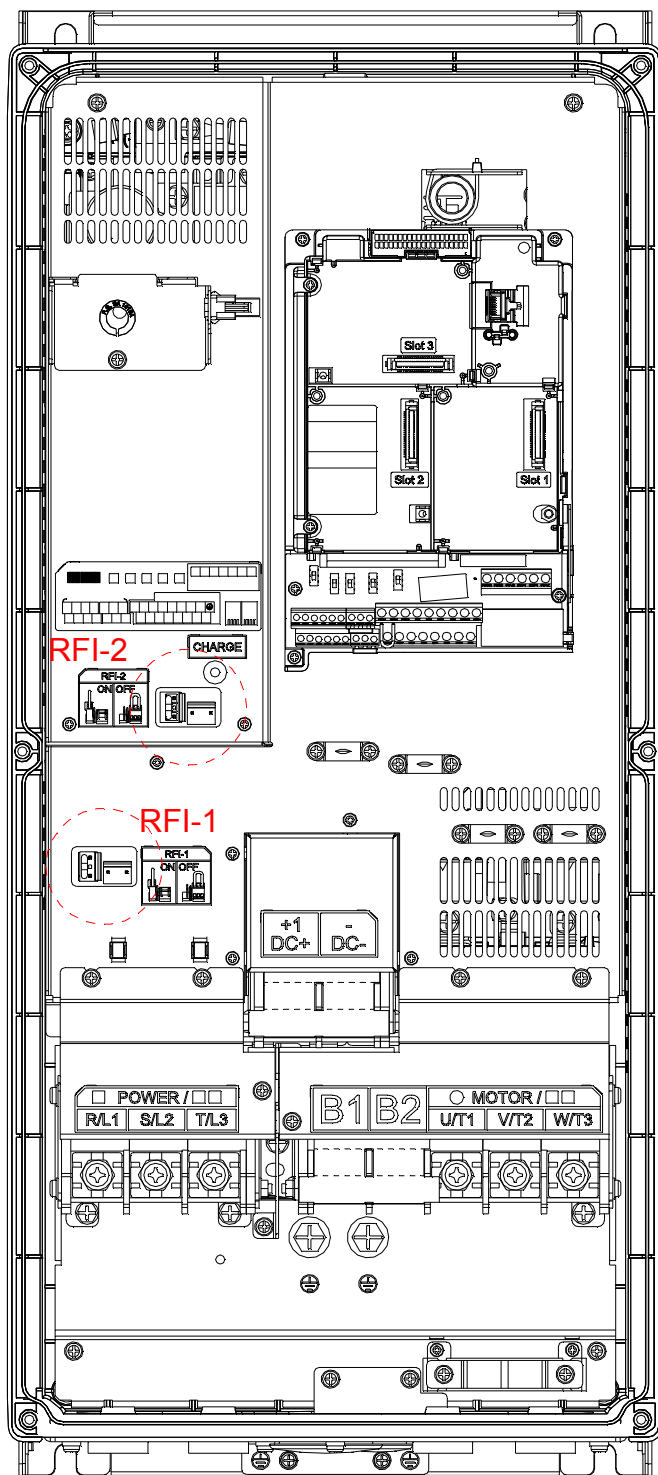

Frame D0

By switching the position of the RFI jumper to control On/ Off.

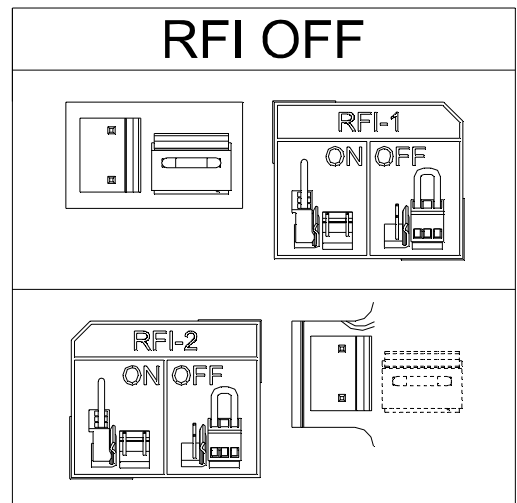
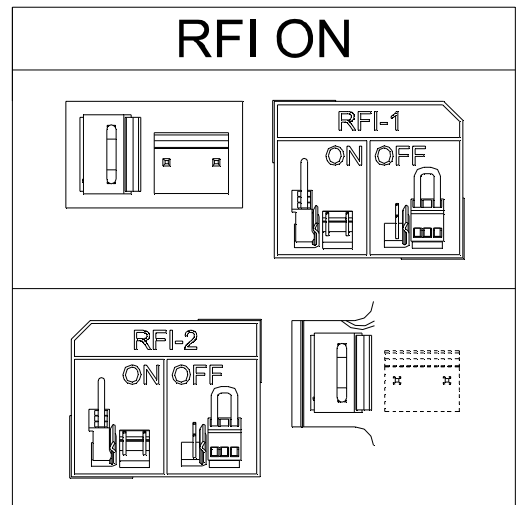
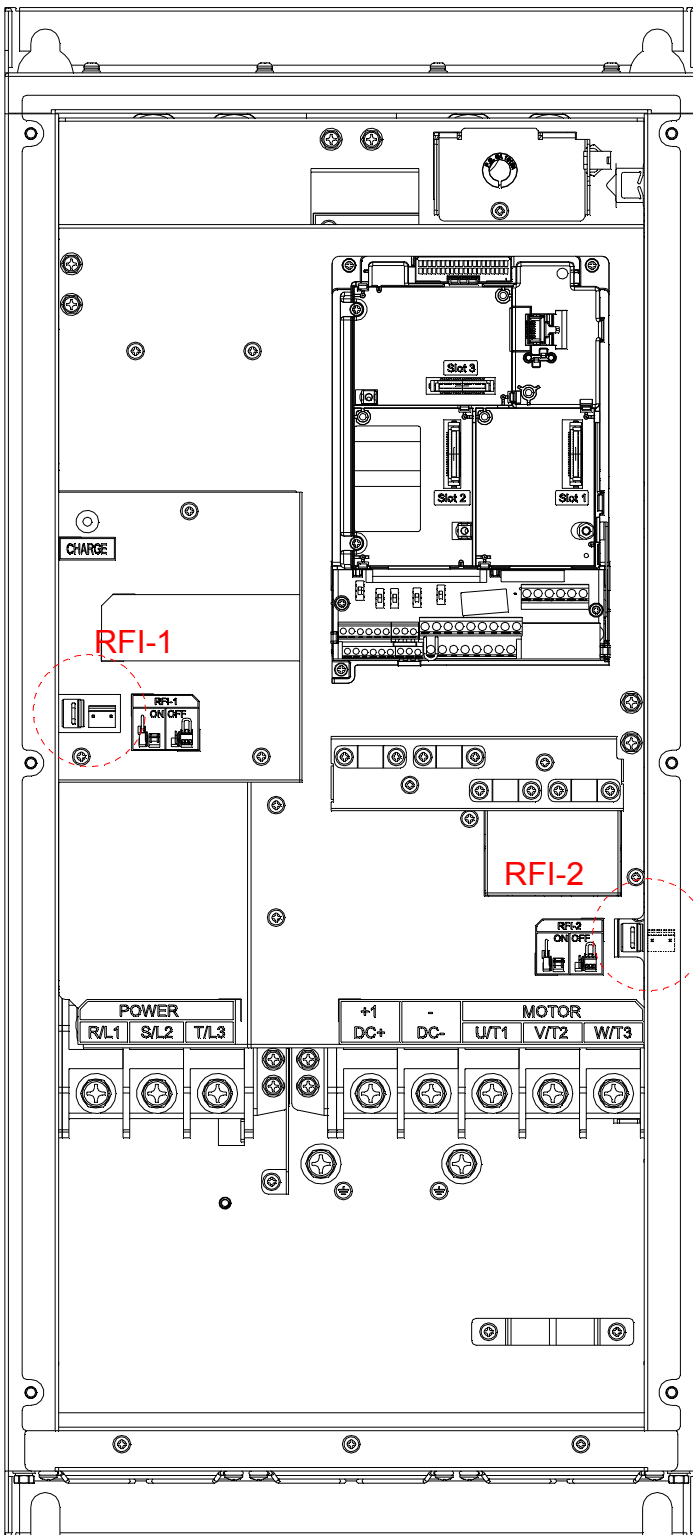

Frame D

By switching the position of the RFI jumper to control On/ Off.

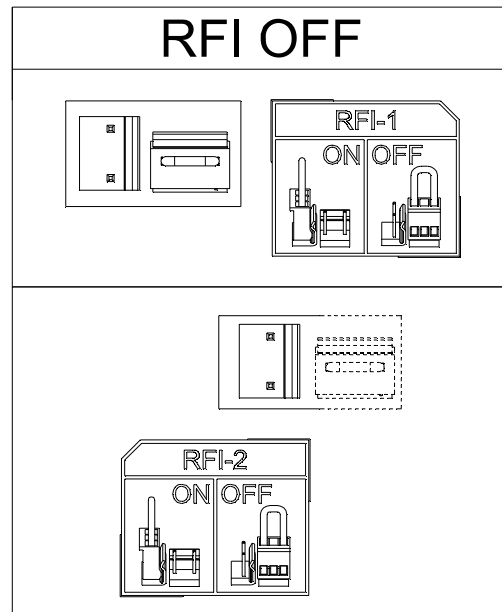
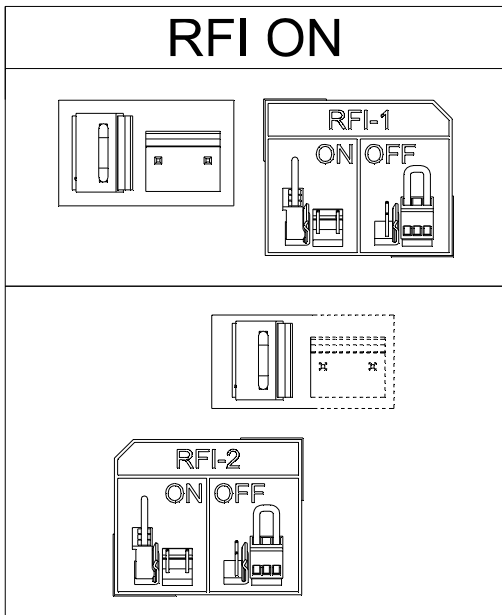
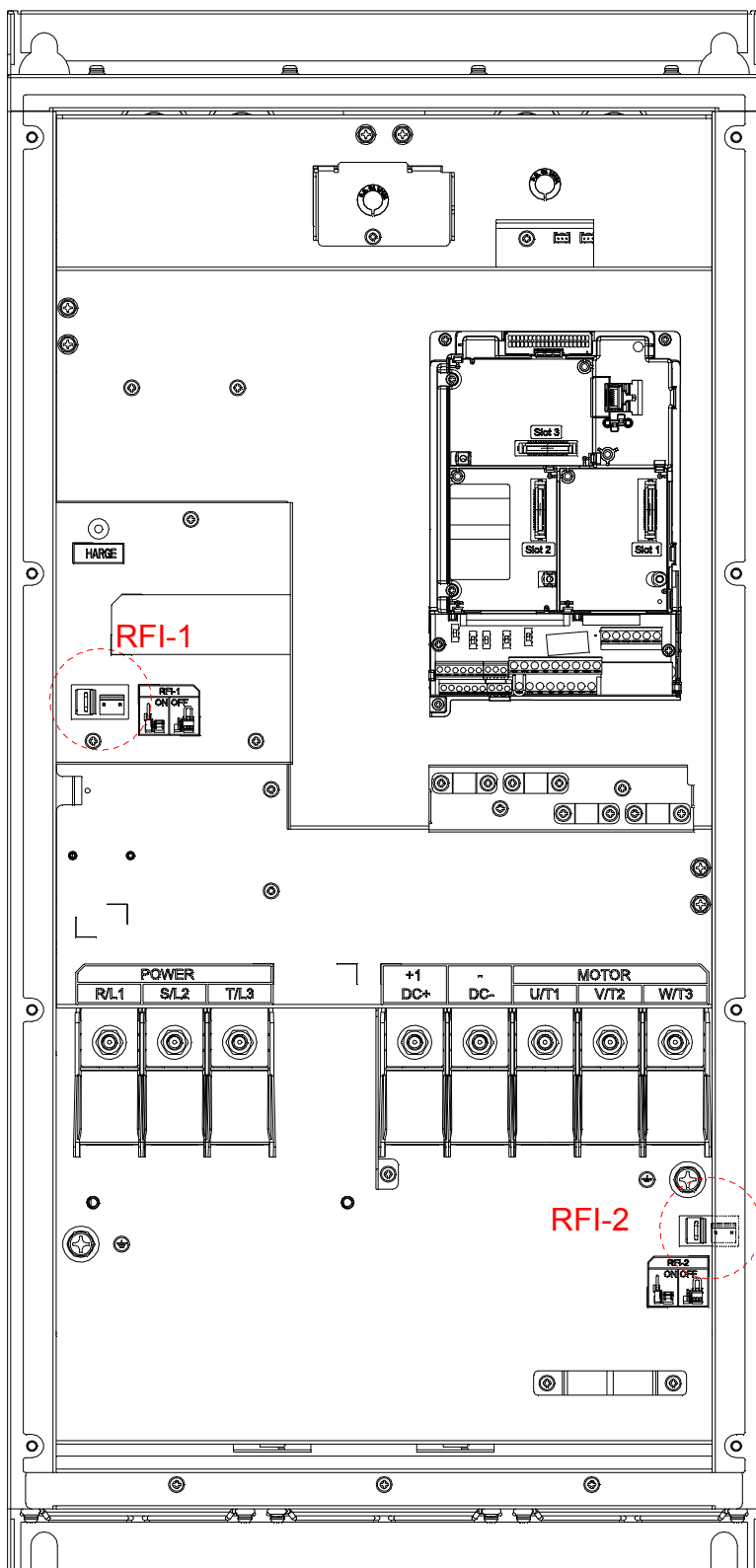

Remove the built-in EMC Filter:

In some specific power system, the shunt capacitors might cause damage on motor drive or electrically charge the enclosure to cause electrical shock. In view of the considerations above, here are the recommendations on jumper/ screw installation of three power systems:

jumper/screw	TN-S System	TT System	IT System
RFI-1	Keep	Keep	Remove
RFI-2	Keep	Remove	Remove

Note 1: If any of the RFI is removed, the EMC effect will be affected.

Note 2: Using a LCB (leakage circuit breaker) designed for motor drive is recommended. If a LCB has tripped, remove the RFI-2 (jumper/ screw) or contact an authorized dealer of Delta near you.

Note 3: Earthing Systems

The international standard IEC60364 distinguishes three different earthing system categories, using the two-letter codes TN, TT, IT.

The **first letter** indicates the type of earthing for the power supply equipment (generator or transformer).

T: One or more points of the power supply equipment are connected directly to the same earthing point.

I: Either no point is connected to earth (isolated) or it is connected to earth via a high impedance.

The **second letter** indicates the connection between earth and the power supply equipment.

T: Connected directly to earth (This earthing point is separate from other earthing points in the power supply system.)

N: Connected to earth via the conductor that is provided by the power supply system

Isolating main power from ground:

When the power distribution system of the Power Regenerative Unit is a floating ground system (IT) or an asymmetric ground system (TN), the RFI short short-circuit cable must be cut off. Cutting off the short-circuit cable cuts off the internal RFI capacitor (filter capacitor) between the system's frame and the central circuits to avoid damaging the central circuits and (according to IEC 61800-3) reduce the ground leakage current.

Important points regarding ground connection

- To ensure the safety of personnel, proper operation, and to reduce electromagnetic radiation, the Power Regenerative Unit must be properly grounded during installation.
- The diameter of the cables must meet the size specified by safety regulations.
- The shielded cable must be connected to the ground of the Power Regenerative Unit to meet safety regulations.
- The shielded cable can only be used as the ground for equipment when the aforementioned points are met.

- ☑ When installing multiple sets of Power Regenerative Units, do not connect the grounds of the Power Regenerative Units in series. As shown below

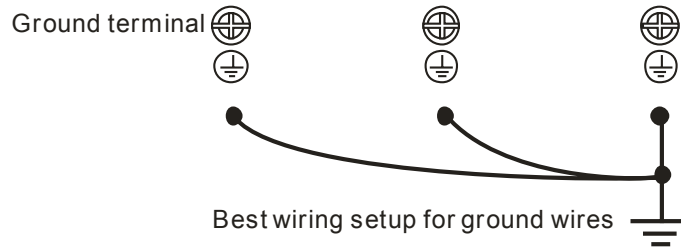

Pay particular attention to the following points:

- ☑ After turning on the main power, do not remove the RFI jumper while the power is on.
- ☑ Make sure the main power is turned off before removing the RFI jumper.
- ☑ Removing the RFI jumper will also cut off the conductivity of the capacitor. Gap discharge may occur once the transient voltage exceeds 1000V.

If the RFI jumper is removed, there will no longer be reliable electrical isolation. In other words, all controlled input and outputs can only be seen as low-voltage terminals with basic electrical isolation. Also, when the internal RFI capacitor is cut off, the Power Regenerative Unit will no longer be electromagnetic compatible.

- ☑ The RFI jumper may not be removed if the main power is a grounded power system.
- ☑ The RFI jumper may not be removed while conducting high voltage tests. When conducting a high voltage test to the entire facility, the main power and the motor must be disconnected if leakage current is too high.

Floating Ground System(IT Systems)

A floating ground system is also called IT system, ungrounded system, or high impedance/resistance (greater than 30Ω) grounding system.

- ☑ Disconnect the ground cable from the internal EMC filter.
- ☑ In situations where EMC is required, check whether there is excess electromagnetic radiation affecting nearby low-voltage circuits. In some situations, the adapter and cable naturally provide enough suppression. If in doubt, install an extra electrostatic shielded cable on the power supply side between the main circuit and the control terminals to increase security.
- ☑ Do not install an external RFI/EMC filter, the EMC filter will pass through a filter capacitor, thus connecting power input to ground. This is very dangerous and can easily damage the Power Regenerative Unit.

Asymmetric Ground System(Corner Grounded TN Systems)

Caution: Do not remove the RFI jumper while the input terminal of the Power Regenerative Unit carries power.

In the following four situations, the RFI jumper must be removed. This is to prevent the system from grounding through the RFI capacitor, damaging the Power Regenerative Unit.

RFI jumper must be removed

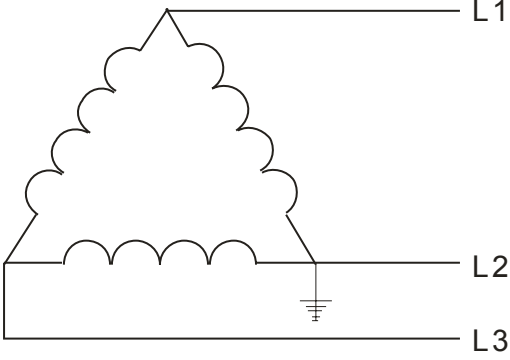
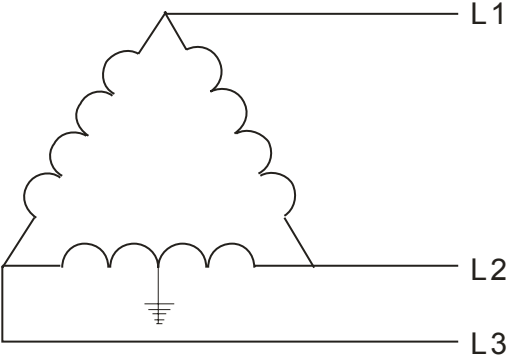
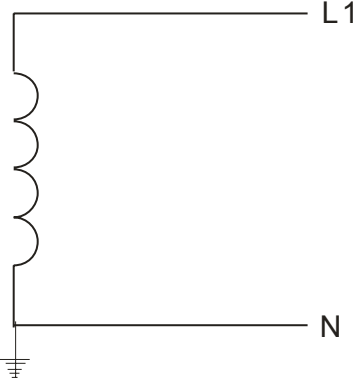
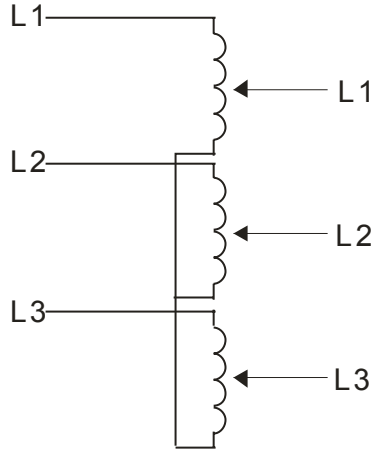
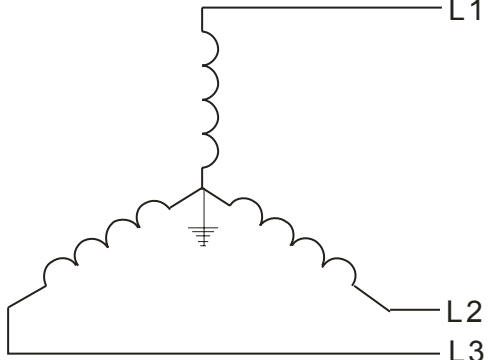
<p>1 Grounding at a corner in a triangle configuration</p> 	<p>2 Grounding at a midpoint in a polygonal configuration</p> 
<p>3 Grounding at one end in a single-phase configuration</p> 	<p>4 No stable neutral grounding in a three-phase autotransformer configuration</p> 
<p>RFI jumper can be used</p>	
<p>Internal grounding through RFI capacitor, which reduces electromagnetic radiation. In a situation with higher requirements for electromagnetic compatibility, and using a symmetrical grounding power system, an EMC filter can be installed. As a reference, the diagram on the right is a symmetrical grounding power system.</p>	

1-6 Dimensions

Frame A

A-1: VFD007FP4EA-52, VFD015FP4EA-52, VFD022FP4EA-52, VFD037FP4EA-52, VFD040FP4EA-52, VFD055FP4EA-52, VFD075FP4EA-52,

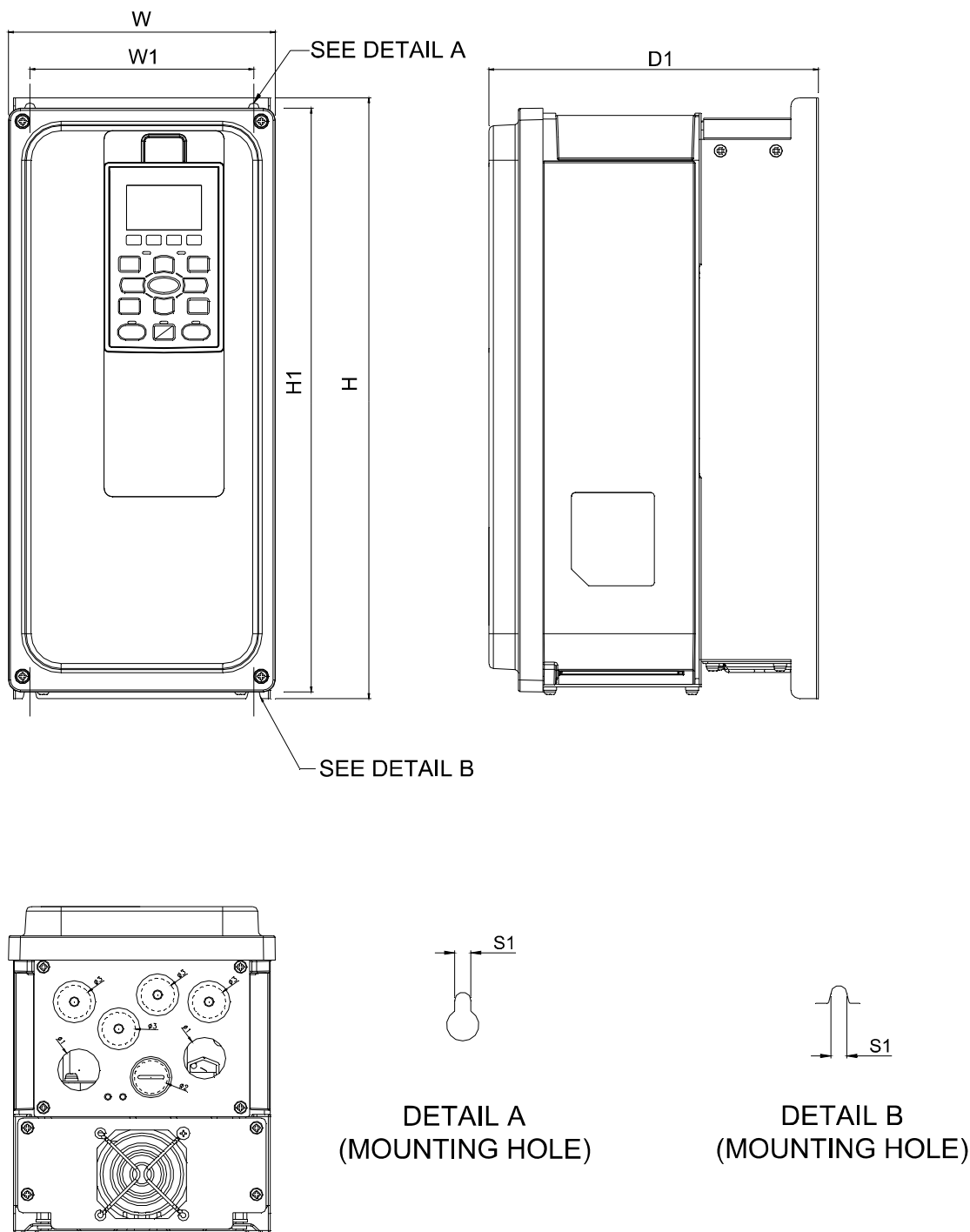

Unit: mm [inch]

Frame	W	W1	H	H1	D	D1	S1	Φ1	Φ2	Φ3
A-1	161.0 [6.34]	135.0 [5.31]	366.4 [14.43]	356.0 [14.02]	-	199.0 [7.83]	6.5 [0.26]	25.4 [1.00]	20.3 [0.80]	20.3 [0.80]

Frame A

A-2: VFD007FP4EA-52S, VFD015FP4EA-52S, VFD022FP4EA-52S, VFD037FP4EA-52S,
 VFD040FP4EA-52S, VFD055FP4EA-52S, VFD075FP4EA-52S

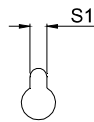
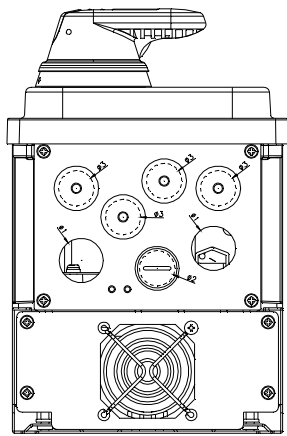
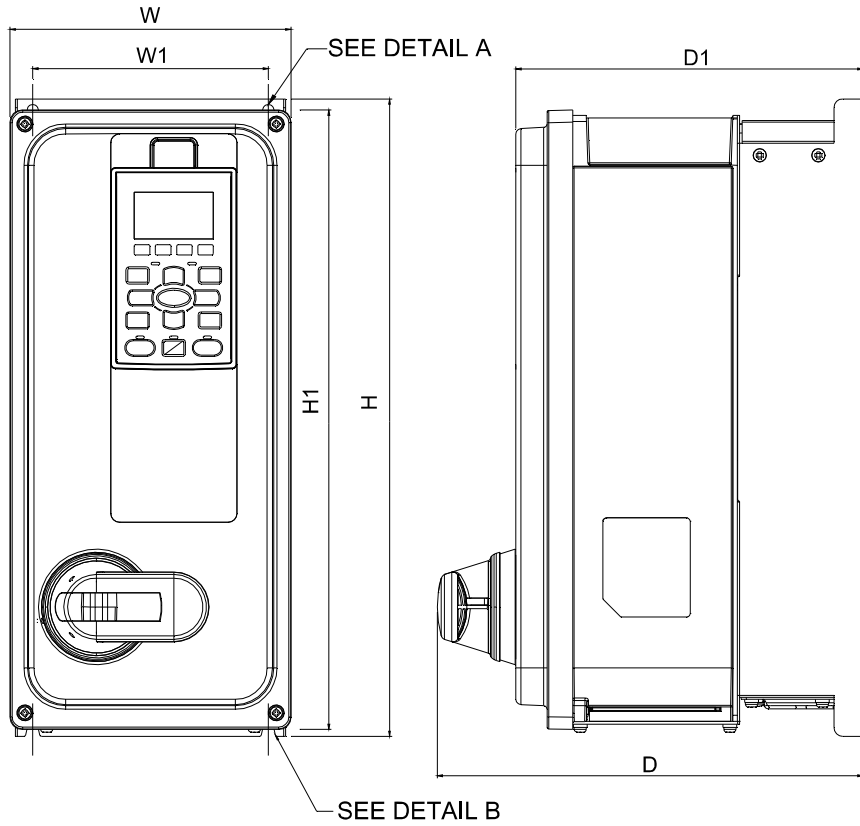

DETAIL A
(MOUNTING HOLE)



DETAIL B
(MOUNTING HOLE)

Unit: mm [inch]

Frame	W	W1	H	H1	D	D1	S1	Φ1	Φ2	Φ3
A-2	161.0 [6.34]	135.0 [5.31]	366.4 [14.43]	356.0 [14.02]	244.0 [9.61]	199.0 [7.83]	6.5 [0.26]	25.4 [1.00]	20.3 [0.80]	20.3 [0.80]

Frame A

A-3: VFD007FP4EA-41, VFD015FP4EA-41, VFD022FP4EA-41, VFD037FP4EA-41, VFD040FP4EA-41, VFD055FP4EA-41, VFD075FP4EA-41

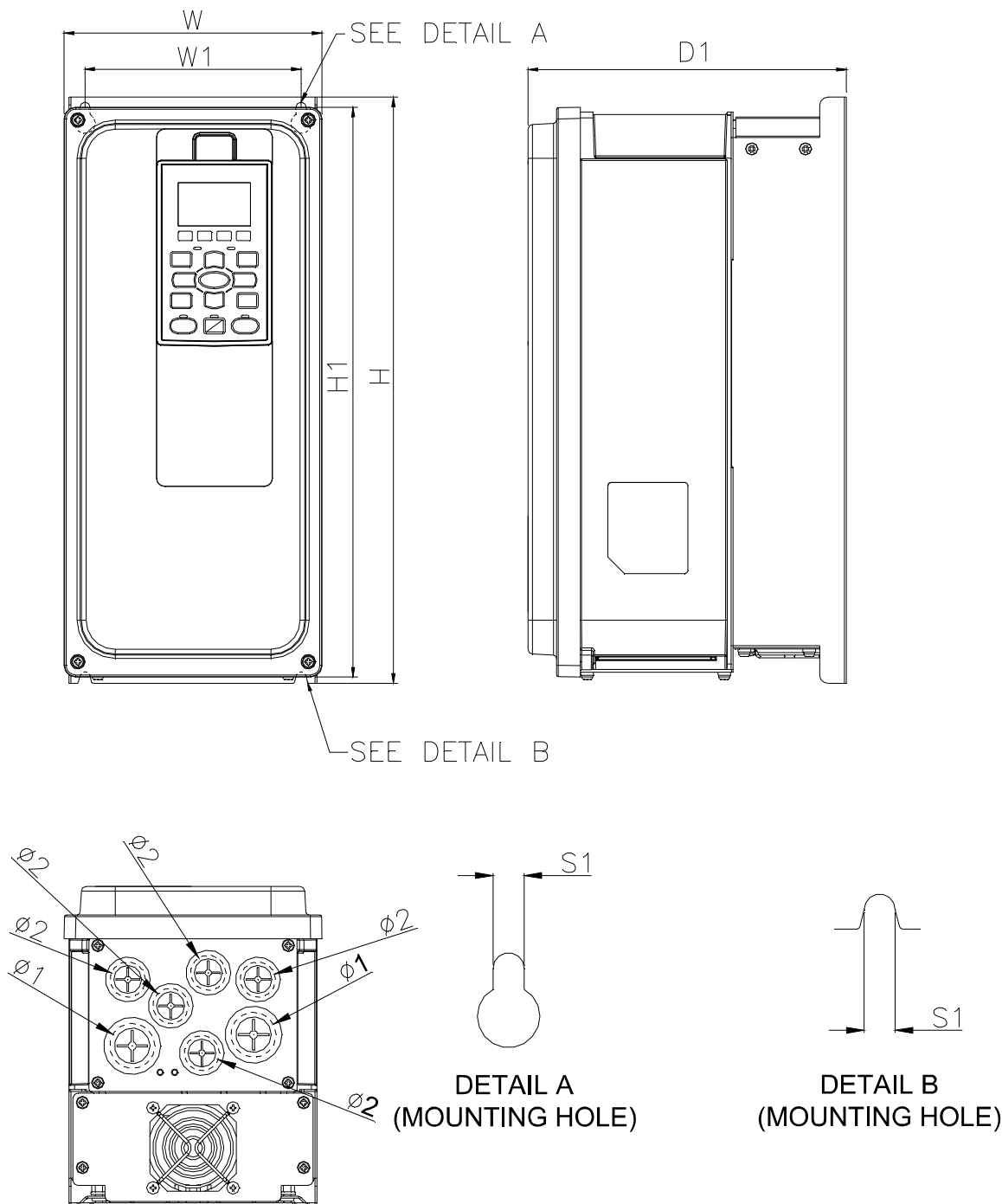

Unit: mm [inch]

Frame	W	W1	H	H1	D	D1	S1	φ1	φ2	φ3
A-3	161.0 [6.34]	135.0 [5.31]	366.4 [14.43]	356.0 [14.02]	-	199.0 [7.83]	6.5 [0.26]	25.4 [1.00]	20.3 [0.80]	-

Frame B

B-1: VFD110FP4EA-52, VFD150FP4EA-52, VFD185FP4EA-52, VFD220FP4EA-52,

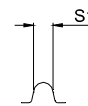
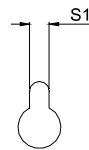
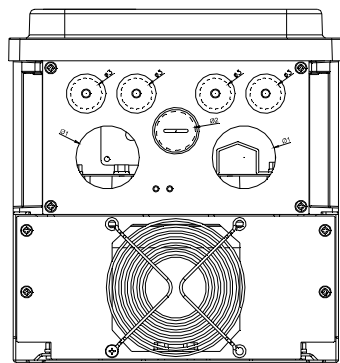
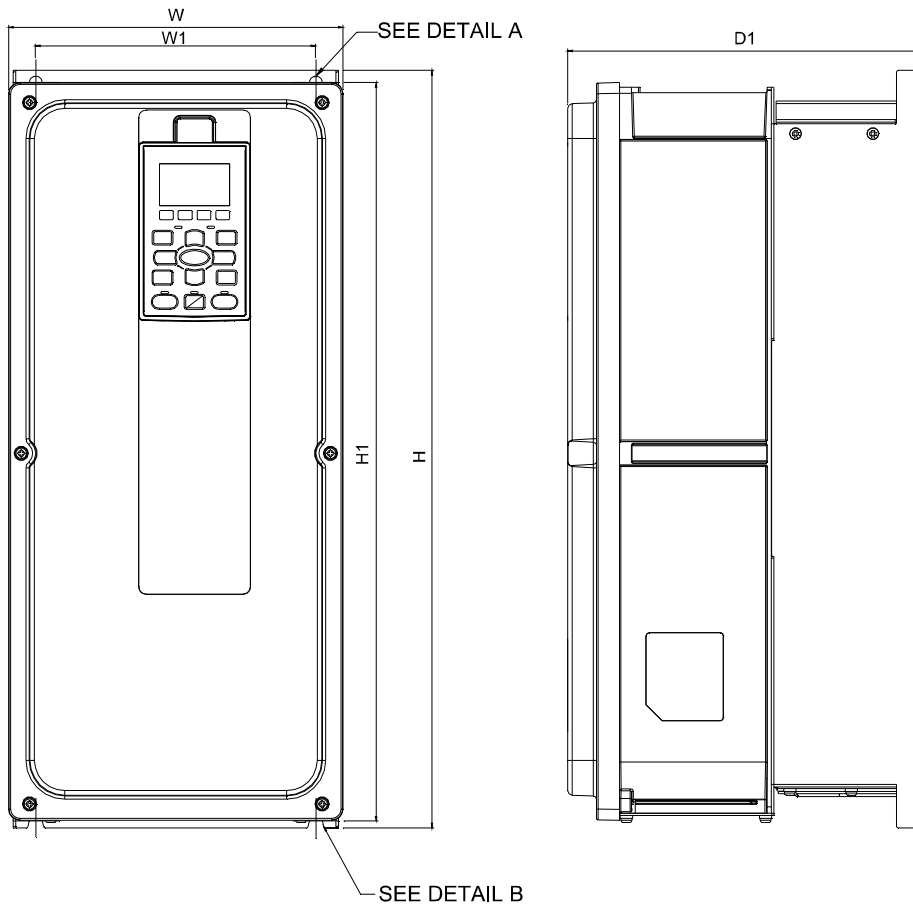

DETAIL A
(MOUNTING HOLE)

DETAIL B
(MOUNTING HOLE)

Unit: mm [inch]

Frame	W	W1	H	H1	D	D1	S1	Φ1	Φ2	Φ3
B-1	261.0 [8.50]	181.0 [7.13]	491.4 [19.35]	479.0 [18.86]	-	229.0 [9.02]	8.5 [0.33]	41.0 [1.61]	25.4 [1.00]	20.3 [0.80]

Frame B

B-2: VFD110FP4EA-52S, VFD150FP4EA-52S, VFD185FP4EA-52S, VFD220FP4EA-52S

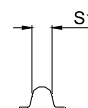
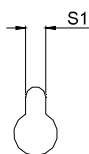
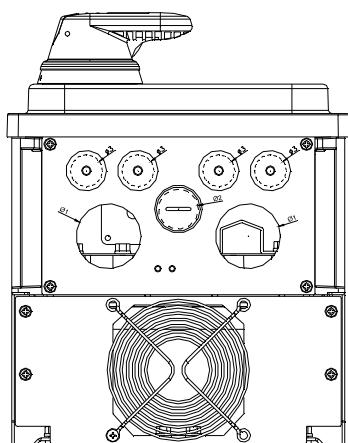
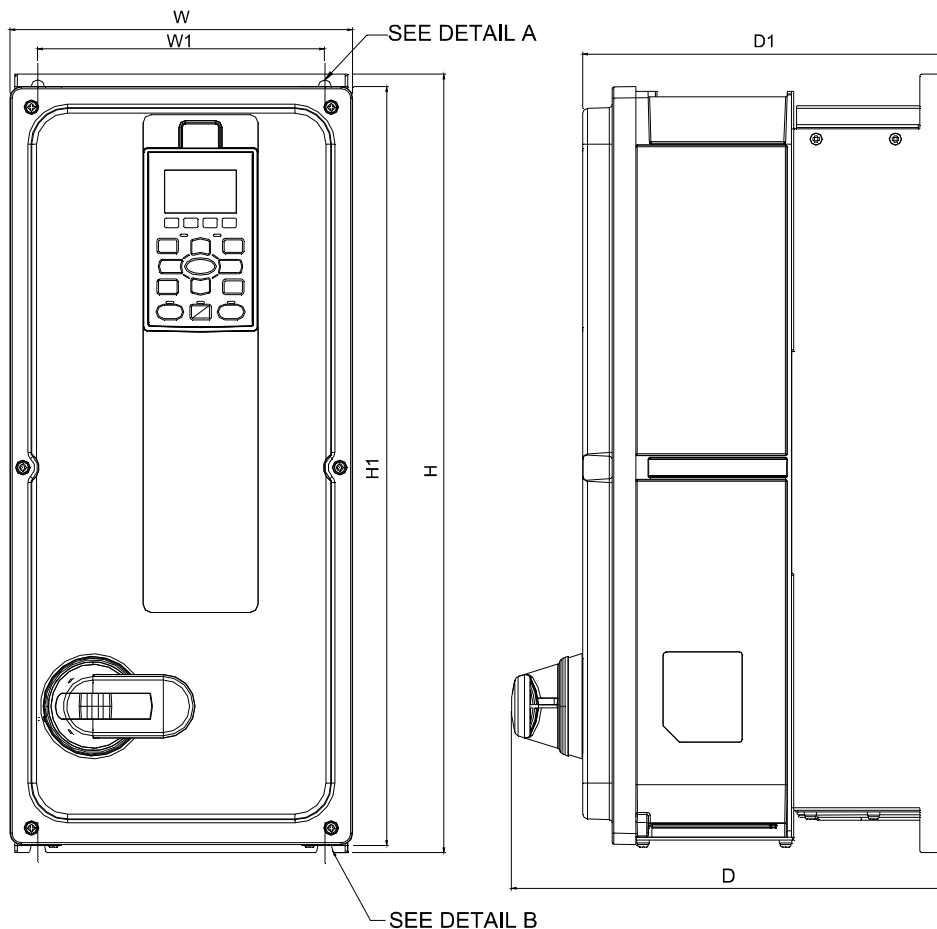

DETAIL A (MOUNTING HOLE)

DETAIL B (MOUNTING HOLE)

Unit: mm [inch]

Frame	W	W1	H	H1	D	D1	S1	Φ1	Φ2	Φ3
B-2	261.0 [8.50]	181.0 [7.13]	491.4 [19.35]	479.0 [18.86]	274.0 [10.79]	229.0 [9.02]	8.5 [0.33]	41.0 [1.61]	25.4 [1.00]	20.3 [0.80]

Frame B

B-3: VFD110FP4EA-41, VFD150FP4EA-41, VFD185FP4EA-41, VFD220FP4EA-41

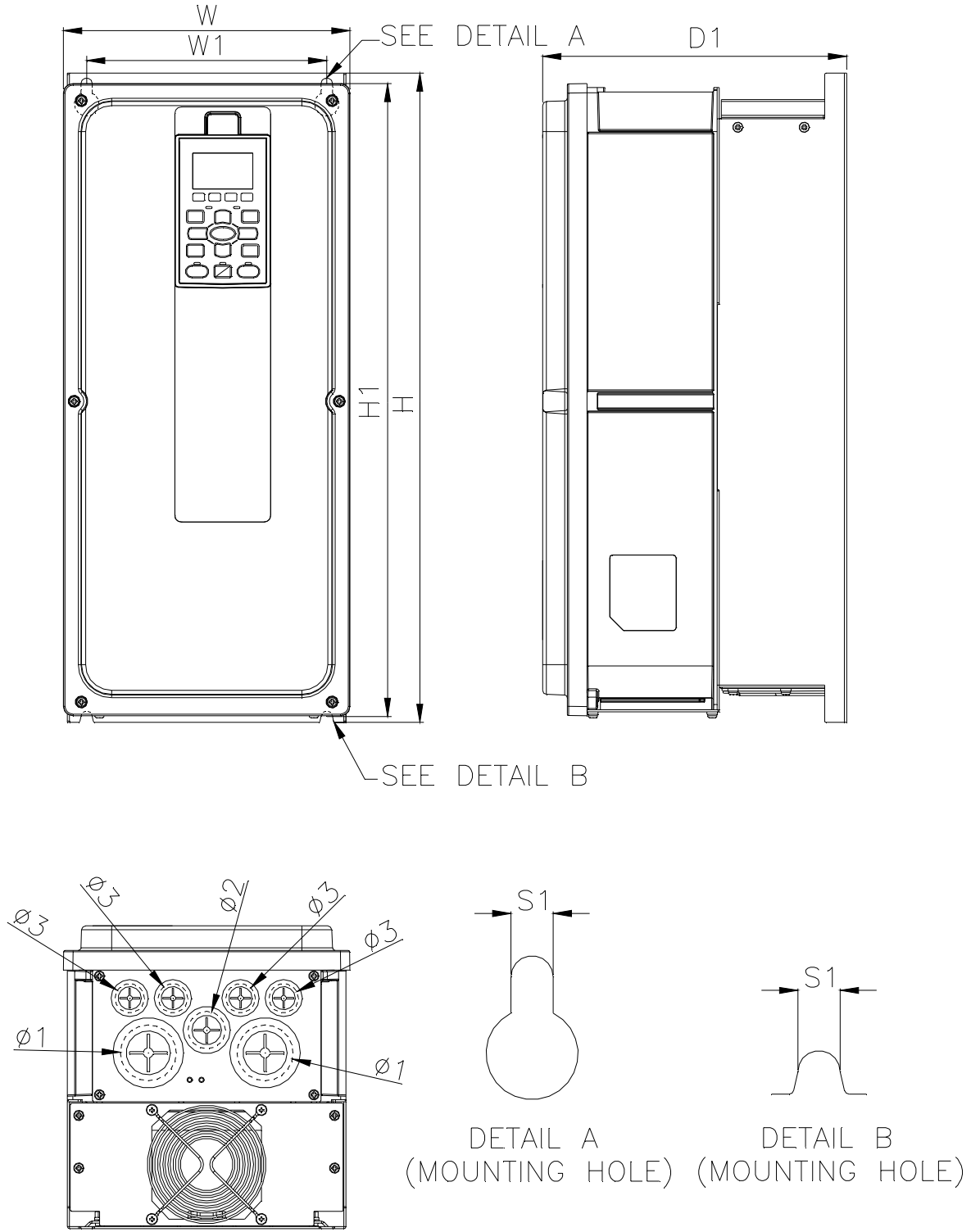

Unit: mm [inch]

Frame	W	W1	H	H1	D	D1	S1	$\phi1$	$\phi2$	$\phi3$
B-3	216.0 [8.50]	181.0 [7.13]	491.4 [19.35]	479.0 [18.86]	-	229.0 [9.02]	8.5 [0.33]	41.8 [1.65]	28.0 [1.10]	22.0 [0.87]

Frame C

C-1: VFD300FP4EA-52, VFD370FP4EA-52

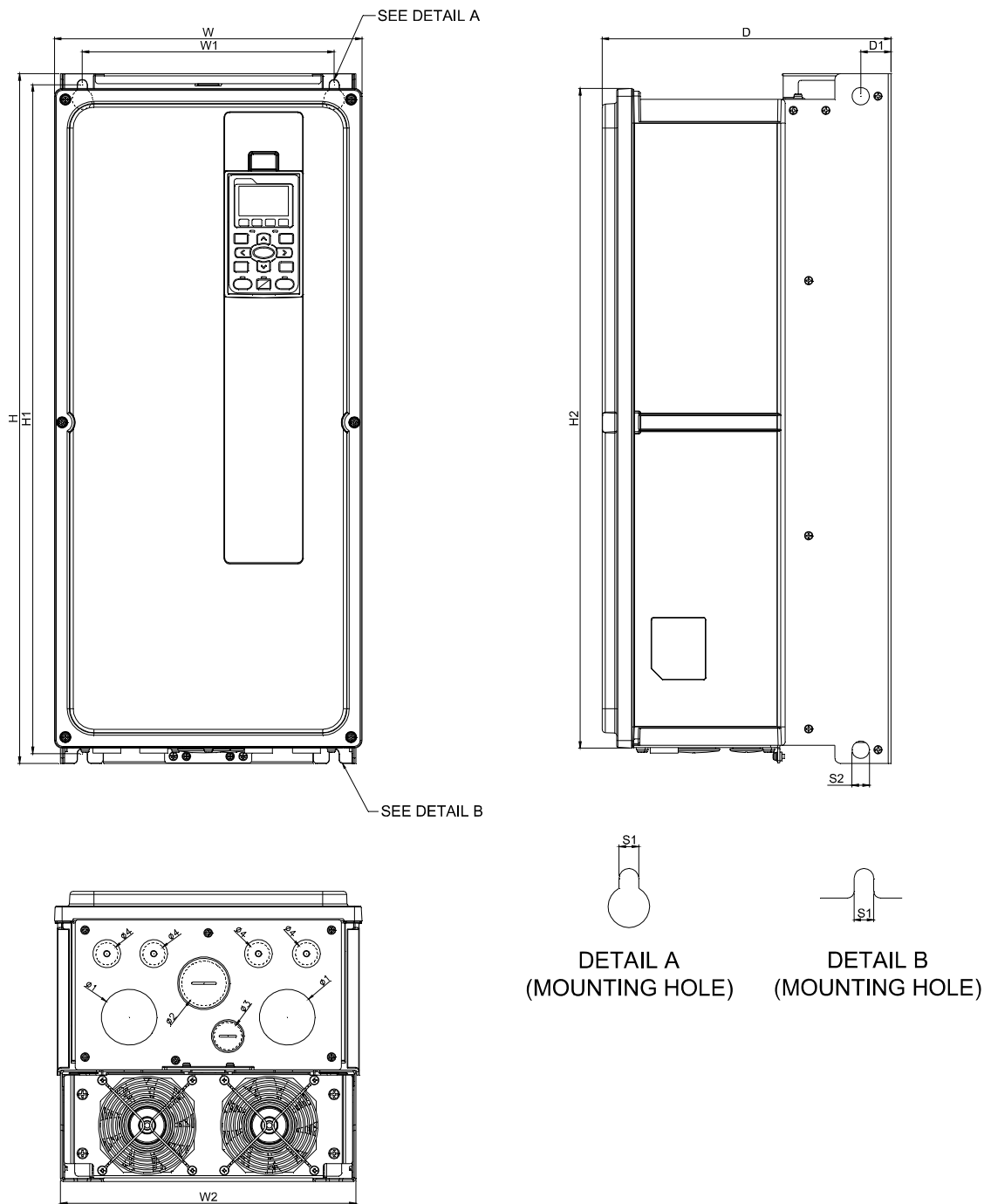

Unit: mm [inch]

Frame	W	W1	W2	H	H1	H2	D
C-1	282.0 [11.10]	231.0 [9.09]	271.0 [10.67]	630.0 [24.8]	611.0 [24.06]	602.5 [23.72]	265.0 [10.43]

Frame	D1	S1	S2	Φ1	Φ2	Φ3	Φ4
C-1	27.8 [1.09]	9.0 [0.35]	16.0 [0.63]	51.0 [2.01]	41.0 [1.61]	25.4 [1.00]	20.3 [0.80]

Frame C

C-2: VFD300FP4EA-52S, VFD370FP4EA-52S

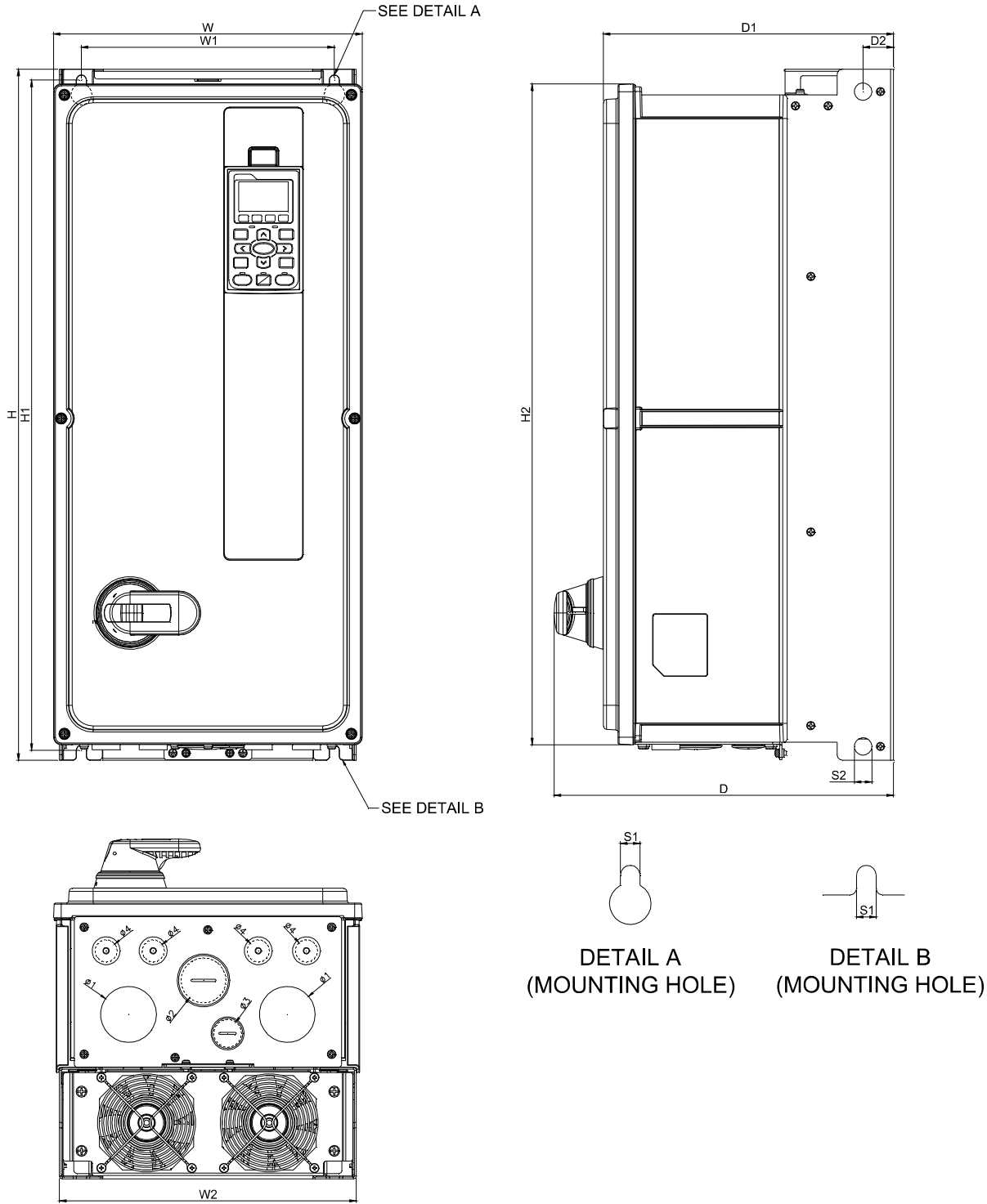

Unit: mm [inch]

Frame	W	W1	W2	H	H1	H2	D	D1
C-2	282.0 [11.10]	231.0 [9.09]	271.0 [10.67]	630.0 [24.8]	611.0 [24.06]	602.5 [23.72]	310.0 [12.20]	265.0 [10.43]

Frame	D2	S1	S2	Φ1	Φ2	Φ3	Φ4
C-2	27.8 [1.09]	9.0 [0.35]	16.0 [0.63]	51.0 [2.01]	41.0 [1.61]	25.4 [1.00]	20.3 [0.80]

Frame C

C-3: VFD300FP4EA-41, VFD370FP4EA-41

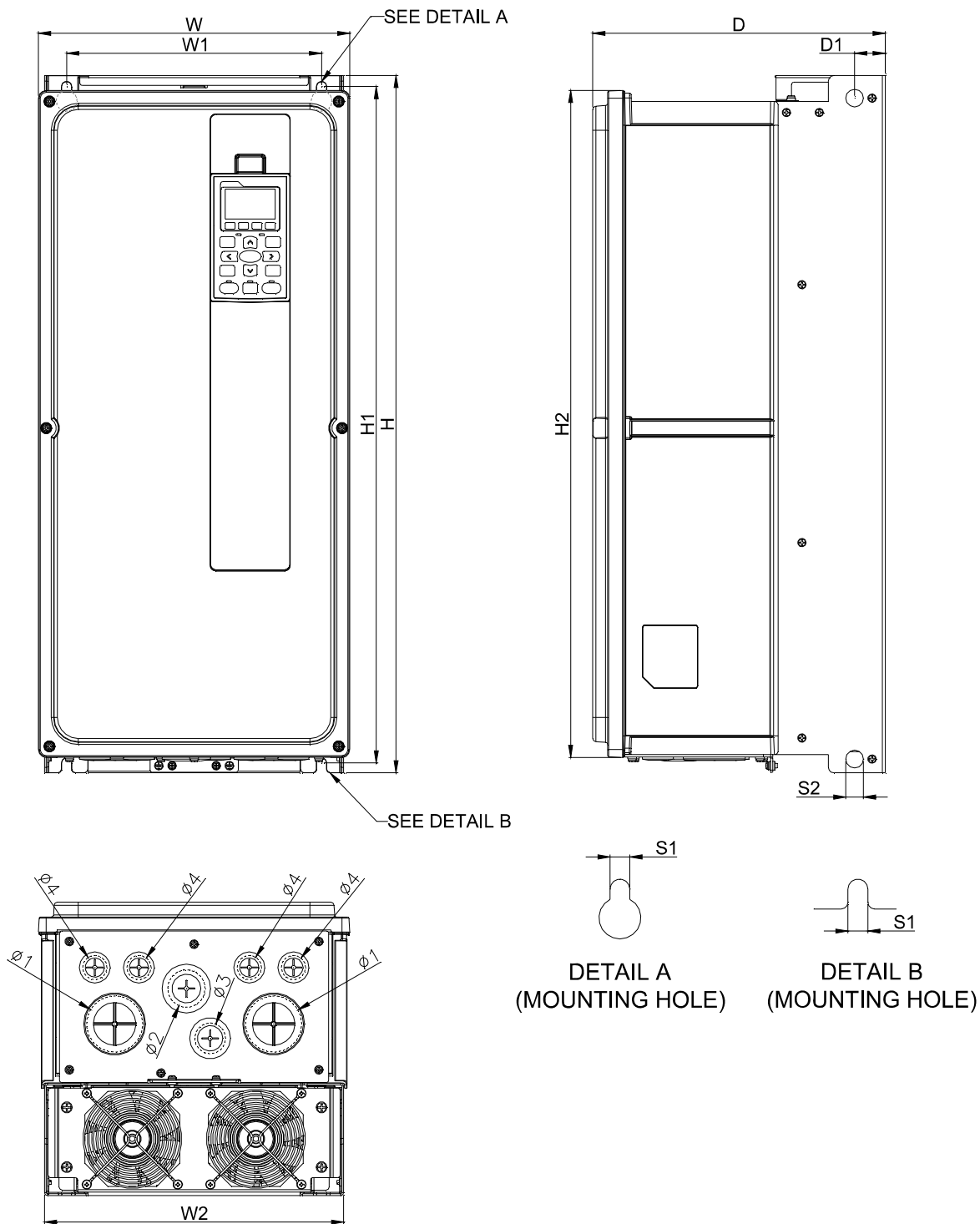

Unit: mm [inch]

Frame	W	W1	W2	H	H1	H2	D
C-3	282.0 [11.10]	231.0 [9.09]	271.0 [10.67]	630.0 [24.80]	611.0 [24.06]	602.5 [23.72]	265.0 [10.43]

Frame	D1	S1	S2	Φ1	Φ2	Φ3	Φ4
C-3	27.8 [1.09]	9.0 [0.35]	16.0 [0.63]	51.0 [2.01]	34.0 [1.34]	28.0 [1.10]	22.0 [0.87]

Frame D0

D0-1: VFD450FP4EA-52, VFD550FP4EA-52

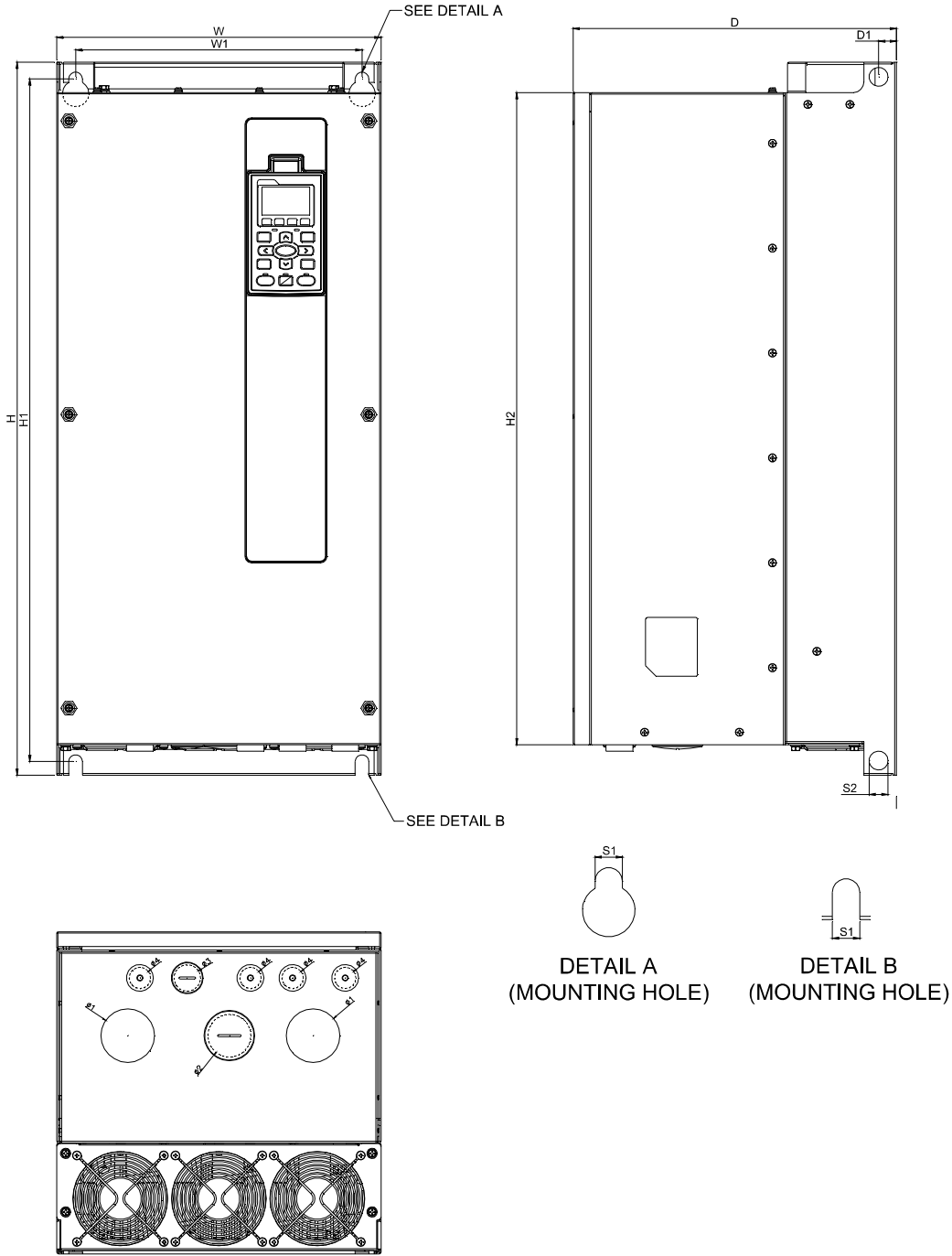

Unit: mm [inch]

Frame	W	W1	H	H1	H2	D
D0-1	308.0 [12.13]	272.0 [10.71]	680.0 [26.77]	651.0 [25.63]	622.0 [24.49]	307.0 [12.09]

Frame	D1	S1	S2	Φ1	Φ2	Φ3	Φ4
D0-1	17.0 [0.67]	13.0 [0.51]	18.0 [0.71]	51.0 [2.01]	41.0 [1.61]	25.4 [1.00]	20.3 [0.80]

Frame D0

D0-2: VFD450FP4EA-52S, VFD550FP4EA-52S

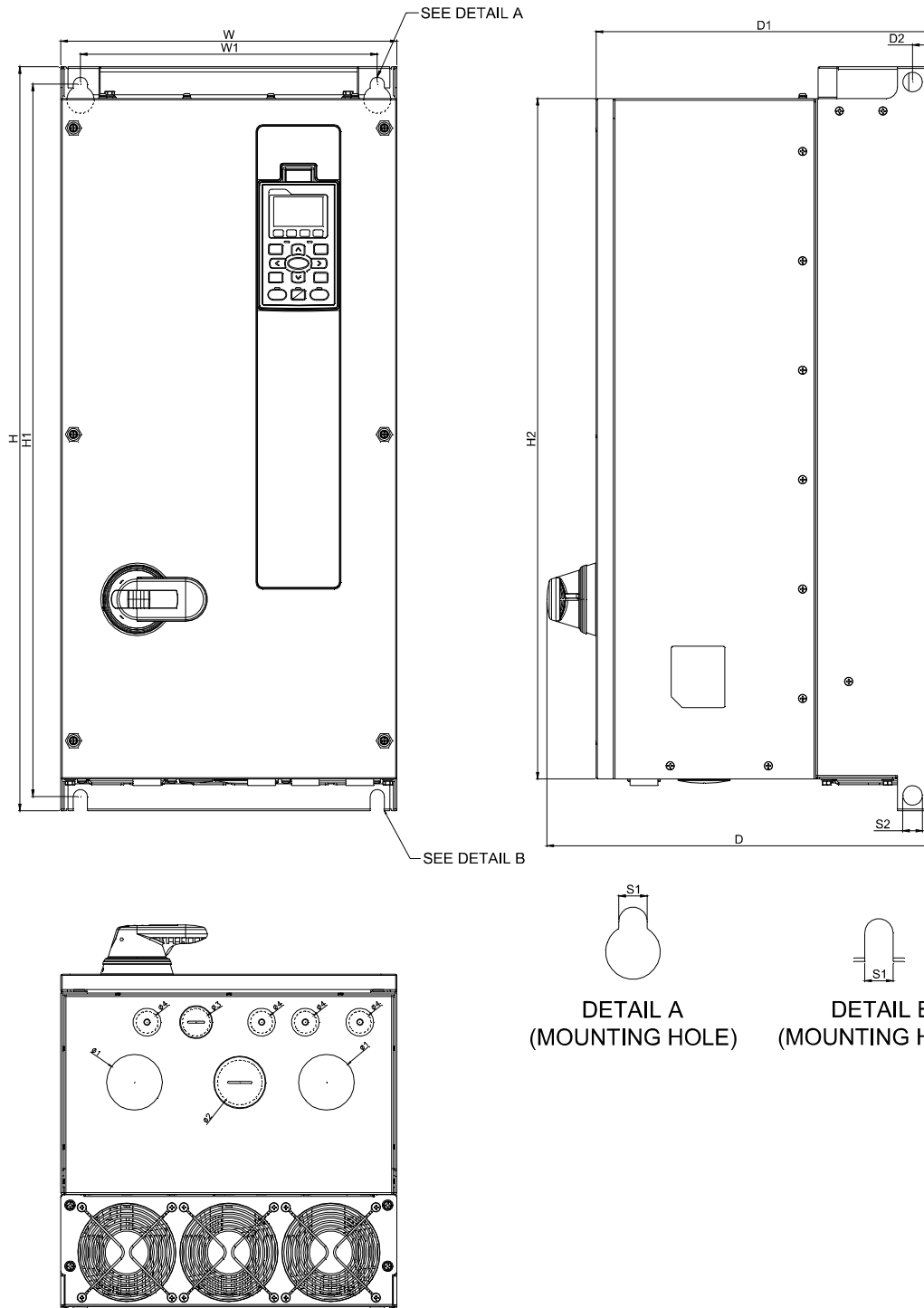

Unit: mm [inch]

Frame	W	W1	H	H1	H2	D	D1
D0-2	308.0 [12.13]	272.0 [10.71]	680.0 [26.77]	651.0 [25.63]	622.0 [24.49]	352.0 [13.86]	307.0 [12.09]

Frame	D2	S1	S2	Φ1	Φ2	Φ3	Φ4
D0-2	17.0 [0.67]	13.0 [0.51]	18.0 [0.71]	51.0 [2.01]	41.0 [1.61]	25.4 [1.00]	20.3 [0.80]

Frame D0

D0-3: VFD450FP4EA-41, VFD550FP4EA-41

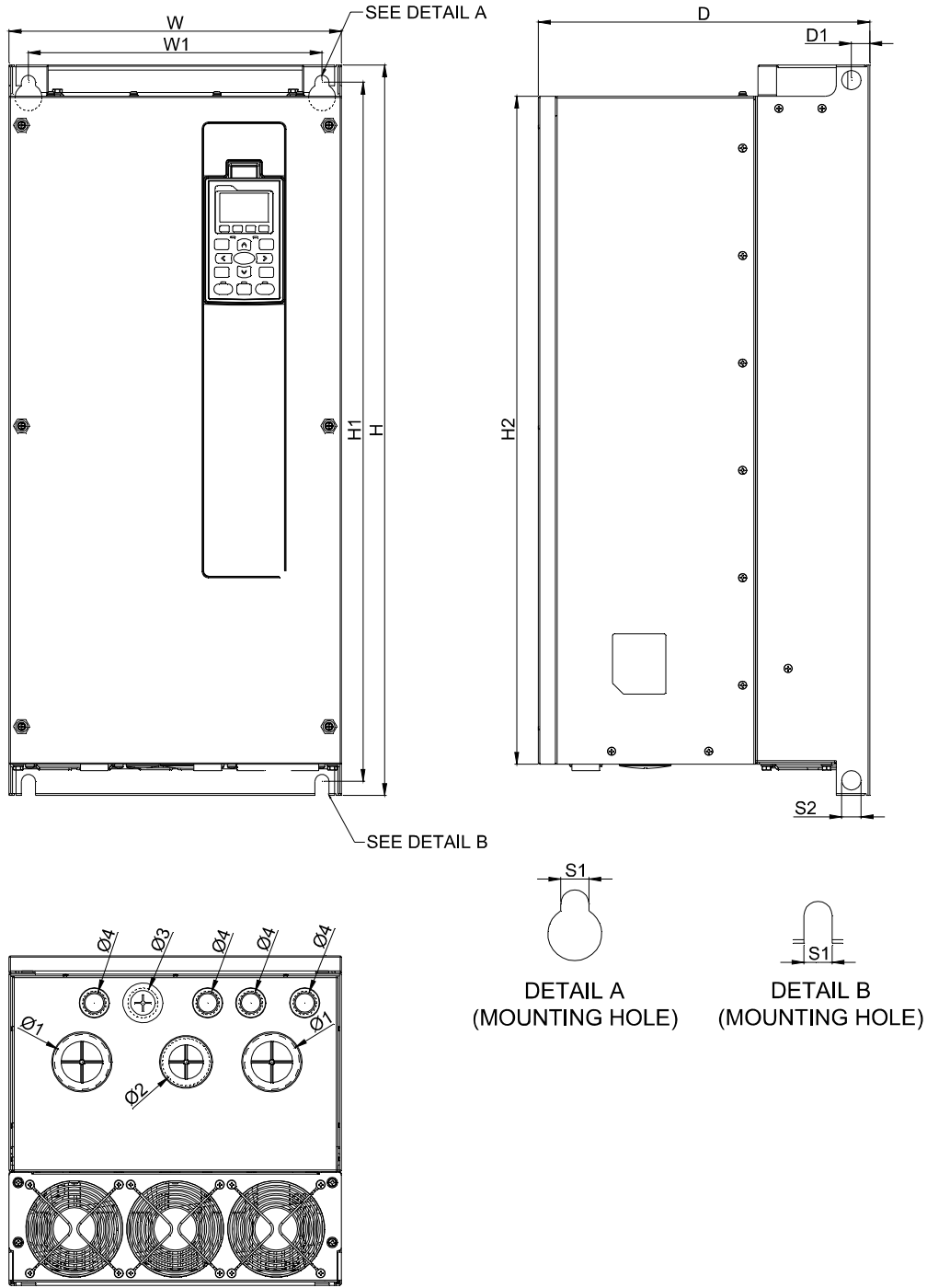

Unit: mm [inch]

Frame	W	W1	H	H1	H2	D
D0-3	308.0 [12.13]	272.0 [10.71]	680.0 [26.77]	651.0 [25.63]	622.0 [24.49]	307.0 [12.09]

Frame	D1	S1	S2	Φ1	Φ2	Φ3	Φ4
D0-3	17.0 [0.67]	13.0 [0.51]	18.0 [0.71]	51.0 [2.01]	44.0 [1.73]	28.0 [1.10]	22.0 [0.87]

Frame D

D-1: VFD750FP4EA-52, VFD900FP4EA-52

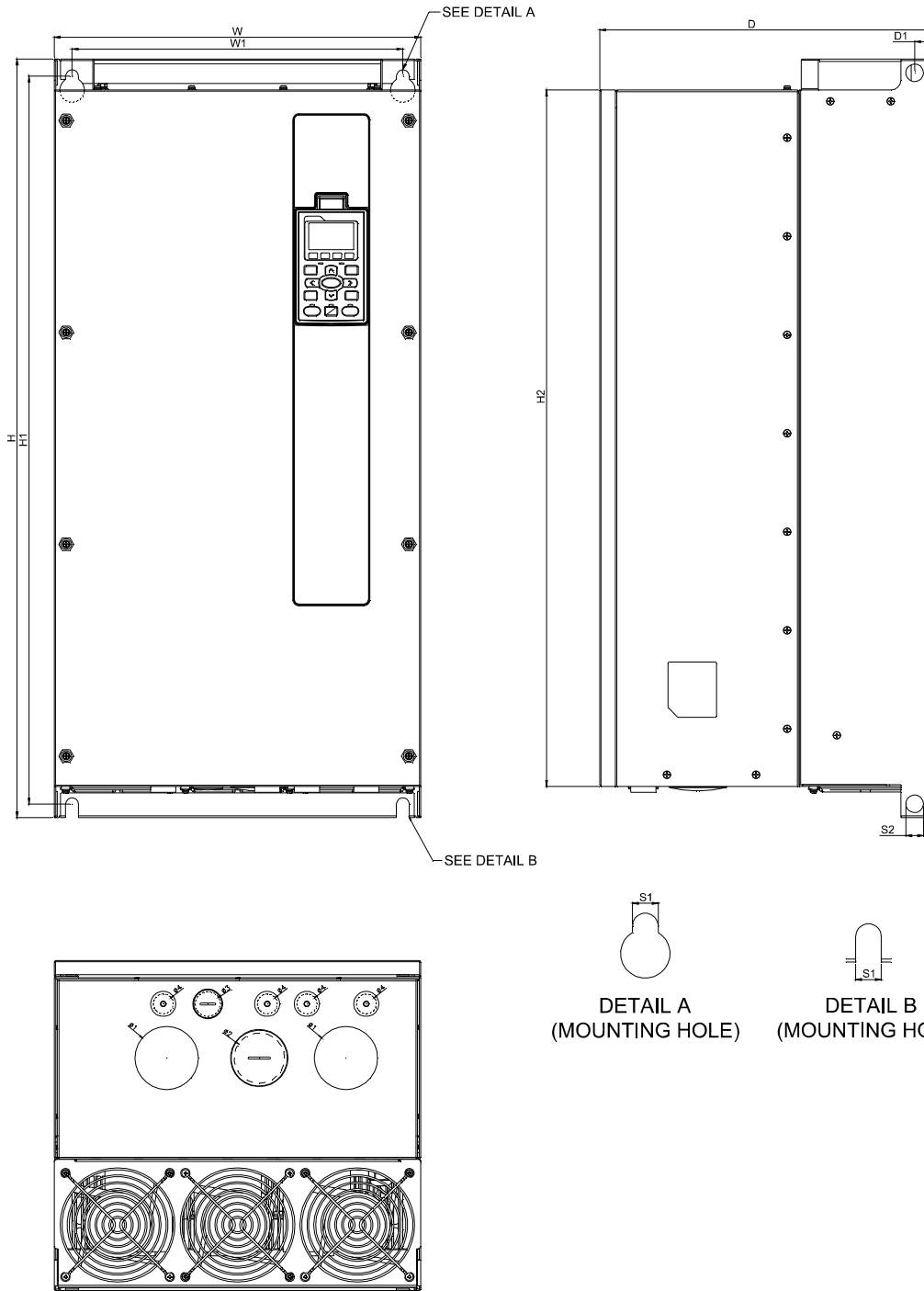

Unit: mm [inch]

Frame	W	W1	H	H1	H2	D
D-1	370.0 [14.57]	334.0 [13.15]	770.0 [30.31]	739.0 [29.09]	707.0 [27.83]	335.0 [13.19]

Frame	D1	S1	S2	Φ1	Φ2	Φ3	Φ4
D-1	17.0 [0.67]	13.0 [0.51]	18.0 [0.71]	64.0 [2.52]	51.0 [2.01]	25.4 [1.00]	20.3 [0.80]

Frame D

D-2: VFD750FP4EA-52S, VFD900FP4EA-52S

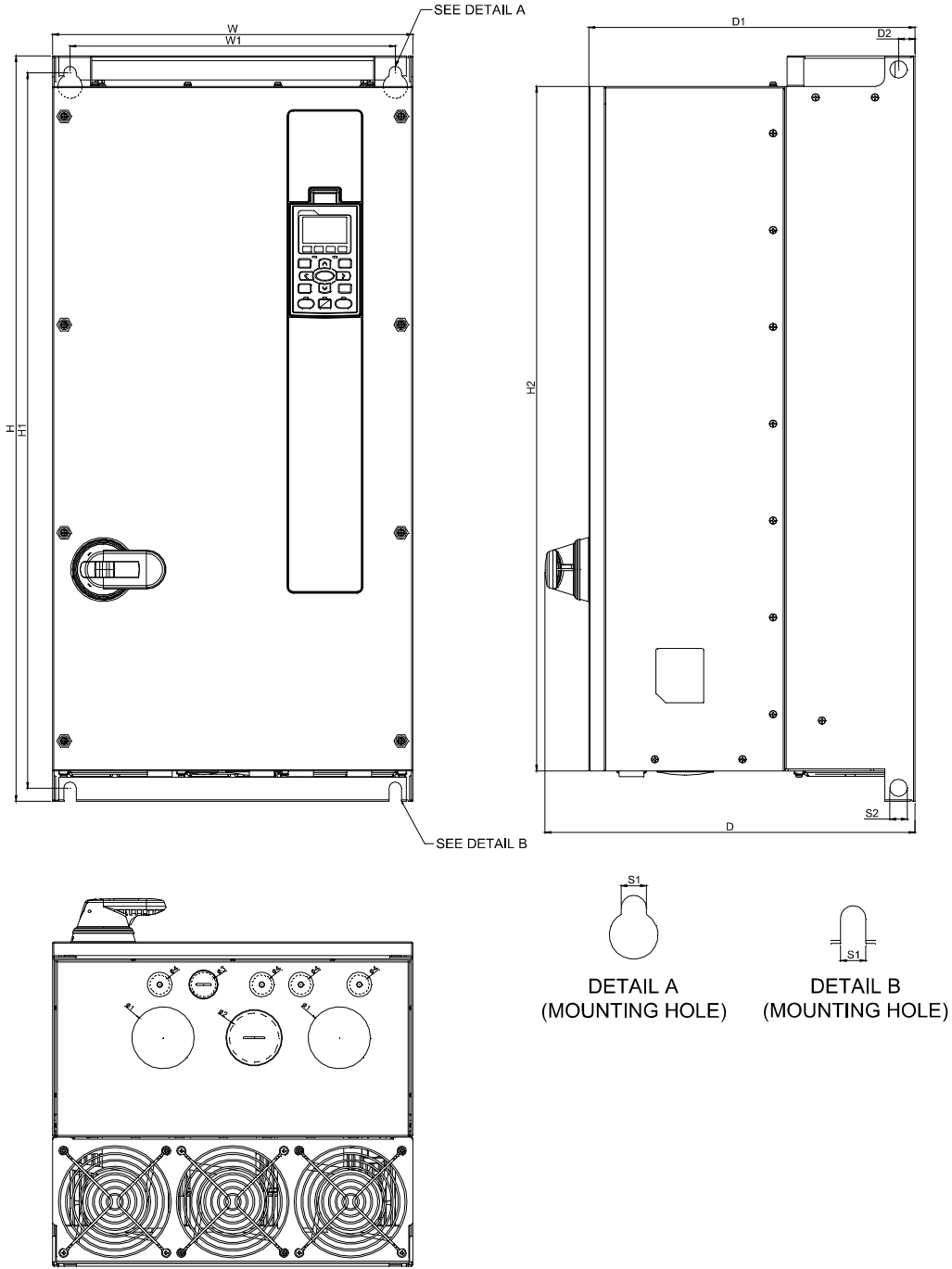

Unit: mm [inch]

Frame	W	W1	H	H1	H2	D	D1
D-2	370.0 [14.57]	334.0 [13.15]	770.0 [30.31]	739.0 [29.09]	707.0 [27.83]	380.0 [14.96]	335.0 [13.19]

Frame	D2	S1	S2	Φ1	Φ2	Φ3	Φ4
D-2	17.0 [0.67]	13.0 [0.51]	18.0 [0.71]	64.0 [2.52]	51.0 [2.01]	25.4 [1.00]	20.3 [0.80]

Frame D

D-3: VFD750FP4EA-41, VFD900FP4EA-41

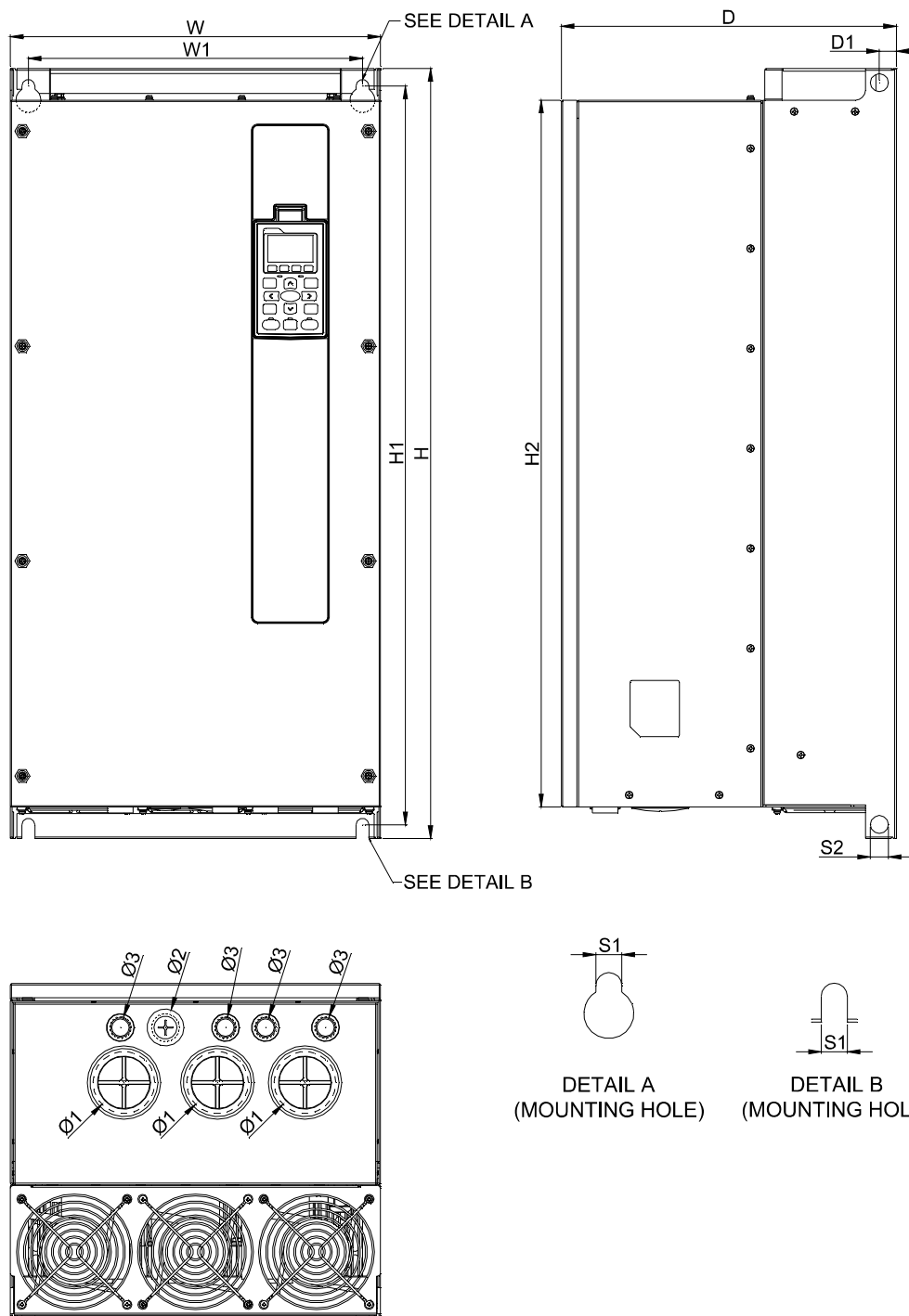

Unit: mm [inch]

Frame	W	W1	H	H1	H2	D
D-3	370.0 [14.57]	334.0 [13.15]	770.0 [30.31]	739.0 [29.09]	707.0 [27.83]	335.0 [13.19]

Frame	D1	S1	S2	Φ1	Φ2	Φ3	Φ4
D-3	17.0 [0.67]	13.0 [0.51]	18.0 [0.71]	62.0 [2.44]	28.0 [1.10]	22.0 [0.87]	—

Digital Keypad
KPC-CC02

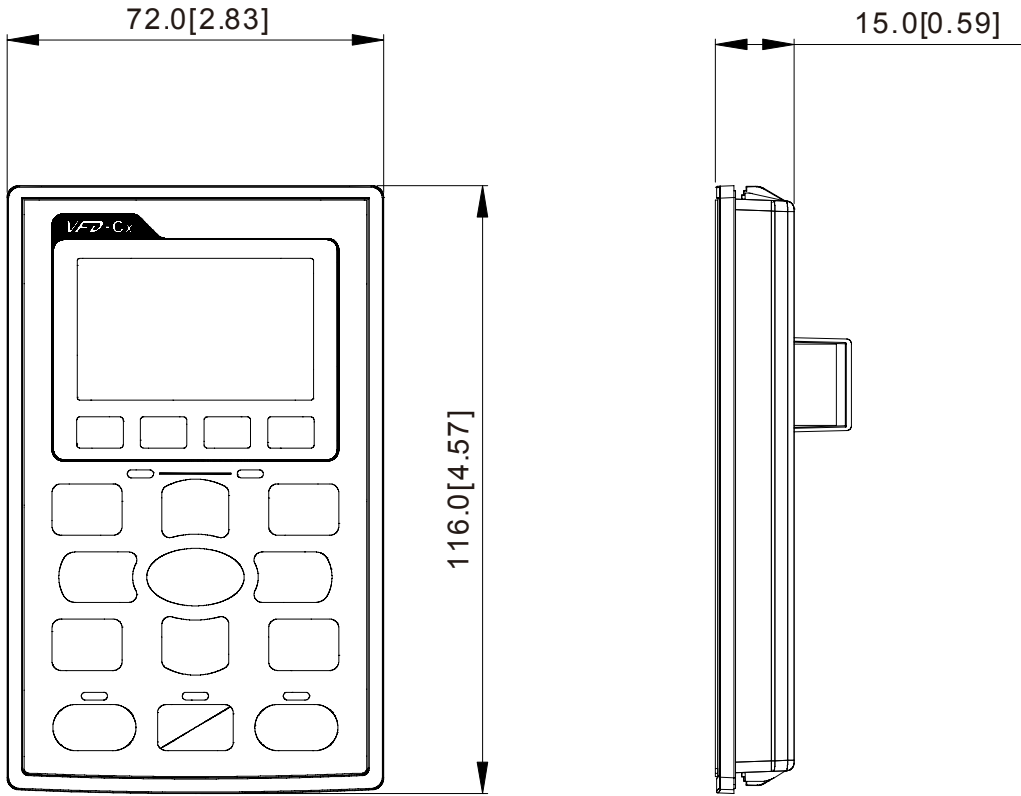

Chapter 2 Installation

2-1 Minimum Mounting Clearance and Installation

NOTE

- ☑ Prevent fiber particles, scraps of paper, shredded wood saw dust, metal particles, etc. from adhering to the heat sink
- ☑ Install the AC motor drive in a metal cabinet. When installing one drive below another one, use a metal separation between the AC motor drives to prevent mutual heating and to prevent the risk of fire accident.
- ☑ Install the AC motor drive in Pollution Degree 2 environments only: normally only nonconductive pollution occurs and temporary conductivity caused by condensation is expected.

The appearances shown in the following figures are for reference only.

Airflow direction:  (Blue arrow) inflow  (Red arrow) outflow  (Black) distance

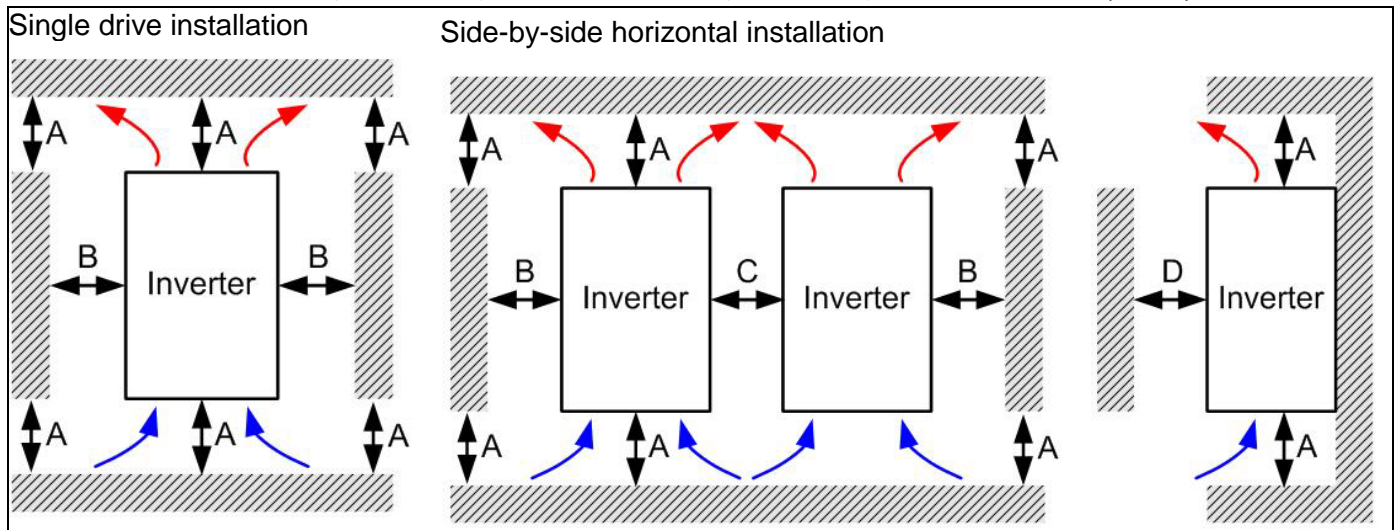

Multiple drives side-by-side vertical installation

When installing one AC motor drive below another one (top-bottom installation), use a metal separation between the drives to prevent mutual heating. The temperature measured at the fan's inflow side must be lower than the temperature measured at the operation side. If the fan's inflow temperature is higher, use a thicker or larger size of metal partition. Operation temperature is the temperature measured at 50mm away from the fan's inflow side. (As shown in the figure below)

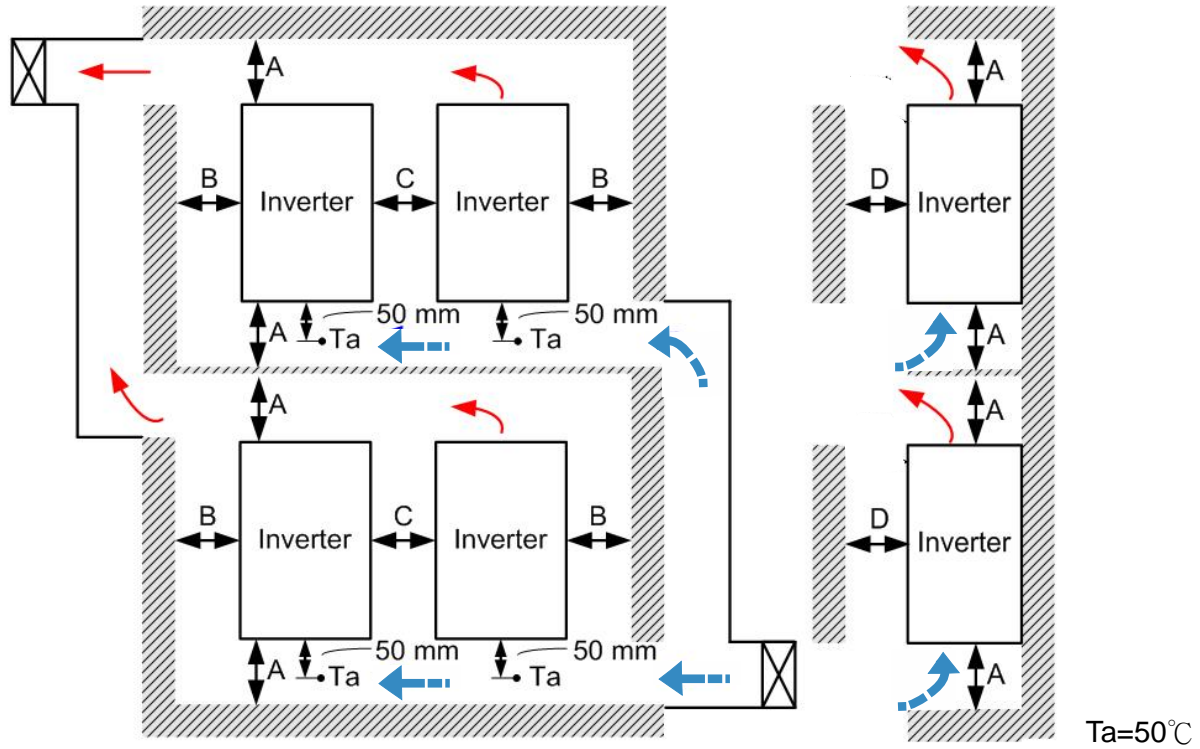

2-2 Minimum mounting clearance

Frame	A (mm)	B (mm)	C (mm)	D (mm)
A~B	60	15	-	-
C~D	100	25	-	-

Frame A	VFD007FP4EA-41, VFD007FP4EA-52, VFD007FP4EA-52S, VFD015FP4EA-41, VFD015FP4EA-52, VFD015FP4EA-52S, VFD022FP4EA-41, VFD022FP4EA-52, VFD022FP4EA-52S, VFD037FP4EA-41, VFD037FP4EA-52, VFD037FP4EA-52S, VFD040FP4EA-41, VFD040FP4EA-52, VFD040FP4EA-52S, VFD055FP4EA-41, VFD055FP4EA-52, VFD055FP4EA-52S, VFD075FP4EA-41, VFD075FP4EA-52, VFD075FP4EA-52S
Frame B	VFD110FP4EA-41, VFD110FP4EA-52, VFD110FP4EA-52S, VFD150FP4EA-41, VFD150FP4EA-52, VFD150FP4EA-52S, VFD185FP4EA-41, VFD185FP4EA-52, VFD185FP4EA-52S, VFD220FP4EA-41, VFD220FP4EA-52, VFD220FP4EA-52S
Frame C	VFD300FP4EA-41, VFD300FP4EA-52, VFD300FP4EA-52S, VFD370FP4EA-41, VFD370FP4EA-52, VFD370FP4EA-52S
Frame D0	VFD450FP4EA-41, VFD450FP4EA-52, VFD450FP4EA-52S, VFD550FP4EA-41, VFD550FP4EA-52, VFD550FP4EA-52S
Frame D	VFD750FP4EA-41, VFD750FP4EA-52, VFD750FP4EA-52S, VFD900FP4EA-41, VFD900FP4EA-52, VFD900FP4EA-52S

 **NOTE**

- The minimum mounting clearances stated in the table above applies to AC motor drives frame A to D. A drive fails to follow the minimum mounting clearances may cause the fan to malfunction and heat dissipation problem.

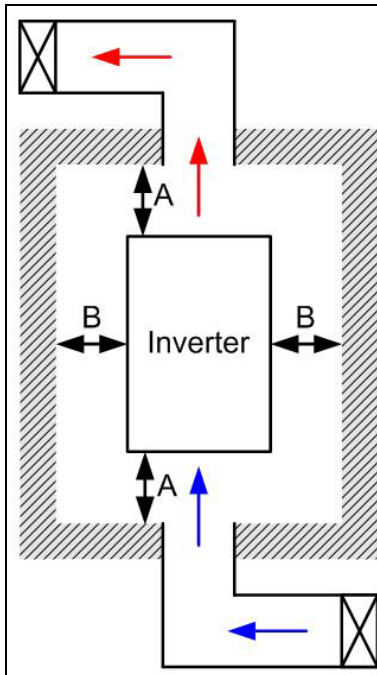
 **NOTE**

- ※ The mounting clearance stated in the figure is for installing the drive in an open area. To install the drive in a confined space (such as cabinet or electric box), please follow the following three rules: (1) Keep the minimum mounting clearances. (2) Install a ventilation equipment or an air conditioner to keep surrounding temperature lower than operation temperature.
- ※ The following table shows the heat dissipation and the required air volume when installing a single drive in a confined space. When installing multiple drives, the required air volume shall be multiplied by the number the drives.
- ※ Refer to the chart (Air flow rate for cooling) for ventilation equipment design and selection.
- ※ Refer to the chart (Power dissipation) for air conditioner design and selection.

Model No.	Air flow rate for cooling			Power dissipation of AC motor drive		
	Flow Rate (cfm)			Power Dissipation (watt)		
	External	Internal	Total	Loss External	Internal	Total
VFD007FP4EA-41/ 52 / 52S	-	14	14	32	20	52
VFD015FP4EA-41/ 52 / 52S	-	14	14	43	21	64
VFD022FP4EA-41/ 52 / 52S	34	14	48	74	25	99
VFD037FP4EA-41/ 52 / 52S	34	14	48	92	26	118
VFD040FP4EA-41/ 52 / 52S	34	14	48	113	26	139
VFD055FP4EA-41/ 52 / 52S	34	14	48	139	27	166
VFD075FP4EA-41/ 52 / 52S	34	14	48	195	29	224
VFD110FP4EA-41/ 52 / 52S	88	14	102	240	34	274
VFD150FP4EA-41/ 52 / 52S	88	14	102	309	38	347
VFD185FP4EA-41/ 52 / 52S	88	14	102	353	39	392
VFD220FP4EA-41/ 52 / 52S	88	14	102	449	47	496
VFD300FP4EA-41/ 52 / 52S	200	29	229	618	84	702
VFD370FP4EA-41/ 52 / 52S	200	29	229	726	87	813
VFD450FP4EA-41/ 52 / 52S	285	29	314	864	82	946
VFD550FP4EA-41/ 52 / 52S	285	29	314	1068	84	1152
VFD750FP4EA-41/ 52 / 52S	330	29	359	1407	111	1518
VFD900FP4EA-41/ 52 / 52S	330	29	359	1623	114	1737
	※ The required airflow shown in chart is for installing single drive in a confined space.			※ The heat dissipation shown in the chart is for installing single drive in a confined space.		

	※ When installing the multiple drives, the required air volume should be the required air volume for single drive X the number of the drives.	※ When installing the multiple drives, volume of heat dissipation should be the heat dissipated for single drive X the number of the drives.
--	---	--

 **NOTE**

Normal control Ambient temperature derating curve

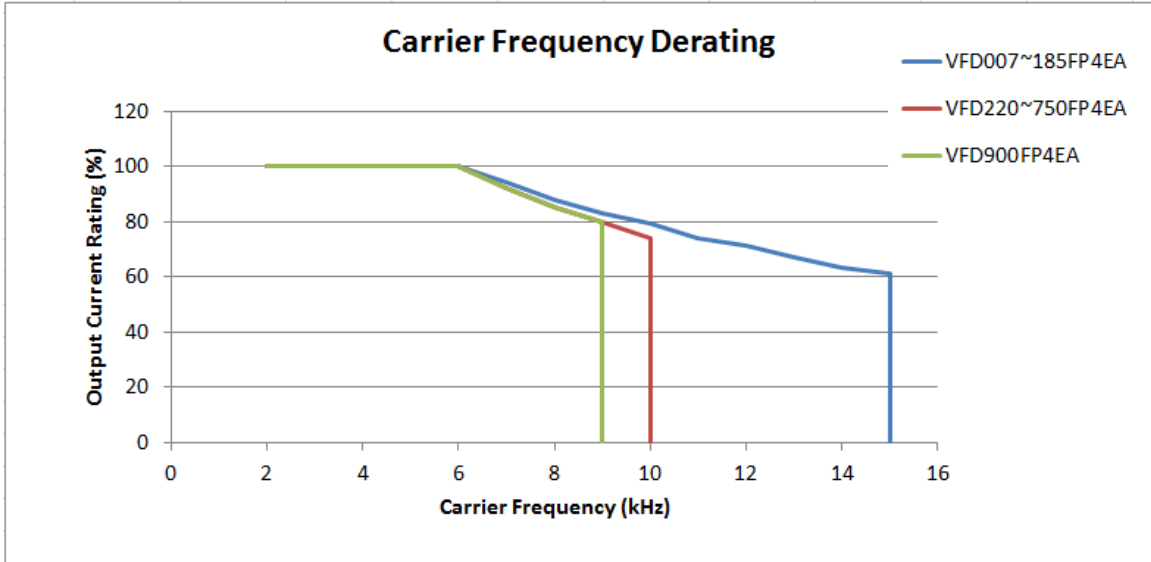

Chapter 3 Unpacking

The AC motor drive should be kept in the shipping carton or crate before installation. In order to retain the warranty coverage, the AC motor drive should be stored properly when it is not to be used for an extended period of time.

3-1 Unpacking

The AC motor drive is packed in the crate. Follows the following step for unpack:

Frame D0

VFD450FP4EA-41, VFD450FP4EA-52, VFD450FP4EA-52S,
VFD550FP4EA-41, VFD550FP4EA-52, VFD550FP4EA-52S

1. Removing the 4 clips by slotted screwdriver.

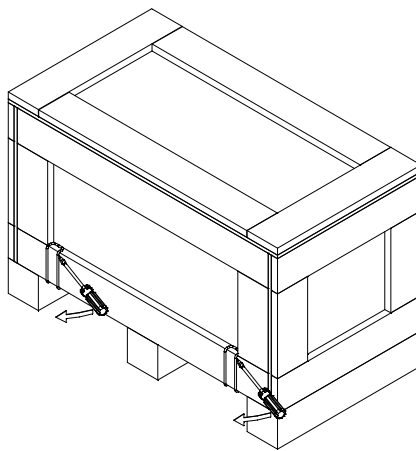

2. Removing the cover of wood box and then taking out the EPE tray and user manual.

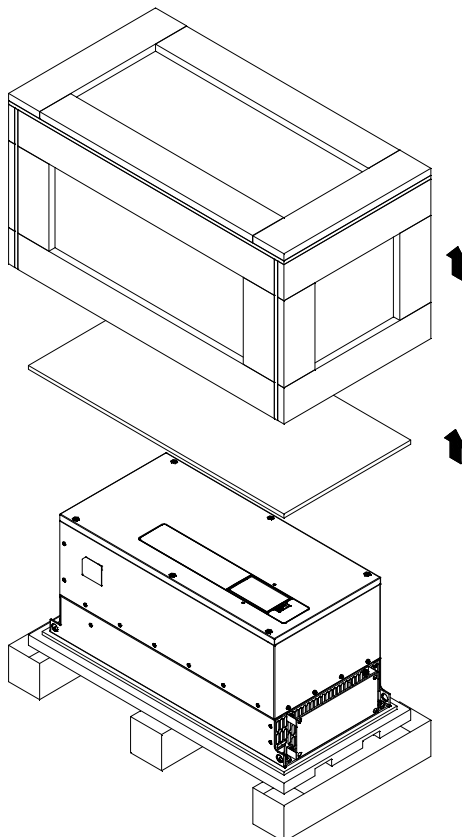

3. Loosen the 5 screws that fastened on the pallet.

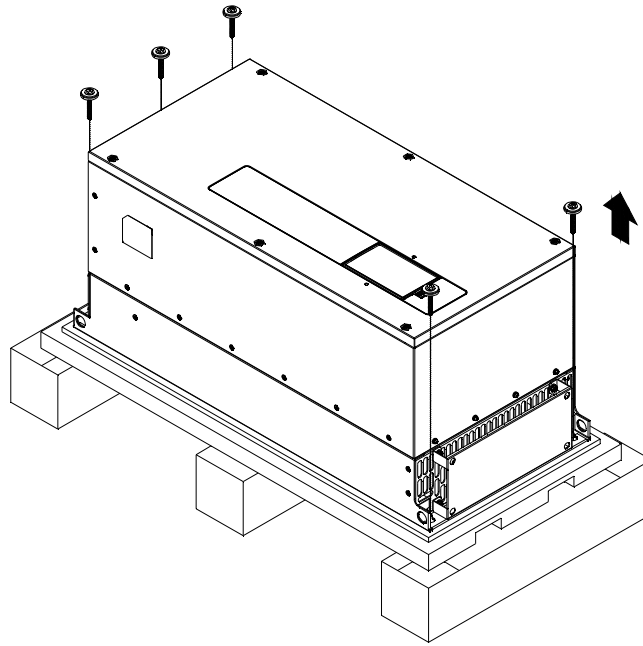

4. Lifting up the drive by using hooks through the holes.

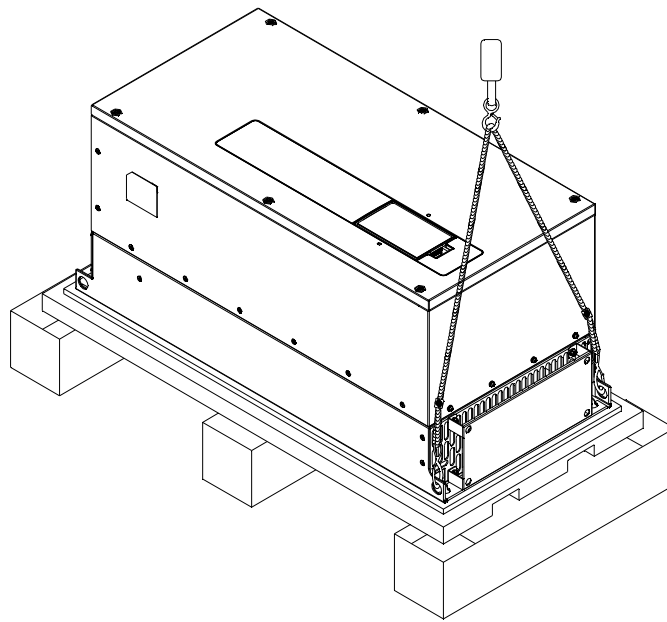

Frame D

VFD750FP4EA-41, VFD750FP4EA-52, VFD750FP4EA-52S,
VFD900FP4EA-41, VFD900FP4EA-52, VFD900FP4EA-52S

1. Removing the 6 clips by slotted screwdriver.

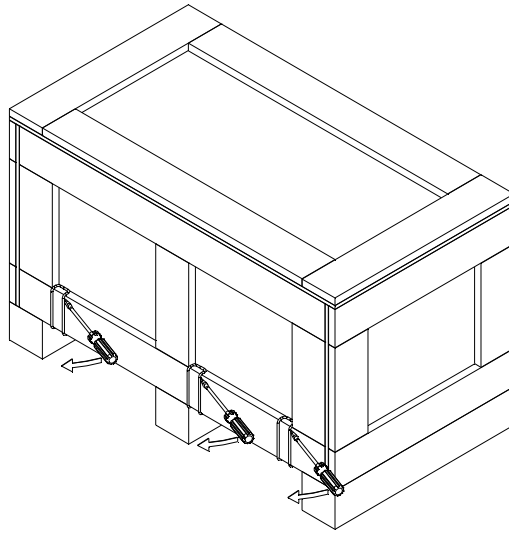

2. Removing the cover of wood box and then taking out the EPE tray and user manual.

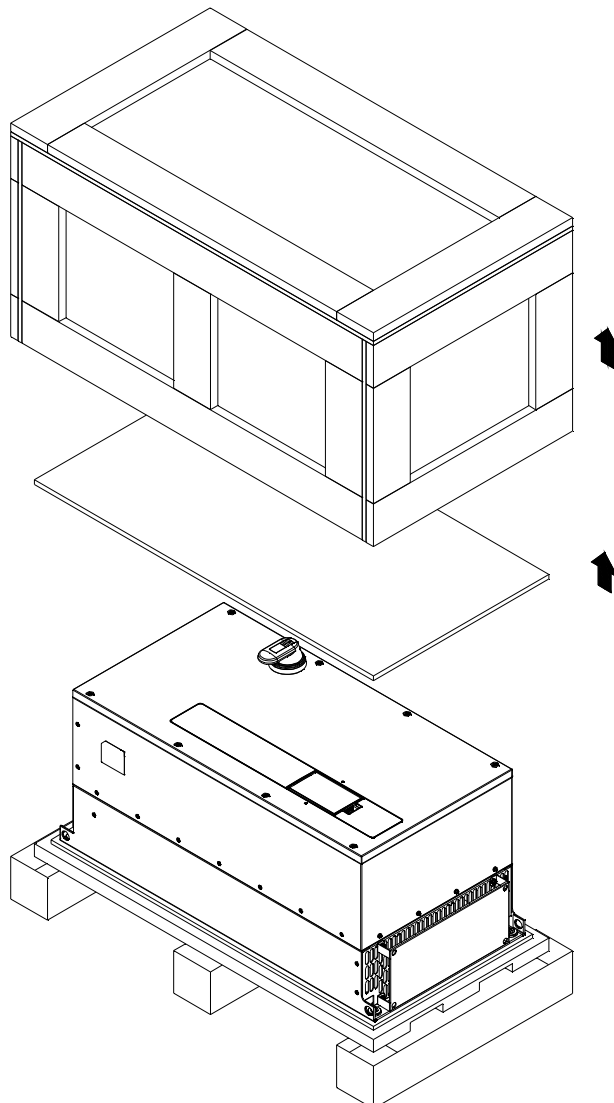

3. Loosen the 5 screws that fastened on the pallet.

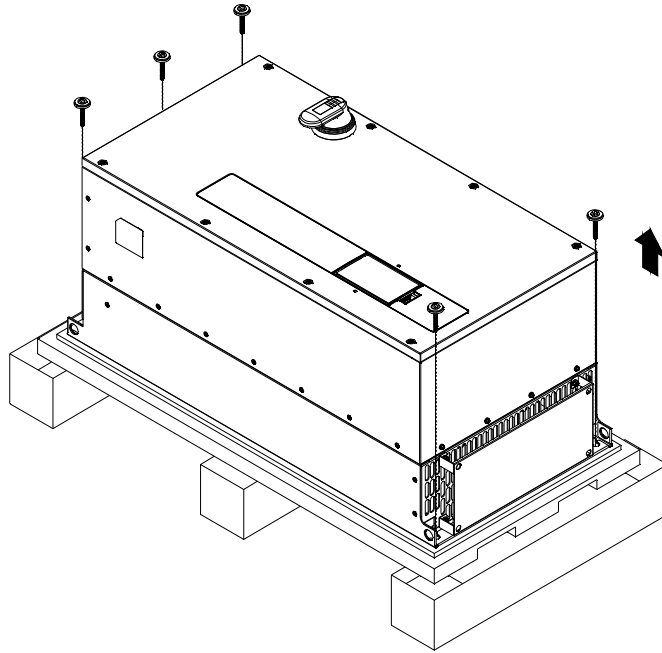

4. Lifting up the drive by using hooks through the holes.

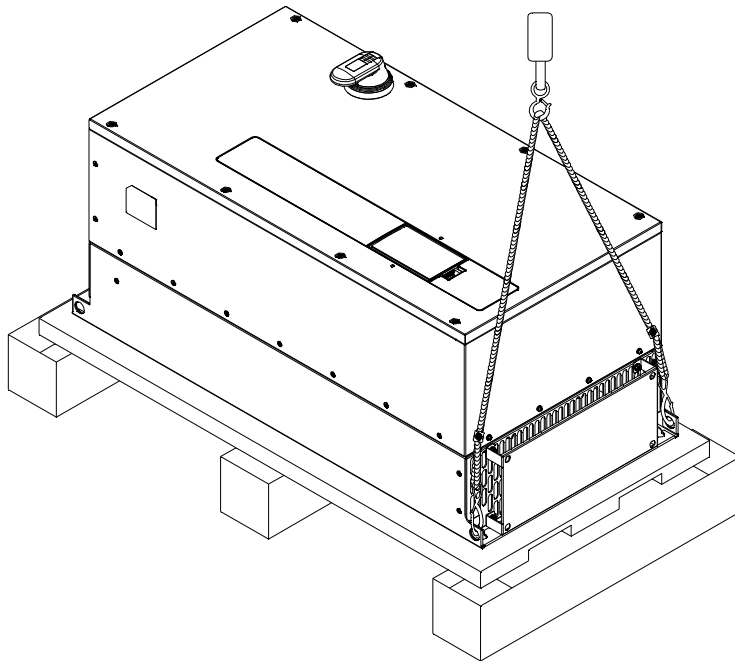

3-2 The Lifting Hook

The arrows indicate the location of the lifting holes, as shown in figure below:

Frame D0

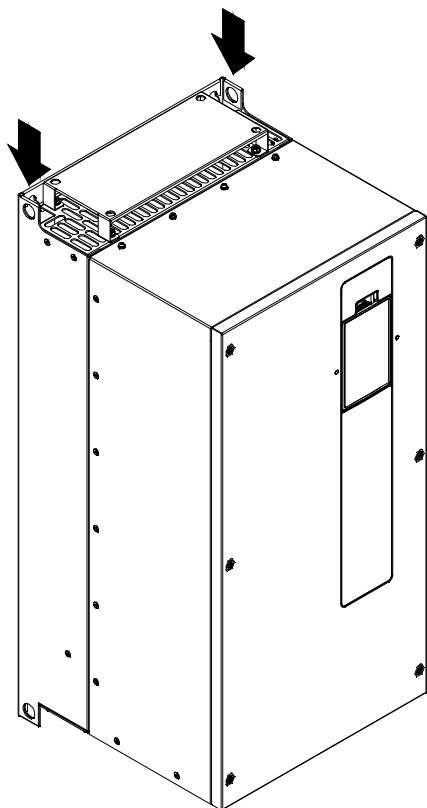

Frame D

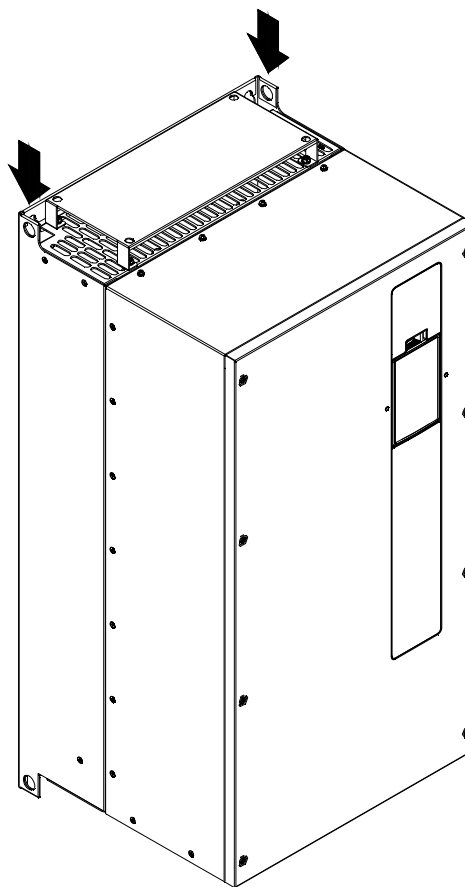

Ensure the lifting hook properly goes through the lifting hole, as shown in the following diagram.

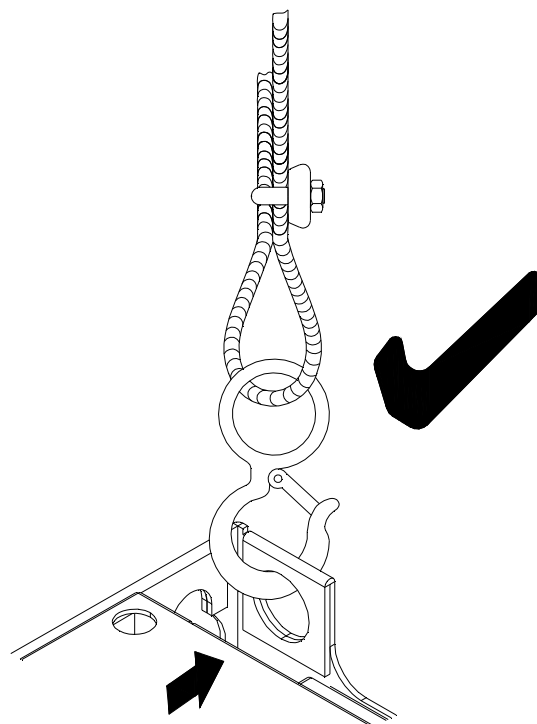
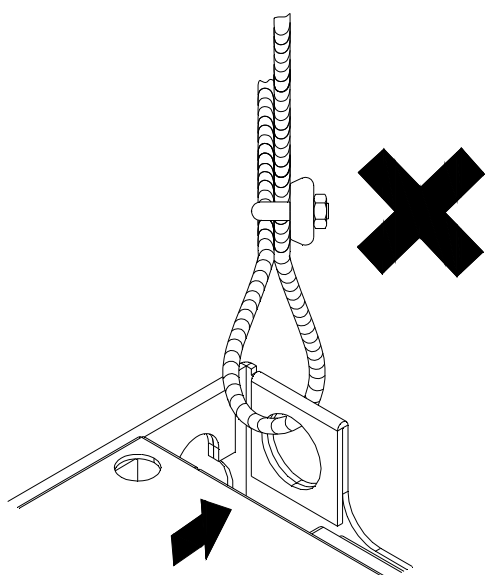

Ensure the angle between the lifting holes and the lifting device is within the specification, as shown in the following figure.

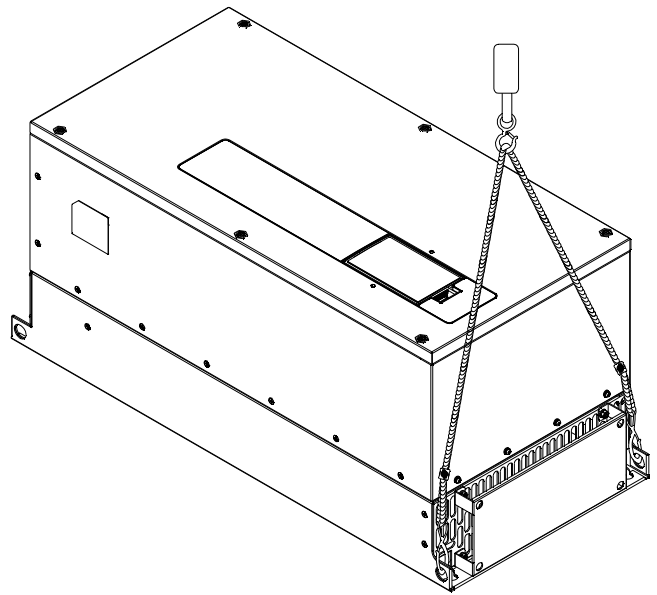
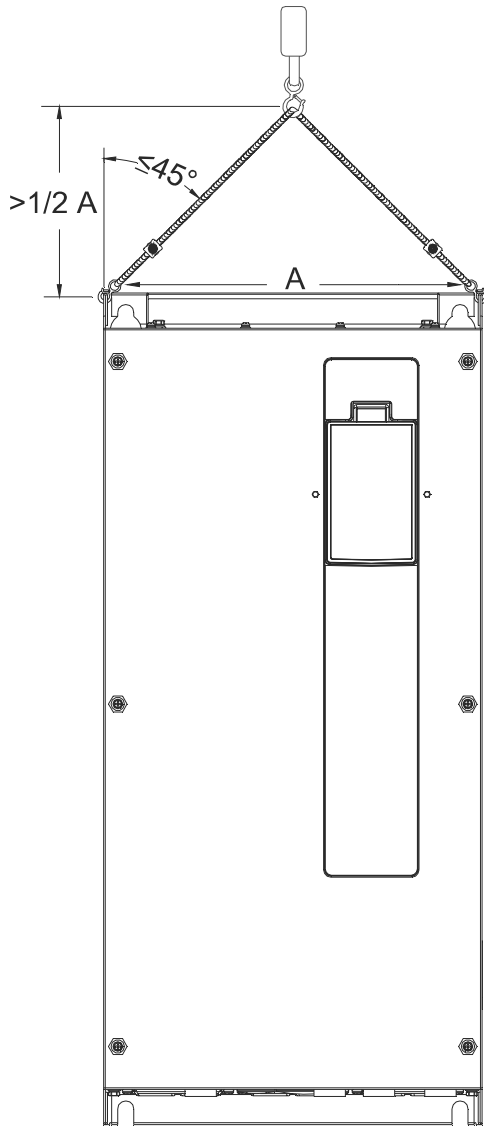

Weight

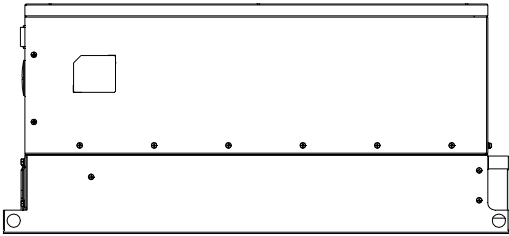
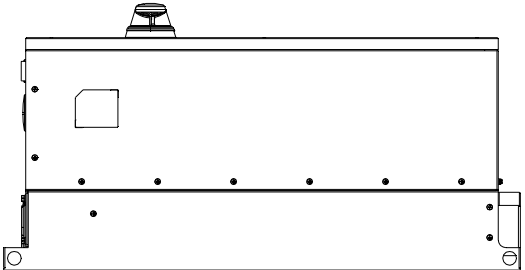
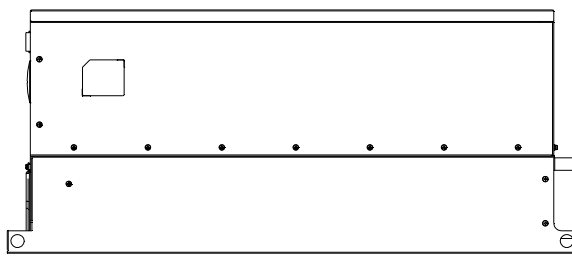
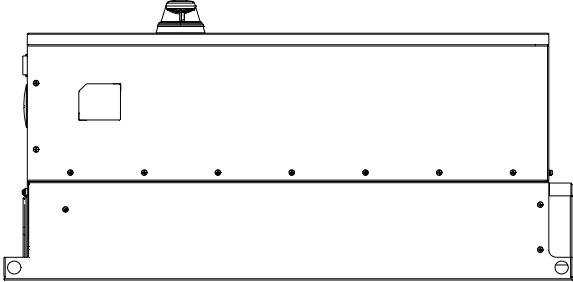
Frame	VFDXXXFP4EA-52	VFDXXXFP4EA-52S
D0	<p>41.5 kg (91.4 lbs.)</p> 	<p>41.7 kg (91.9 lbs.)</p> 
D	<p>59.0 kg (130.0 lbs.)</p> 	<p>60.2 kg (132.6 lbs.)</p> 

[The page intentionally left blank]

Chapter 4 Wiring

After removing the front cover, examine if the power and control terminals are clearly noted. Please read following precautions before wiring.



- ☑ It is crucial to turn off the AC motor drive power before any wiring installations are made. A charge may still remain in the DC bus capacitors with hazardous voltages even if the power has been turned off therefore it is suggested for users to measure the remaining voltage before wiring. For your personnel safety, please do not perform any wiring before the voltage drops to a safe level < 25 Vdc. Wiring installation with remaining voltage condition may cause sparks and short circuit.
- ☑ Only qualified personnel familiar with AC motor drives is allowed to perform installation, wiring and commissioning. Make sure the power is turned off before wiring to prevent electric shock.
- ☑ Make sure that power is only applied to the R/L1, S/L2, and T/L3 terminals. Failure to comply may result in damage to the equipments. The voltage and current should lie within the range as indicated on the nameplate (Chapter 1-1).
- ☑ All the units must be grounded directly to a common ground terminal to prevent lightning strike or electric shock.
- ☑ Please make sure to fasten the screw of the main circuit terminals to prevent sparks which is made by the loose screws due to vibration



- ☑ When wiring, please choose the wires with specification that complies with local regulation for your personnel safety.
- ☑ Check following items after finishing the wiring:
 1. Are all connections correct?
 2. Any loosen wires?
 3. Any short-circuits between the terminals or to ground?

4-1 Wiring

Wiring Diagram for Frame A~C

*It provides 3-phase power

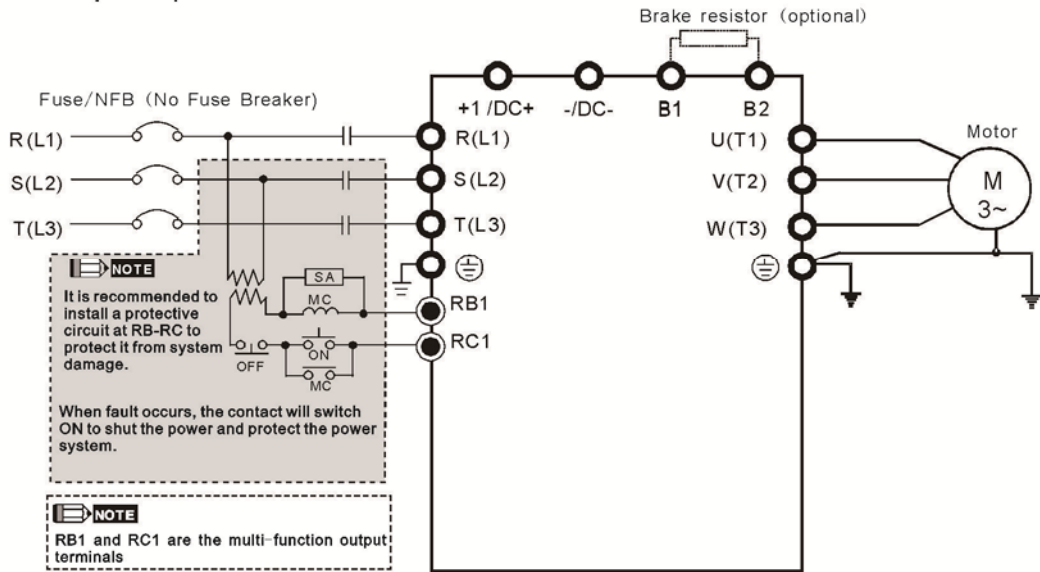

Wiring Diagram for Frame D0 and above

*It provides 3-phase power

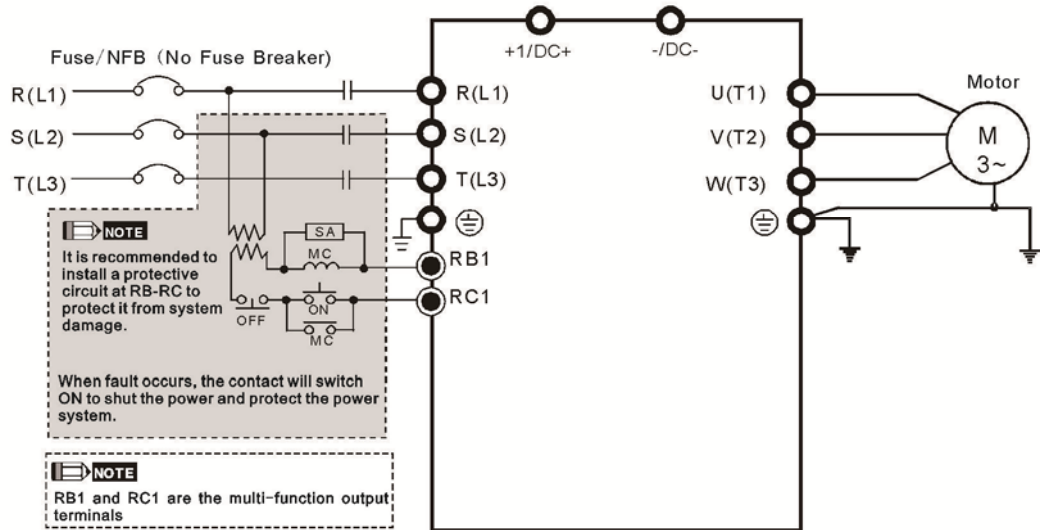

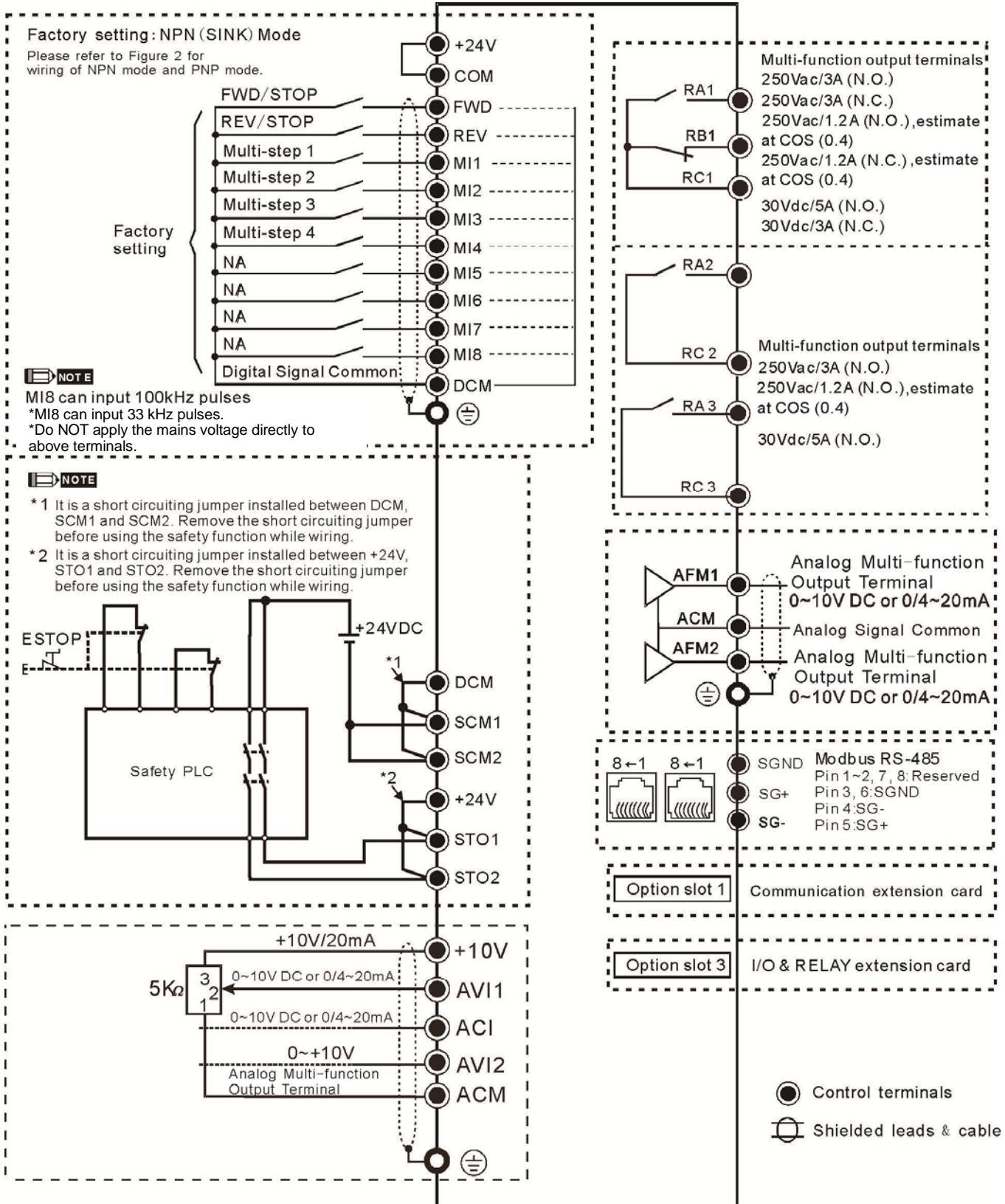

SINK (NPN) /SOURCE (PNP) Mode

① Sink Mode with internal power (+24VDC)

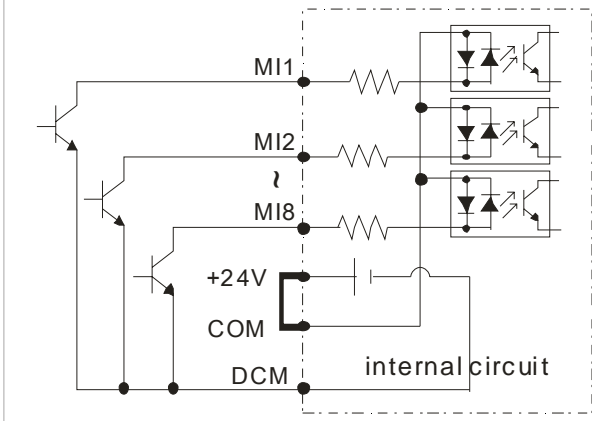

② Source Mode with internal power (+24VDC)

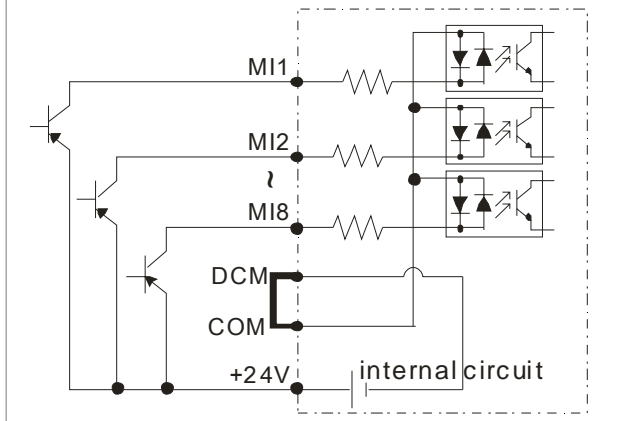

③ Sink Mode with external power

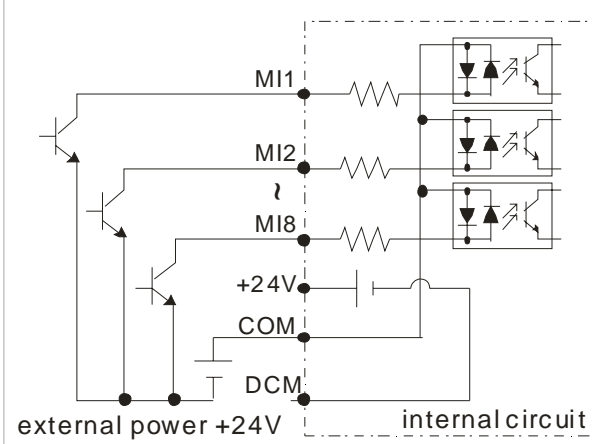

④ Source Mode with external power

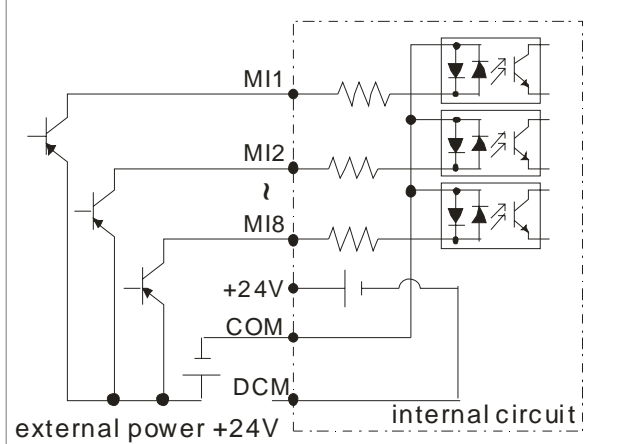

4-2 System Wiring Diagram

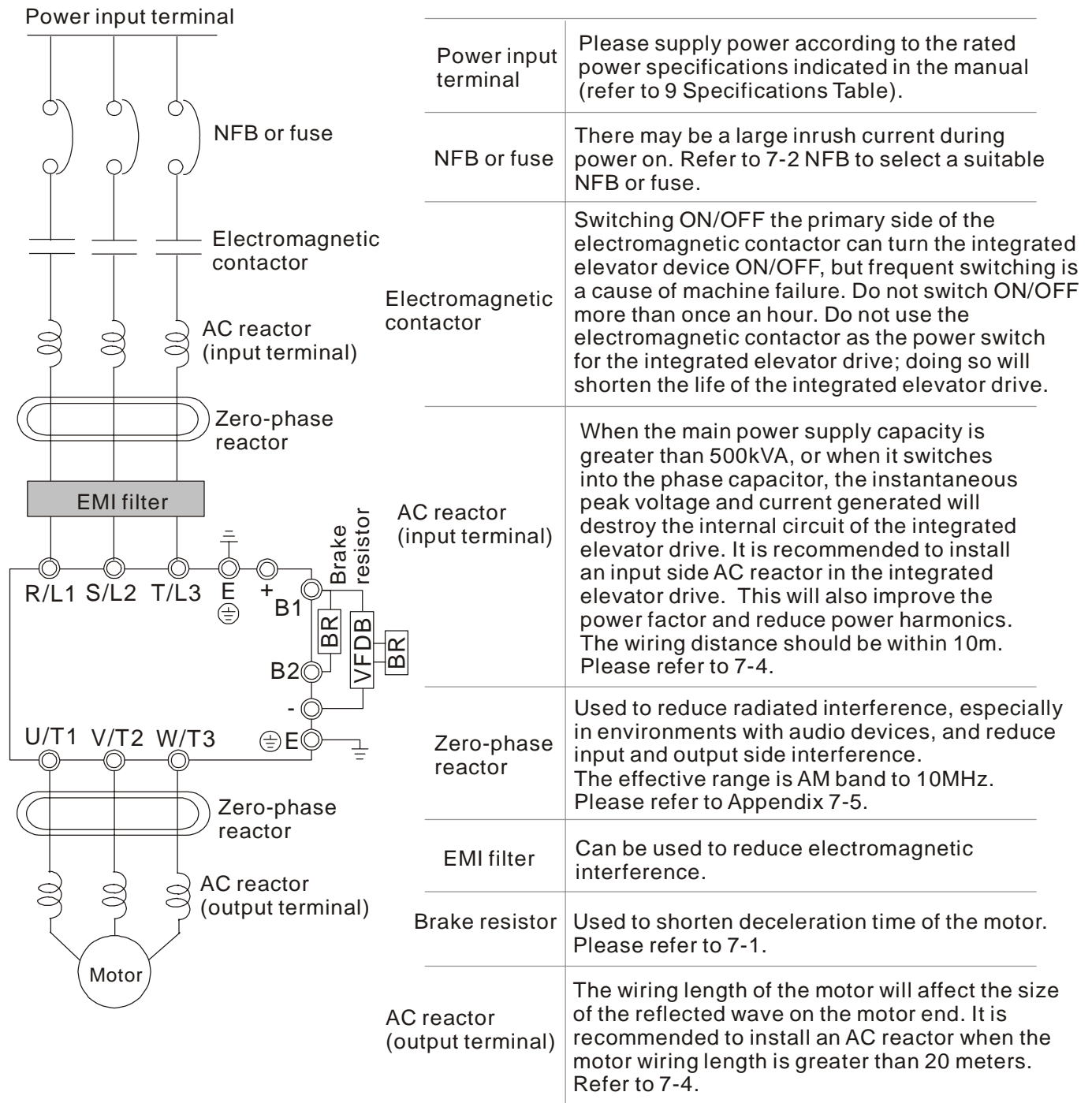

4-3 Wiring Plate Diagram

Frame A

Screw torque:
 1~4: 14~16kg-cm
 5: 6~8kg-cm

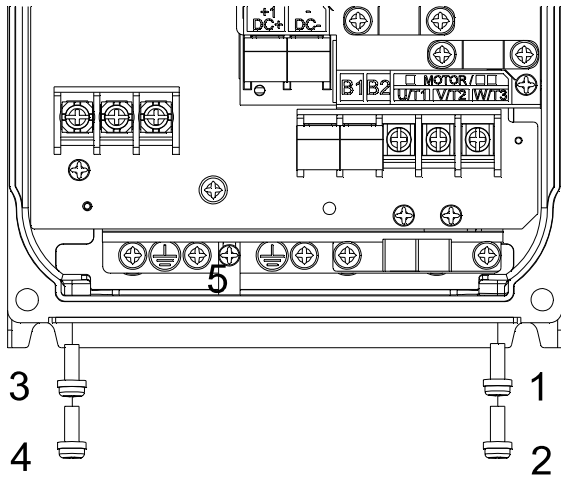

Frame B

Screw torque:
 1~4: 14~16kg-cm
 5: 6~8kg-cm

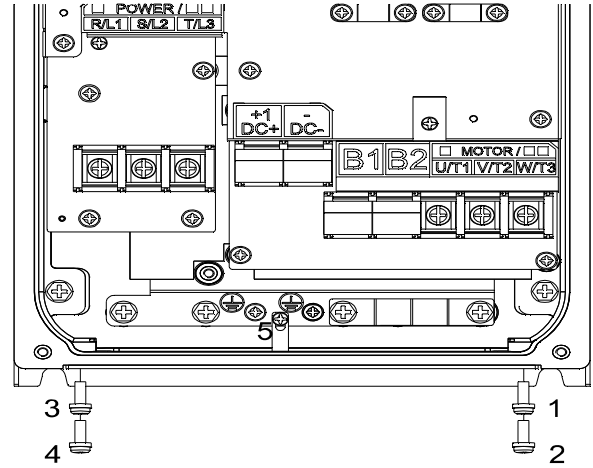

Frame C

Screw torque:
 1~6: 12~15kg-cm
 7~8: 12~15kg-cm

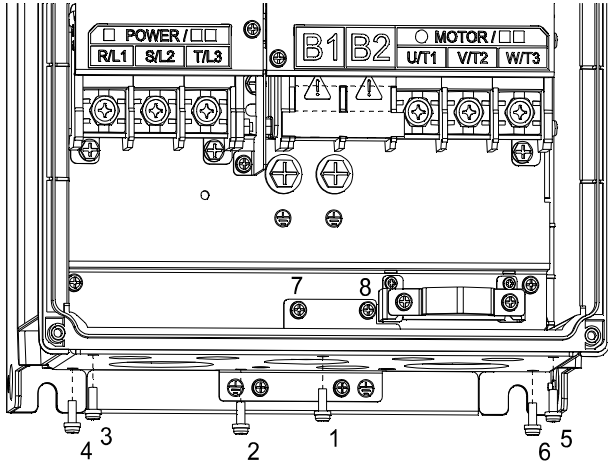

4-4 Basic Waterproof Component Wiring Diagram

Frame A

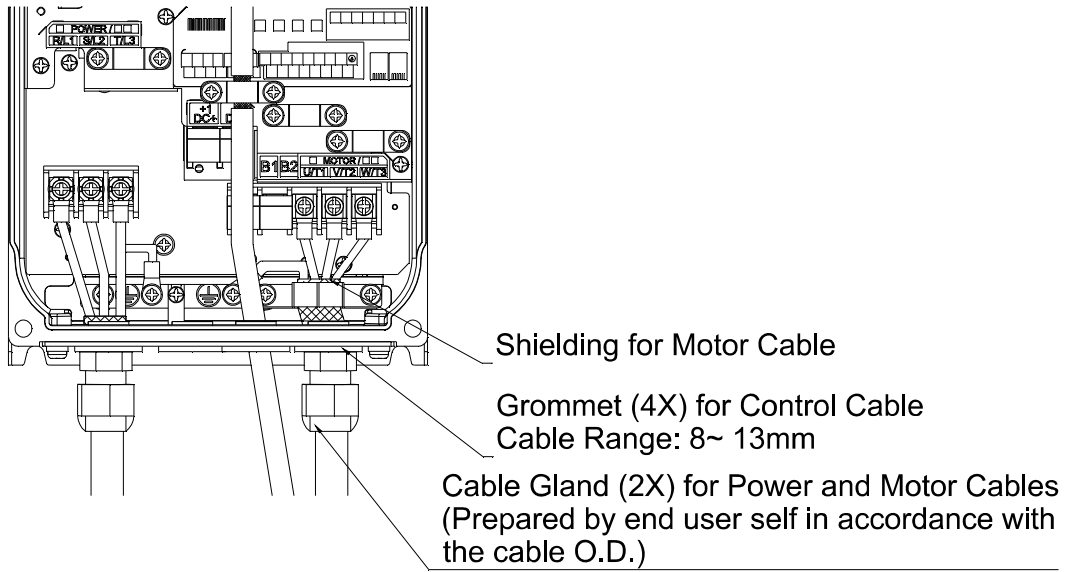

Frame B

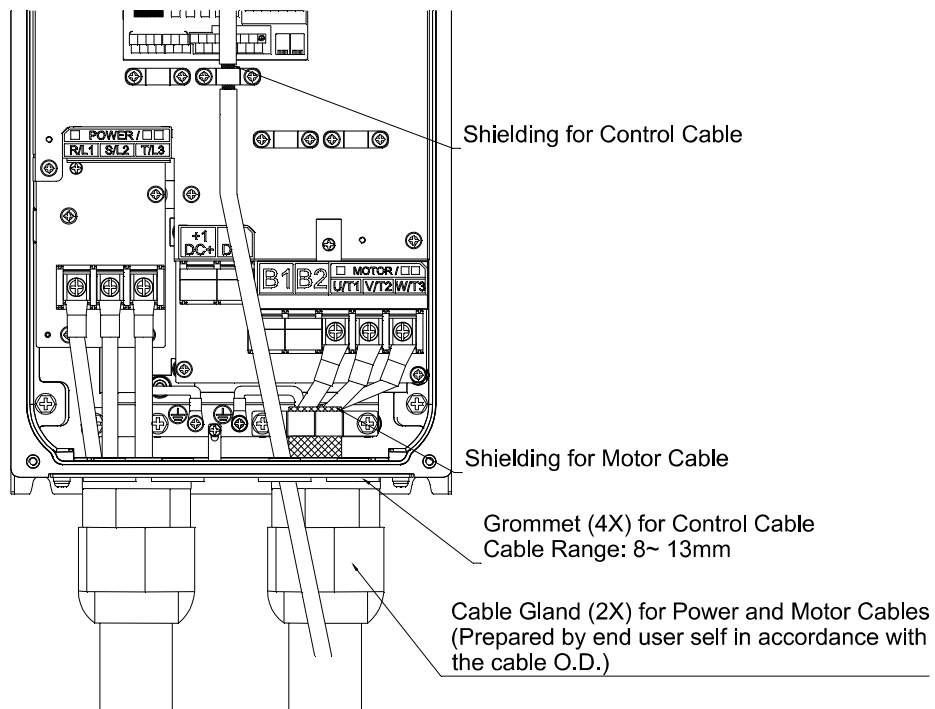

Frame C/D0

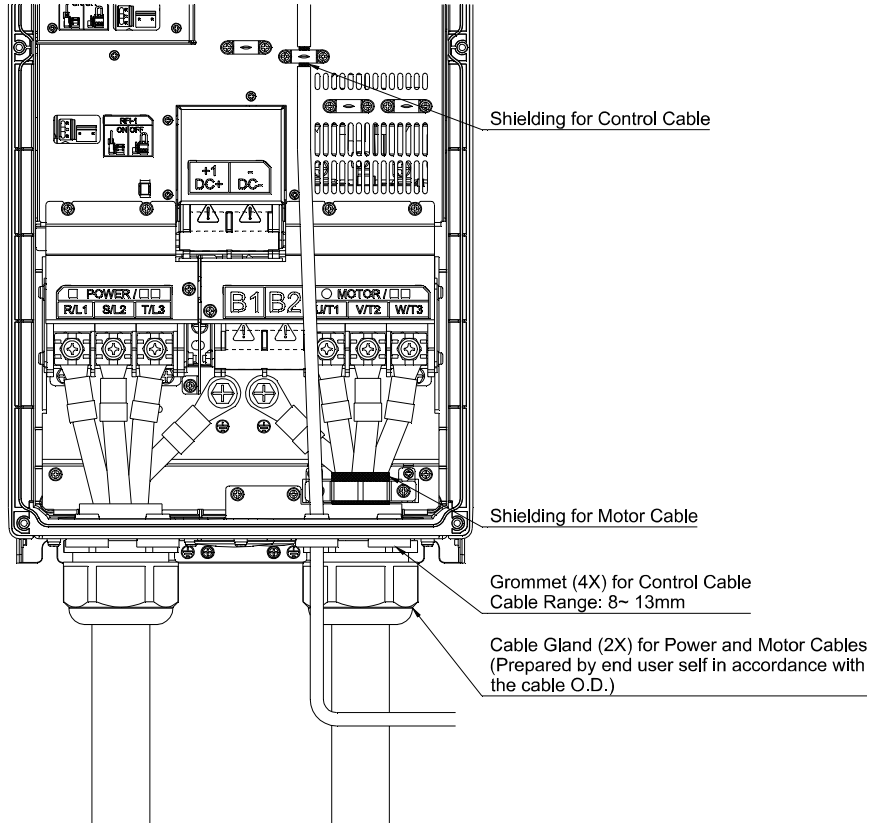

Frame D

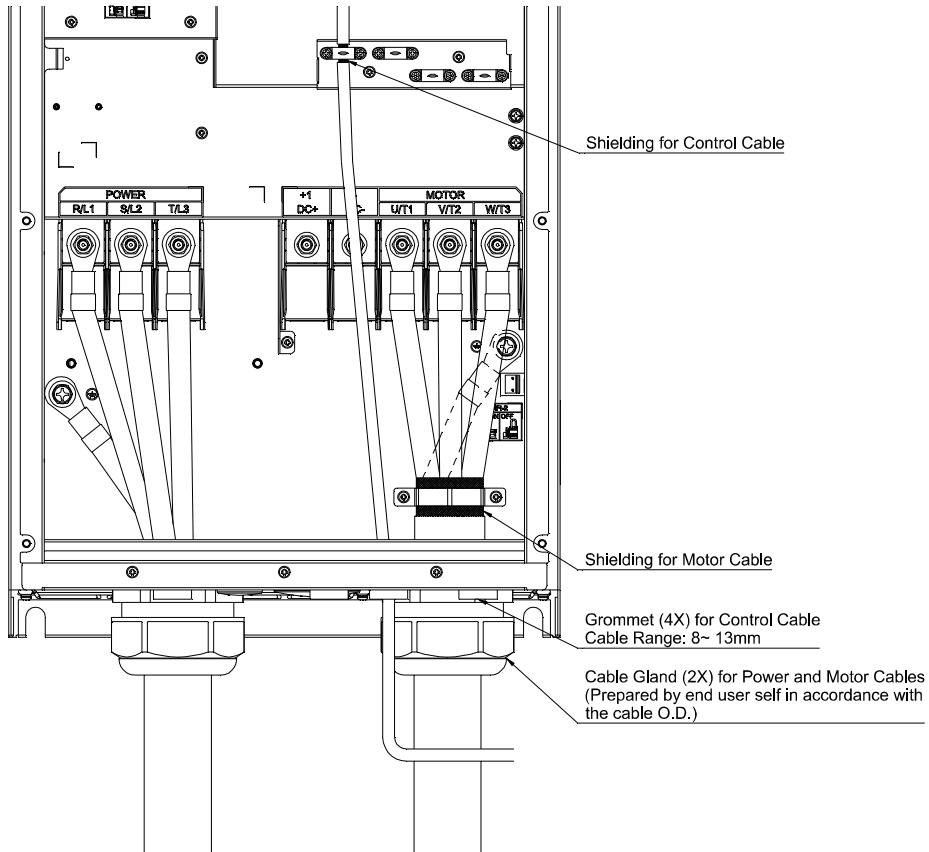

Chapter 5 Main Circuit Terminals



Main power terminals

- ☑ Do not connect 3-phase model to one-phase power. R/L1, S/L2 and T/L3 has no phase-sequence requirement, it can be used upon random selection.
- ☑ It is recommend adding a magnetic contactor (MC) to the power input wiring to cut off power quickly and reduce malfunction when activating the protection function of the AC motor drive. Both ends of the MC should have an R-C surge absorber.
- ☑ Please use voltage and current within the specification.
- ☑ When using a general GFCI (Ground Fault Circuit Interrupter), select a current sensor with sensitivity of 200mA or above and not less than 0.1-second operation time to avoid nuisance tripping.
- ☑ Please use the shield wire or tube for the power wiring and ground the two ends of the shield wire or tube.
- ☑ Do NOT run/stop AC motor drives by turning the power ON/OFF. Run/stop AC motor drives by RUN/STOP command via control terminals or keypad. If you still need to run/stop AC motor drives by turning power ON/OFF, it is recommended to do so only ONCE per hour.

Output terminals for main circuit

- ☑ When it needs to install the filter at the output side of terminals U/T1, V/T2, W/T3 on the AC motor drive. Please use inductance filter. Do not use phase-compensation capacitors or L-C (Inductance-Capacitance) or R-C (Resistance-Capacitance), unless approved by Delta.
- ☑ Use well-insulated motor, suitable for inverter operation.
- ☑ Note down the rated data and the torque force of the wiring when the output terminal is below 75°C. This information provides the right wiring method to wire terminals (It corresponds to the terminals of the motor wire and non-motor wire).
- ☑ When the AC drive output terminals U/T1, V/T2, and W/T3 are connected to the motor terminals U/T1, V/T2, and W/T3, respectively, the motor will rotate counterclockwise (as viewed on the shaft end of the motor) when a forward operation command is received. To permanently reverse the direction of motor rotation, switch over any of the two motor leads

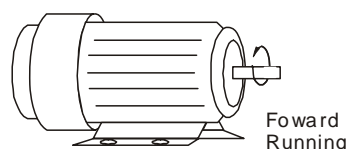

Terminals for connecting DC reactor, external brake resistor, external brake resistor and DC circuit

- ☑ Connect a brake resistor or brake unit in applications with frequent deceleration ramps, short deceleration time, too low brake torque or requiring increased brake torque.

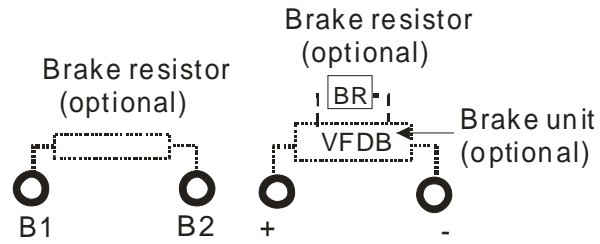

- ☑ The external brake resistor of Frame A, B and C should connect to the terminals (B1, B2) of AC motor drives.
- ☑ For those models without built-in brake resistor, please connect external brake unit and brake resistor (both of them are optional) to increase brake torque.
- ☑ When the terminals +1/DC+, -/DC- are not used, please leave the terminals open.
- ☑ DC+ and DC- are connected by common DC bus, please refer to Chapter 5-1(Main Circuit Terminal) for the wiring terminal specification and the wire gauge information.
- ☑ Please refer to the VFDB manual for more information on wire gauge when installing the brake unit.

5-1 Main Circuit Diagram

For frame A~C

* Provide 3-phase input power

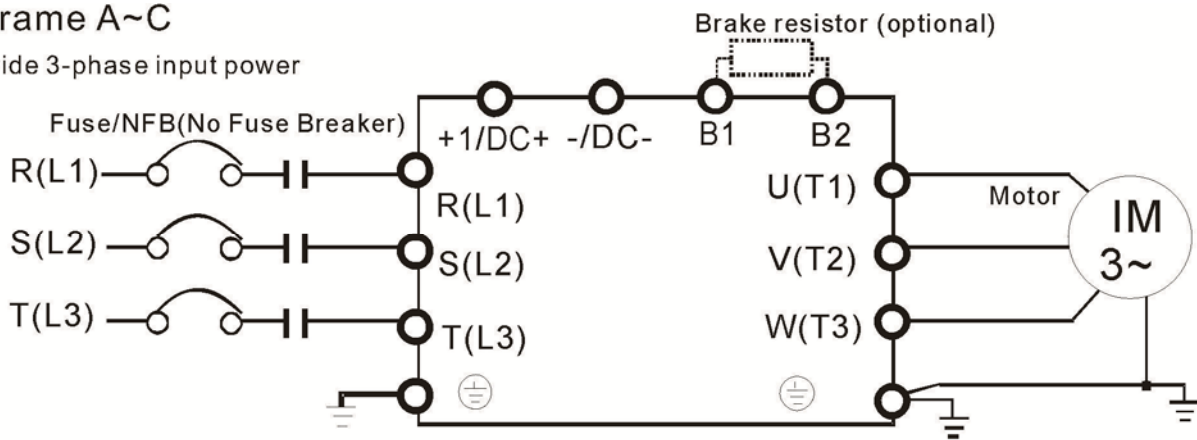

For frame D0~D

* Provide 3-phase input power

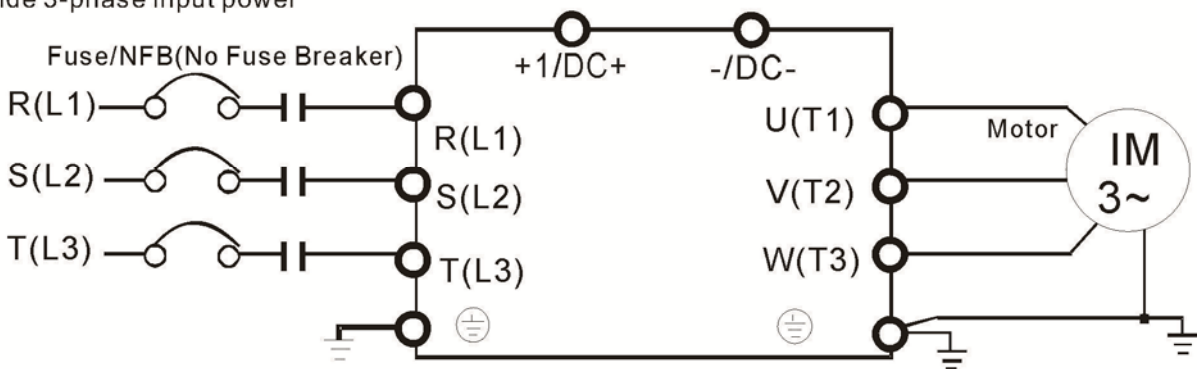

Terminals	Descriptions
R/L1, S/L2, T/L3	AC line input terminals 3-phase
U/T1, V/T2, W/T3	AC drive output terminals for connecting 3-phase induction motor
+1/DC+, -/DC-	Connections for brake unit (VFDB series) ($\leq 30\text{kW}$, built-in brake unit) Common DC Bus
B1, B2	Connections for brake resistor (optional)
⊕	Earth connection, please comply with local regulations.

5-2 Main Circuit Terminals

Frame A

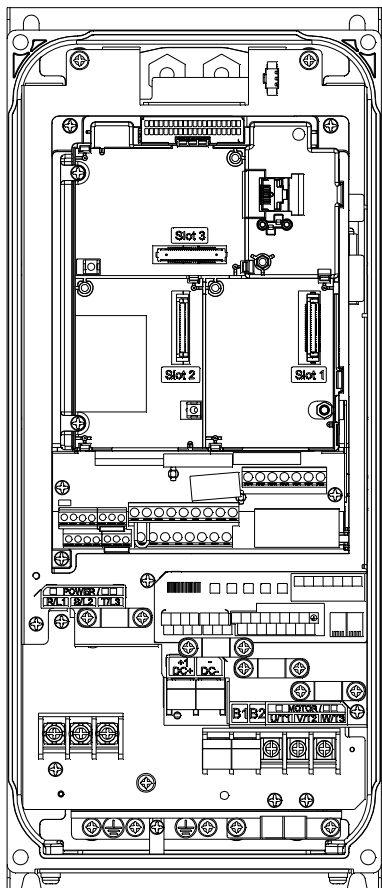

Main circuit terminals:

- If you install at Ta 40°C above environment, please select copper wire which have voltage rating 600V and temperature resistant 90°C or above.
- If you install at Ta 40°C environment, please select copper wire which have voltage rating 600V and temperature resistant 75°C or 90°C.
- For UL installation compliant, you have to use copper wires when installation, the wire gauge is based on temperature resistant 75°C which is according to the requirements and recommendations from UL. Do not reduce the wire gauge when using higher temperature wire.

R/L1, S/L2, T/L3, U/T1, V/T2, W/T3, B1, B2,

Models	Max. Wire Gauge	Min. Wire Gauge	Torque
VFD007FP4EA-41/52	10 AWG [5.3mm ²]	12 AWG [3.3mm ²]	M3.5
VFD015FP4EA-41/52			10kg-cm [8.7 lb-in.] [0.98Nm]
VFD022FP4EA-41/52			
VFD037FP4EA-41/52		10AWG [5.3mm ²]	M4.0
VFD040FP4EA-41/52			18kg-cm [15.6 lb-in.] [1.77Nm]
VFD055FP4EA-41/52			
VFD075FP4EA-41/52			

⊕ · DC- · DC+

Models	Max. Wire Gauge	Min. Wire Gauge	Torque	
VFD007FP4EA-41/52	10 AWG [5.3mm ²]	12 AWG [3.3mm ²]	M4.0 18kg-cm [15.6 lb-in.] [1.77Nm]	
VFD015FP4EA-41/52				
VFD022FP4EA-41/52				
VFD037FP4EA-41/52		10AWG [5.3mm ²]		
VFD040FP4EA-41/52				
VFD055FP4EA-41/52				
VFD075FP4EA-41/52				

- ☑ It needs following additional terminal when wiring. The additional terminal dimension should comply with the following figure 1.
- ☑ After crimping the wire to the ring lug (must UL approved), UL and CSA approved R/C(YDPU2) heat shrink tubing rated min 600Vac insulation shall be install over the live part.

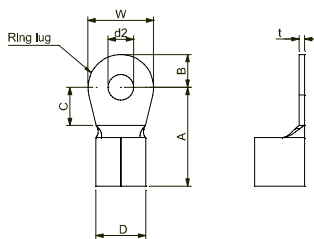

Figure 1.

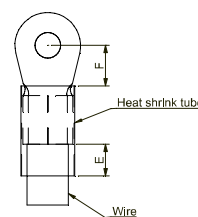
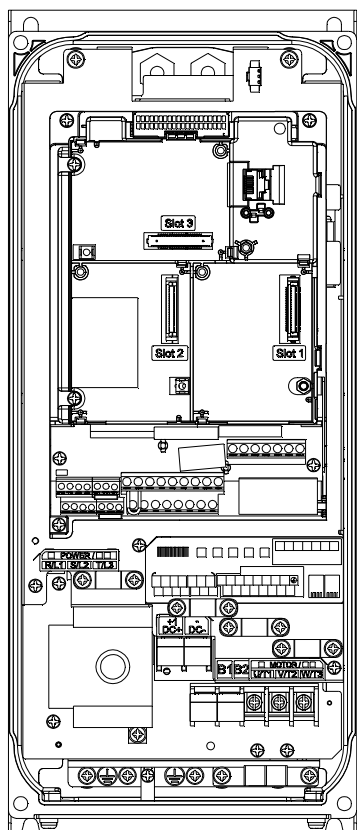

Figure 2.

A (MAX)	B (MAX)	C (min)	D (MAX)	d2 (min)	E (min)	F (min)	W (MAX)	T (MAX)
12.1	3.6	6.1	5.6	4.3	7.0	6.1	7.3	1.0

Unit: mm

Frame A



Main circuit terminals:

- If you install at Ta 40°C above environment, please select copper wire which have voltage rating 600V and temperature resistant 90°C or above.
- If you install at Ta 40°C environment, please select copper wire which have voltage rating 600V and temperature resistant 75°C or 90°C.
- For UL installation compliant, you have to use copper wires when installation, the wire gauge is based on temperature resistant 75°C which is according to the requirements and recommendations from UL. Do not reduce the wire gauge when using higher temperature wire.

R/L1, S/L2, T/L3,

Models	Max. Wire Gauge	Min. Wire Gauge	Torque
VFD007FP4EA-52S	10 AWG [5.3mm ²]	12 AWG [3.3mm ²]	8kg-cm [6.9lb-in.] [0.78Nm]
VFD015FP4EA-52S			
VFD022FP4EA-52S			
VFD037FP4EA-52S		10AWG [5.3mm ²]	
VFD040FP4EA-52S			
VFD055FP4EA-52S			
VFD075FP4EA-52S			

U/T1, V/T2, W/T3, B1, B2,

Models	Max. Wire Gauge	Min. Wire Gauge	Torque
VFD007FP4EA-52S	10 AWG [5.3mm ²]	12 AWG [3.3mm ²]	M3.5 10kg-cm [8.7 lb-in.] [0.98Nm]
VFD015FP4EA-52S			
VFD022FP4EA-52S			
VFD037FP4EA-52S		10AWG [5.3mm ²]	M4.0 18kg-cm [15.6 lb-in.] [1.77Nm]
VFD040FP4EA-52S			
VFD055FP4EA-52S			
VFD075FP4EA-52S			

⊕ · DC- · DC+

Models	Max. Wire Gauge	Min. Wire Gauge	Torque
VFD007FP4EA-52S	10 AWG [5.3mm ²]	12 AWG [3.3mm ²]	M4.0 18kg-cm [15.6 lb-in.] [1.77Nm]
VFD015FP4EA-52S			
VFD022FP4EA-52S			
VFD037FP4EA-52S		10AWG [5.3mm ²]	
VFD040FP4EA-52S			
VFD055FP4EA-52S			
VFD075FP4EA-52S			

- ☑ It needs following additional terminal when wiring. The additional terminal dimension should comply with the following figure 1.
- ☑ After crimping the wire to the ring lug (must UL approved), UL and CSA approved R/C(YDPU2) heat shrink tubing rated min 600Vac insulation shall be install over the live part.

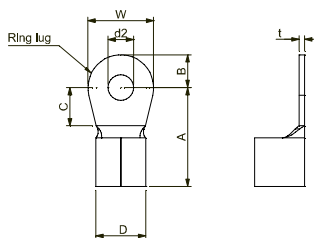

Figure 1.

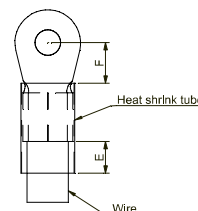
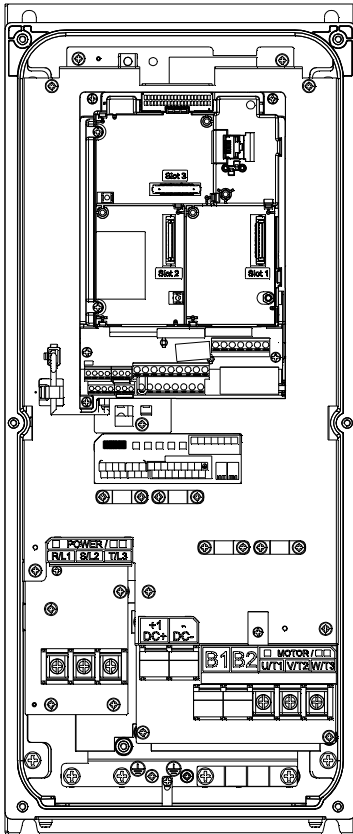

Figure 2.

A (MAX)	B (MAX)	C (min)	D (MAX)	d2 (min)	E (min)	F (min)	W (MAX)	T (MAX)
12.1	3.6	6.1	5.6	4.3	7.0	6.1	7.3	1.0

Unit: mm

Frame B



Main circuit terminals:

- If you install at Ta 40°C above environment, please select copper wire which have voltage rating 600V and temperature resistant 90°C or above.
- If you install at Ta 40°C environment, please select copper wire which have voltage rating 600V and temperature resistant 75°C or 90°C.
- For UL installation compliant, you have to use copper wires when installation, the wire gauge is based on temperature resistant 75°C which is according to the requirements and recommendations from UL. Do not reduce the wire gauge when using higher temperature wire.

R/L1, S/L2, T/L3, U/T1, V/T2, W/T3, ⊕, B1, B2, DC-,DC+

Models	Max. Wire Gauge	Min. Wire Gauge	Torque	
VFD110FP4EA-41/52	6 AWG [13.3mm ²]	8 AWG [8.4mm ²]	M5 25kg-cm [21.7 lb-in.] [2.45Nm]	
VFD150FP4EA-41/52		6 AWG [13.3mm ²]		
VFD185FP4EA-41/52				6 AWG [13.3mm ²]
VFD220FP4EA-41/52				

- ☑ It needs following additional terminal when wiring. The additional terminal dimension should comply with the following figure 1.
- ☑ After crimping the wire to the ring lug (must UL approved), UL and CSA approved R/C(YDPU2) heat shrink tubing rated min 600Vac insulation shall be install over the live part.

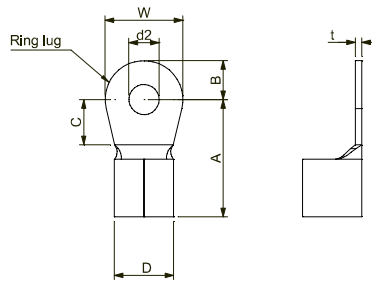

Figure 1.

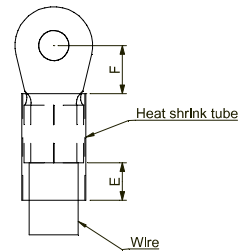
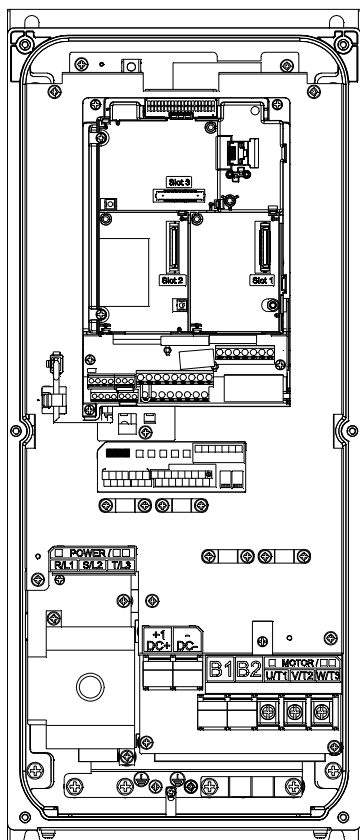

Figure 2.

A (MAX)	B (MAX)	C (min)	D (MAX)	d2 (min)	E (min)	F (min)	W (MAX)	T (MAX)
23.8	6.0	13.3	9.0	5.3	11.0	13.3	12.0	1.5

Unit: mm

Frame B



Main circuit terminals:

- If you install at Ta 40°C above environment, please select copper wire which have voltage rating 600V and temperature resistant 90°C or above.
- If you install at Ta 40°C environment, please select copper wire which have voltage rating 600V and temperature resistant 75°C or 90°C.
- For UL installation compliant, you have to use copper wires when installation, the wire gauge is based on temperature resistant 75°C which is according to the requirements and recommendations from UL. Do not reduce the wire gauge when using higher temperature wire.

R/L1, S/L2, T/L3,

Models	Max. Wire Gauge	Min. Wire Gauge	Torque
VFD110FP4EA-52S	6 AWG [13.3mm ²]	8 AWG [8.4mm ²]	21kg-cm [18.2lb-in.] [2.06Nm]
VFD150FP4EA-52S		6 AWG [13.3mm ²]	
VFD185FP4EA-52S			6 AWG [13.3mm ²]
VFD220FP4EA-52S			

U/T1, V/T2, W/T3, B1, B2, ⊕ · DC- · DC+

Models	Max. Wire Gauge	Min. Wire Gauge	Torque	
VFD110FP4EA-52S	6 AWG [13.3mm ²]	8 AWG [8.4mm ²]	M5.0	
VFD150FP4EA-52S		6 AWG [13.3mm ²]	6 AWG [13.3mm ²]	25kg-cm [21.7lb-in.] [2.45Nm]
VFD185FP4EA-52S				
VFD220FP4EA-52S				

- ☑ It needs following additional terminal when wiring. The additional terminal dimension should comply with the following figure 1.
- ☑ After crimping the wire to the ring lug (must UL approved), UL and CSA approved R/C(YDPU2) heat shrink tubing rated min 600Vac insulation shall be install over the live part.

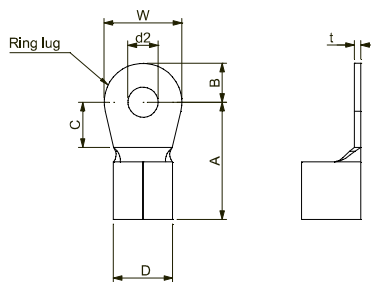

Figure 1.

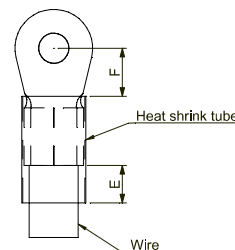
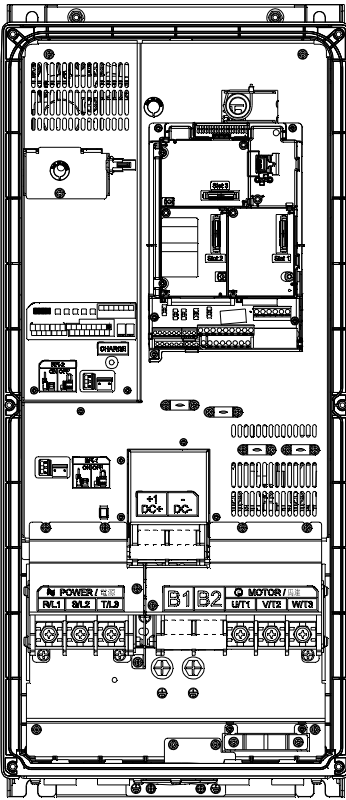

Figure 2.

A (MAX)	B (MAX)	C (min)	D (MAX)	d2 (min)	E (min)	F (min)	W (MAX)	T (MAX)
23.8	6.0	13.3	9.0	5.3	11.0	13.3	12.0	1.5

Unit: mm

Frame C



Main circuit terminals:

- If you install at Ta 40°C above environment, please select copper wire which have voltage rating 600V and temperature resistant 90°C or above.
- If you install at Ta 40°C environment, please select copper wire which have voltage rating 600V and temperature resistant 75°C or 90°C.
- For UL installation compliant, you have to use copper wires when installation, the wire gauge is based on temperature resistant 75°C which is according to the requirements and recommendations from UL. Do not reduce the wire gauge when using higher temperature wire.

R/L1, S/L2, T/L3, U/T1, V/T2, W/T3, ⊕, B1, B2, -DC-, +1/DC+

Models	Max. Wire Gauge	Min. Wire Gauge	Torque
VFD300FP4EA-41/52	2 AWG [33.6mm ²]	4 AWG [21.2mm ²]	M8 81.6kg-cm [70.8 lb-in.]
VFD370FP4EA-41/52		2 AWG [33.6mm ²]	[8.00Nm]

UL installations must use 600V, 90°C wire. Use copper wire only.

- ☑ It needs following additional terminal when wiring. The additional terminal dimension should comply with the following figure 1.
- ☑ After crimping the wire to the ring lug (must UL approved), UL and CSA approved R/C(YDPU2) heat shrink tubing rated min 600Vac insulation shall be install over the live part.

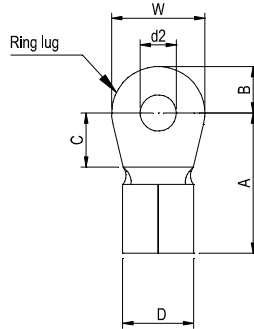

Figure 1

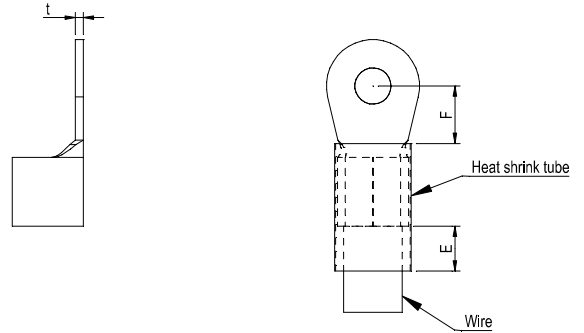
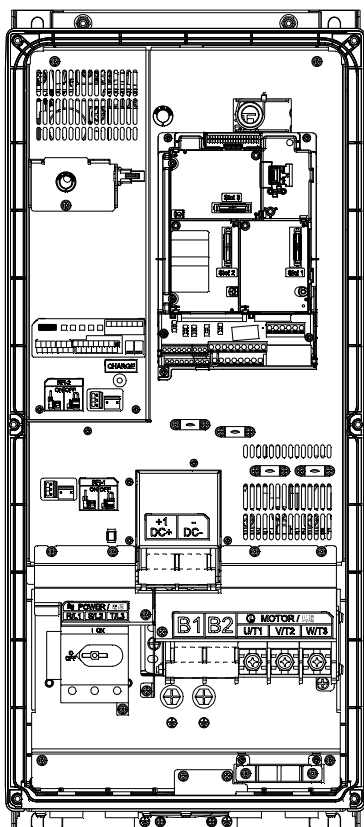

Figure 2

Unit: mm

A (MAX)	B (MAX)	C (min)	D (MAX)	d2 (min)	E (min)	F (min)	W (MAX)	T (MAX)
40	10	10	15	8.3	13	12	22	2.5

Frame C



Main circuit terminals:

- If you install at Ta 40°C above environment, please select copper wire which have voltage rating 600V and temperature resistant 90°C or above.
- If you install at Ta 40°C environment, please select copper wire which have voltage rating 600V and temperature resistant 75°C or 90°C.
- For UL installation compliant, you have to use copper wires when installation, the wire gauge is based on temperature resistant 75°C which is according to the requirements and recommendations from UL. Do not reduce the wire gauge when using higher temperature wire.

R/L1, S/L2, T/L3, (Stranded wire only)

Models	Max. Wire Gauge	Min. Wire Gauge	Torque
VFD300FP4EA-52S	2 AWG [33.6mm ²]	4 AWG [21.2mm ²]	21kg-cm [18.2lb-in.] [2.06Nm]
VFD370FP4EA-52S		2 AWG [33.6mm ²]	

U/T1, V/T2, W/T3, ⊕, B1, B2, -/DC-, +1/DC+

Models	Max. Wire Gauge	Min. Wire Gauge	Torque
VFD300FP4EA-52S	2 AWG [33.6mm ²]	4 AWG [21.2mm ²]	M8 81.6kg-cm [70.8 lb-in.] [8.00Nm]
VFD370FP4EA-52S		2 AWG [33.6mm ²]	

- ☑ It needs following additional terminal when wiring. The additional terminal dimension should comply with the following figure 1.
- ☑ After crimping the wire to the ring lug (must UL approved), UL and CSA approved R/C(YDPU2) heat shrink tubing rated min 600Vac insulation shall be install over the live part.

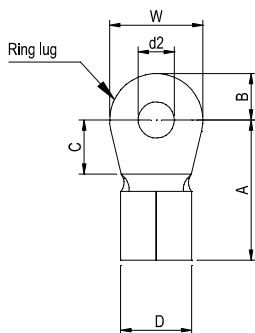

Figure 1

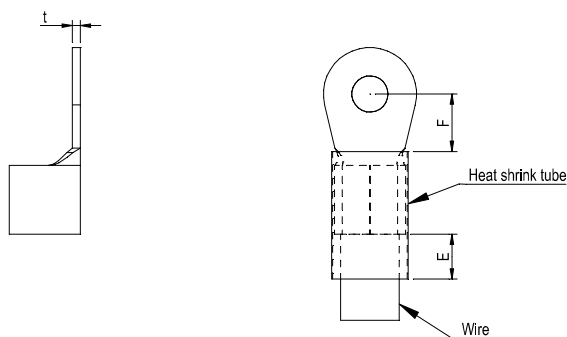
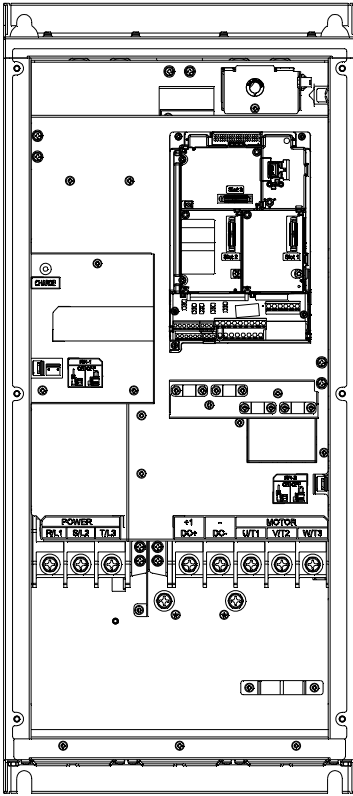

Figure 2

Unit: mm

A (MAX)	B (MAX)	C (min)	D (MAX)	d2 (min)	E (min)	F (min)	W (MAX)	T (MAX)
40	10	10	15	8.3	13	12	22	2.5

Frame D0



Main circuit terminals:

- If you install at Ta 35°C above environment, please select copper wire which have voltage rating 600V and temperature resistant 90°C or above.
- If you install at Ta 35°C environment, please select copper wire which have voltage rating 600V and temperature resistant 75°C or 90°C.
- For UL installation compliant, you have to use copper wires when installation, the wire gauge is based on temperature resistant 75°C which is according to the requirements and recommendations from UL. Do not reduce the wire gauge when using higher temperature wire.

R/L1, S/L2, T/L3, U/T1, V/T2, W/T3, ⊕, -/DC-, +1/DC+

Models	Max. Wire Gauge	Min. Wire Gauge	Torque
VFD450FP4EA-41/52	1/0 AWG [53.5mm ²]	1 AWG [42.4mm ²]	M8 81.6kg-cm [70.8 lb-in.]
VFD550FP4EA-41/52		1/0 AWG [53.5mm ²]	[8.00Nm]

- ☑ It needs following additional terminal when wiring. The additional terminal dimension should comply with the following figure 1.
- ☑ After crimping the wire to the ring lug (must UL approved), UL and CSA approved R/C(YDPU2) heat shrink tubing rated min 600Vac insulation shall be install over the live part.

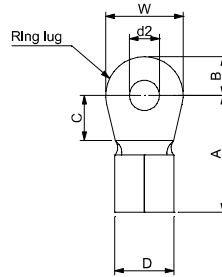

Figure 1.

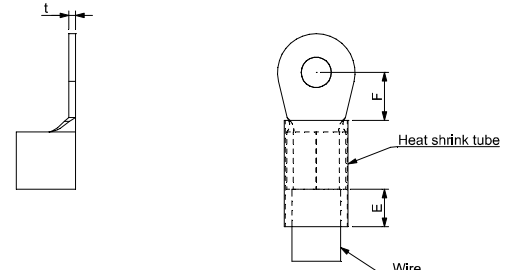
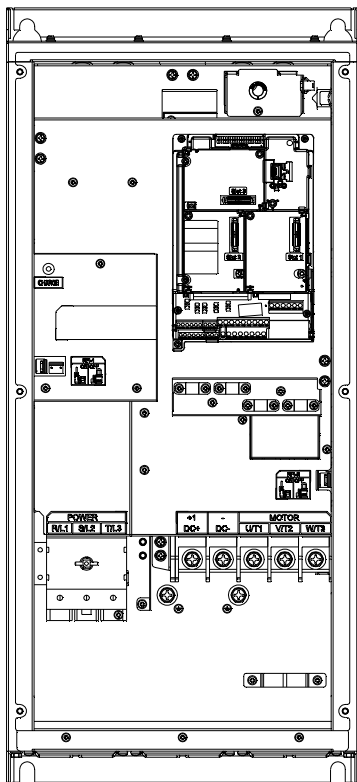

Figure 2.

Unit: mm

A (MAX)	B (MAX)	C (min)	D (MAX)	d2 (min)	E (min)	F (min)	W (MAX)	t (MAX)
39	10.5	10	20	8.3	13	11.5	22	2.5

Frame D0



Main circuit terminals:

- If you install at Ta 35°C above environment, please select copper wire which have voltage rating 600V and temperature resistant 90°C or above.
- If you install at Ta 35°C environment, please select copper wire which have voltage rating 600V and temperature resistant 75°C or 90°C.
- For UL installation compliant, you have to use copper wires when installation, the wire gauge is based on temperature resistant 75°C which is according to the requirements and recommendations from UL. Do not reduce the wire gauge when using higher temperature wire.

R/L1, S/L2, T/L3, (Stranded wire only)

Models	Max. Wire Gauge	Min. Wire Gauge	Torque
VFD450FP4EA-52S	1/0 AWG [53.5mm ²]	1 AWG [42.4mm ²]	63.3kg-cm [55lb-in.] [6.20Nm]
VFD550FP4EA-52S		1/0 AWG [53.5mm ²]	

U/T1, V/T2, W/T3, ⊕, -/DC-, +1/DC+

Models	Max. Wire Gauge	Min. Wire Gauge	Torque
VFD450FP4EA-52S	1/0 AWG [53.5mm ²]	1 AWG [42.4mm ²]	M8 81.6kg-cm [70.8 lb-in.] [8.00Nm]
VFD550FP4EA-52S		1/0 AWG [53.5mm ²]	

- ☑ It needs following additional terminal when wiring. The additional terminal dimension should comply with the following figure 1.
- ☑ After crimping the wire to the ring lug (must UL approved), UL and CSA approved R/C(YDPU2) heat shrink tubing rated min 600Vac insulation shall be install over the live part.

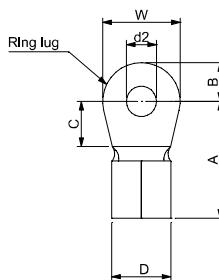

Figure 1.

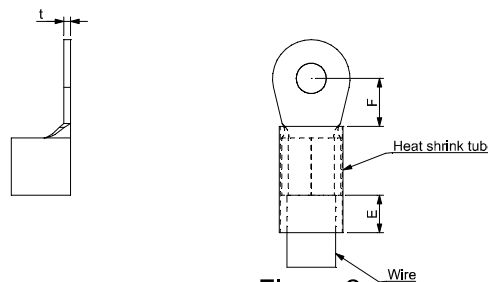
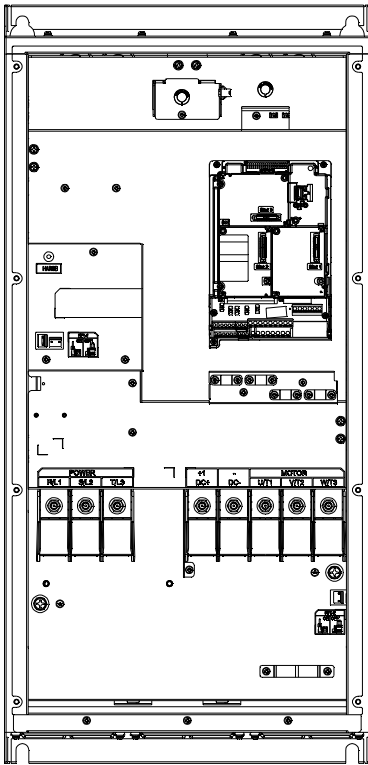

Figure 2.

Unit: mm

A (MAX)	B (MAX)	C (min)	D (MAX)	d2 (min)	E (min)	F (min)	W (MAX)	t (MAX)
39	10.5	10	20	8.3	13	11.5	22	2.5

Frame D



Main circuit terminals:

- If you install at Ta 30°C above environment, please select copper wire which have voltage rating 600V and temperature resistant 90°C or above.
- If you install at Ta 30°C environment, please select copper wire which have voltage rating 600V and temperature resistant 75°C or 90°C.
- For UL installation compliant, you have to use copper wires when installation, the wire gauge is based on temperature resistant 75°C which is according to the requirements and recommendations from UL. Do not reduce the wire gauge when using higher temperature wire.

R/L1, S/L2, T/L3, U/T1, V/T2, W/T3, ⊕, -DC-, +1/DC+

Models	Max. Wire Gauge	Min. Wire Gauge	Torque
VFD750FP4EA-41/52	4/0 AWG [107mm ²]	3/0AWG [85mm ²]	M8 200kg-cm [173 lb-in.]
VFD900FP4EA-41/52		4/0AWG [107mm ²]	[19.62Nm]

- ☑ It needs following additional terminal when wiring. The additional terminal dimension should comply with the following figure 1.
- ☑ After crimping the wire to the ring lug (must UL approved), UL and CSA approved R/C(YDPU2) heat shrink tubing rated min 600Vac insulation shall be install over the live part.

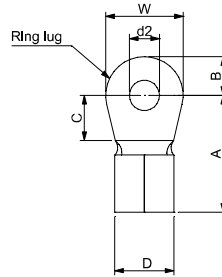

Figure 1.

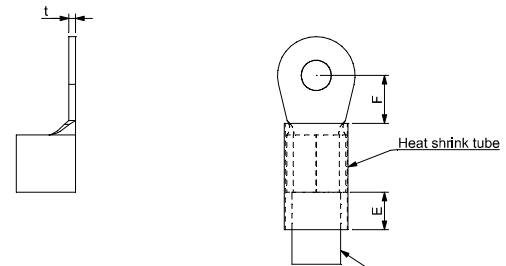
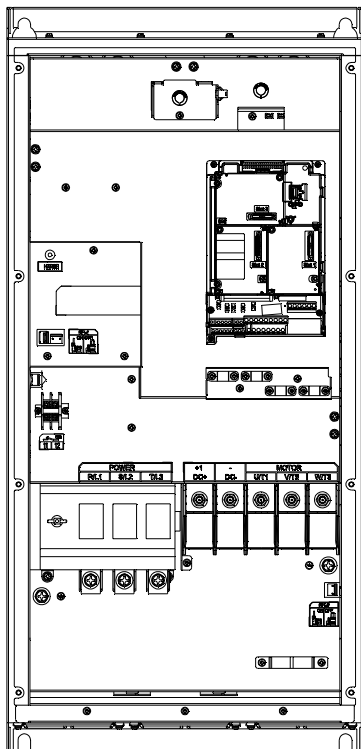

Figure 2.

Unit: mm

A (MAX)	B (MAX)	C (min)	D (MAX)	d2 (min)	E (min)	F (min)	W (MAX)	t (MAX)
42	12	10	23	8.3	13	14	23	3.5

Frame D



Main circuit terminals:

- If you install at Ta 30°C above environment, please select copper wire which have voltage rating 600V and temperature resistant 90°C or above.
- If you install at Ta 30°C environment, please select copper wire which have voltage rating 600V and temperature resistant 75°C or 90°C.
- For UL installation compliant, you have to use copper wires when installation, the wire gauge is based on temperature resistant 75°C which is according to the requirements and recommendations from UL. Do not reduce the wire gauge when using higher temperature wire.

R/L1, S/L2, T/L3,

Models	Max. Wire Gauge	Min. Wire Gauge	Torque
VFD750FP4EA-52S	4/0 AWG [107mm ²]	3/0AWG [85mm ²]	M8 200kg-cm [173 lb-in.] [19.62Nm]
VFD900FP4EA-52S		4/0AWG [107mm ²]	

U/T1, V/T2, W/T3, ⊕, -/DC-, +1/DC+

Models	Max. Wire Gauge	Min. Wire Gauge	Torque
VFD750FP4EA-52S	4/0 AWG [107mm ²]	3/0AWG [85mm ²]	M8 200kg-cm [173 lb-in.] [19.62Nm]
VFD900FP4EA-52S		4/0AWG [107mm ²]	

- ☑ It needs following additional terminal when wiring. The additional terminal dimension should comply with the following figure 1.
- ☑ After crimping the wire to the ring lug (must UL approved), UL and CSA approved R/C(YDPU2) heat shrink tubing rated min 600Vac insulation shall be install over the live part.

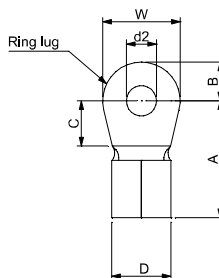

Figure 1.

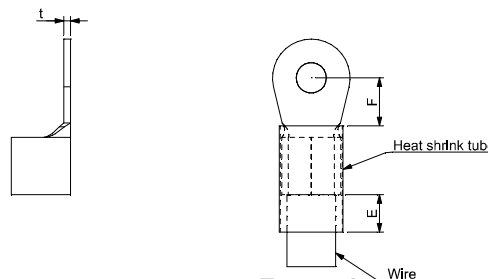

Figure 2.

Unit: mm

A (MAX)	B (MAX)	C (min)	D (MAX)	d2 (min)	E (min)	F (min)	W (MAX)	t (MAX)
42	12	10	23	8.3	13	14	23	3.5

[The page intentionally left blank]

Chapter 6 Control Terminals

6-1 Remove the cover for wiring

Please remove the top cover before wiring the multi-function input and output terminals,

The drive appearances shown in the figures are for reference only, a real drive may look different.

Remove the cover for wiring. Frame A~D

Frame A&B

Screw torque: 12~15Kg-cm [10.4~13lb-in.]

- 1) Remove the keypad. (As shown in figure 2)
- 2) Loosen the screws and press the tabs on both sides to remove the cover. (As shown in figure 3)

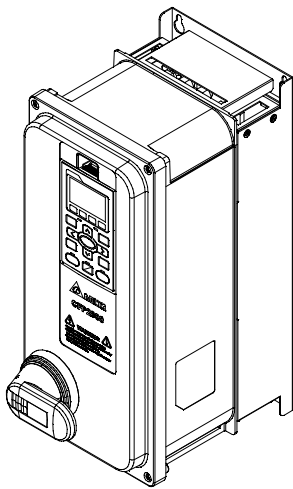

Figure 1

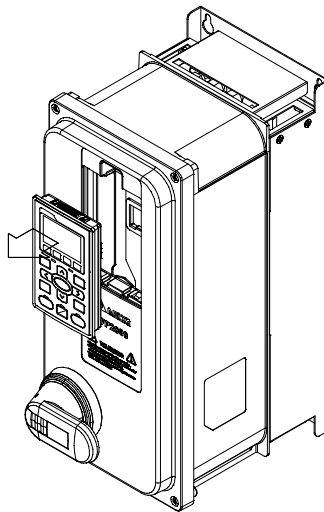

Figure 2

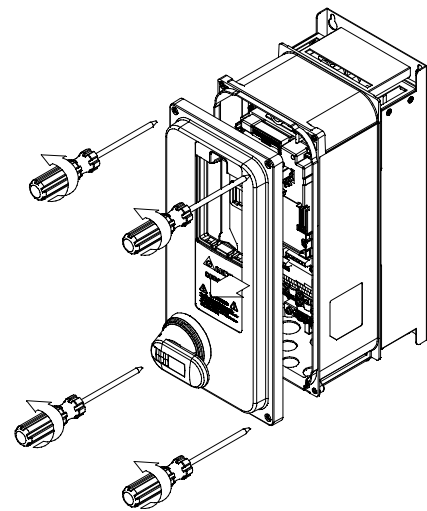

Figure 3

Frame C

Screw torque: 12~15Kg-cm [10.4~13lb-in.]

- 1) Remove the keypad. (As shown in figure 2)
- 2) Loosen the screws and press the tabs on both sides to remove the cover. (As shown in figure 3)

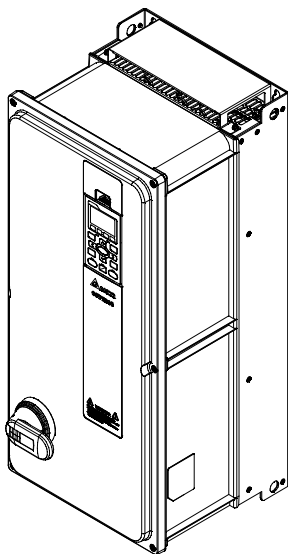

Figure 1

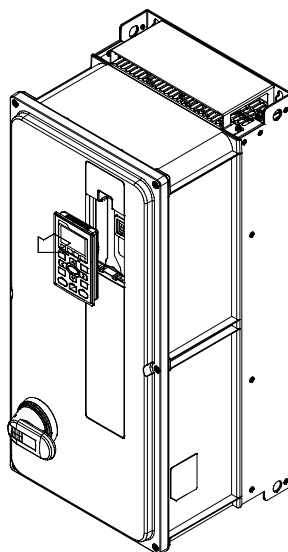

Figure 2

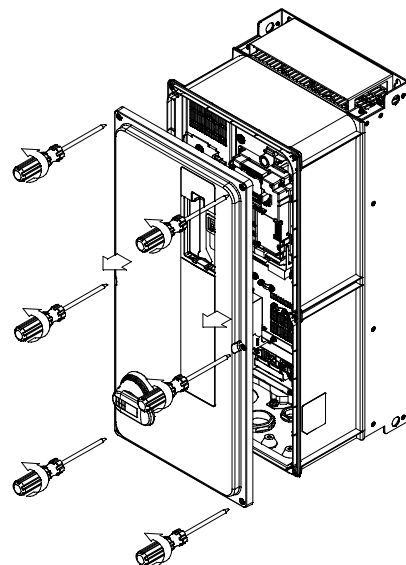

Figure 3

Frame D0&D

Screw torque: 14~16Kg-cm [12.1~13.9lb-in.]

- 1) Remove the keypad. (As shown in figure 2)
- 2) Loosen the screws and press the tabs on both sides to remove the cover. (As shown in figure 3)

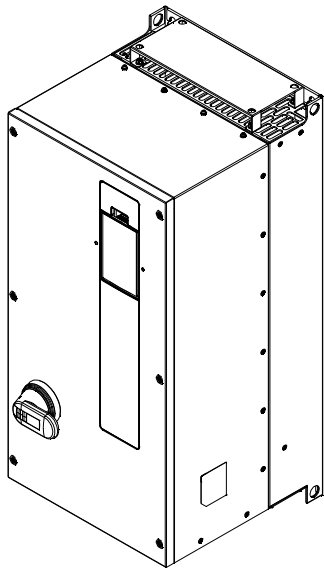

Figure 1

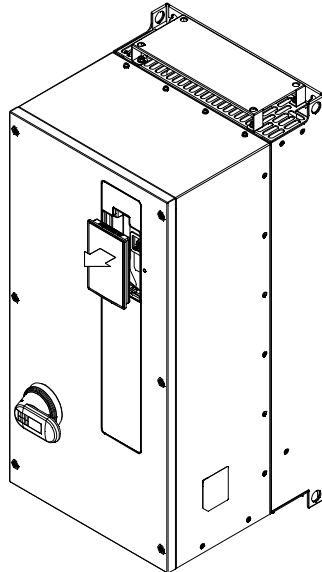

Figure 2

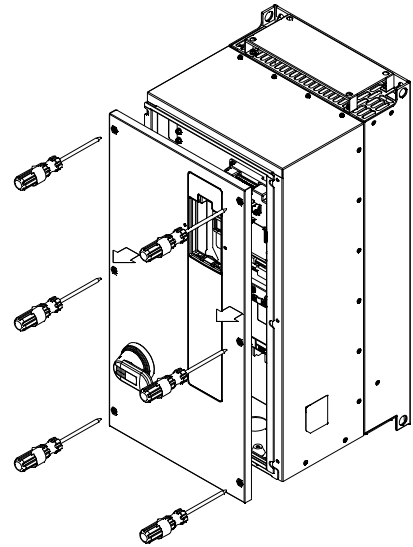
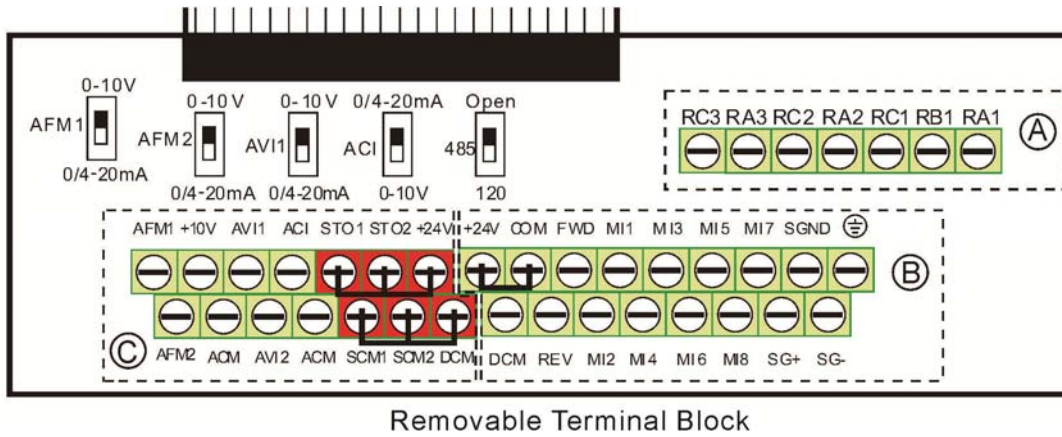

Figure 3

6-2 Specifications of Control Terminal



Wire Gauge: 26~16AWG (0.1281-1.318mm²);

Torque: (A) 5kg-cm [4.3lb-in.] (0.49 Nm) (As shown in figure above)

(B) 8kg-cm [6.94 lb-in.] (0.78 Nm) (As shown in figure above)

(C) 2kg-cm [1.73 lb-in.] (0.19 Nm) (As shown in figure above)

Wiring precautions:

- Reserves 5mm and properly install the wire into the terminal; fasten the installation by a slotted screwdriver. If the wire is stripped, sort the wire before install into the terminal.
- Flathead screwdriver: blade width 3.5mm, tip thickness 0.6mm
- In the figure above, the factory setting for STO1, STO2, +24V and SCM1, SCM2, DCM are short circuit. The factory setting for +24V-COM is short circuit and SINK mode (NPN); please refer to Chapter 4 Wiring for more detail.

Terminals	Terminal Function	Factory Setting (NPN mode)
+24V	Digital control signal common (Source)	+24V±5% 200mA
COM	Digital control signal common (Sink)	Common for multi-function input terminals
FWD	Forward-Stop command	FWD-DCM: ON→ forward running OFF→ deceleration to stop
REV	Reverse-Stop command	REV-DCM: ON→ reverse running OFF→ deceleration to stop
MI1 ~ MI8	Multi-function input 1~8	Refer to parameters 02-01~02-08 to program the multi-function inputs MI1~MI8. Source mode ON: the activation current is 3.3mA ≥ 11Vdc OFF: cut-off voltage ≤ 5Vdc Sink Mode ON: the activation current is 3.3mA ≤ 13Vdc OFF: cut-off voltage ≥ 19Vdc
MCM	Multi-function Output Common	Max 48Vdc 50mA
RA1	Multi-function relay output 1 (N.O.) a	Resistive Load: 3A(N.O.)/3A(N.C.) 250VAC 5A(N.O.)/3A(N.C.) 30VDC Inductive Load (COS 0.4): 1.2A(N.O.)/1.2A(N.C.) 250VAC It is used to output each monitor signal, such as drive is in
RB1	Multi-function relay output 1 (N.C.) b	
RC1	Multi-function relay common	
RA2	Multi-function relay output 2 (N.O.) a	
RB2	Multi-function relay output 2 (N.C.) b	

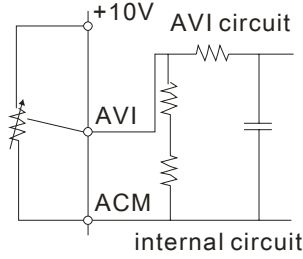
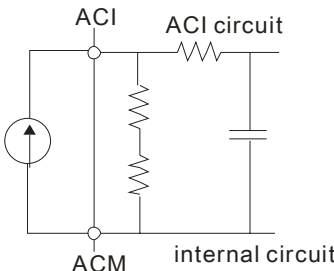
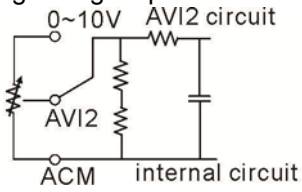
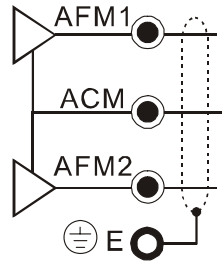
Terminals	Terminal Function	Factory Setting (NPN mode)
RC2	Multi-function relay common	operation, frequency attained or overload indication. Note: Terminal RA1 supports N.O. and N.C. But terminal RA2 and RA3 support only N.O.
RA3	Multi-function relay output 2 (N.O.) a	
RC3	Multi-function relay common	
+10V	Potentiometer power supply	Analog frequency setting: +10Vdc 20mA
AVI	Analog voltage input 	Impedance: 20kΩ Range: 0~20mA/4~20mA/0~10V =0~Max. Output Frequency (Pr.01-00) AVI switch, factory setting is 0~10V
ACI	Analog current input 	Impedance: 250Ω Range: 0~20mA/4~20mA/0~10V = 0 ~ Max. Output Frequency (Pr.01-00) ACI Switch, factory setting is 4~20mA
AVI2	Analog voltage input 	Impedance: 20kΩ Range: 0 ~ 10VDC=0~ Max. Output Frequency (Pr.01-00)
AFM1		0~10V Max. output current 2mA, Max. load 5kΩ 0~20mA Max. load 500Ω Output current: 20mA max Resolution: 0~10V corresponds to Max. operation frequency Range: 0~10V → 4~20mA AFM Switch, factory setting is 0~10V
AFM2		
ACM	Analog Signal Common	Common for analog terminals
STO1	Default setting is shorted Power removal safety function for EN954-1 and IEC/EN61508 When STO1~SCM1;STO2~SCM2 is activated, the activation current is 3.3mA ≥ 11Vdc	
SCM1		
STO2		
SCM2		
SG+	Modbus RS-485	
SG-		
SGND		
RJ-45	PIN 1,2,7,8 : Reserved PIN 4: SG-	PIN 3, 6: SGND PIN 5: SG+

NOTE: Wire size of analog control signals: 18 AWG (0.75 mm²) with shielded wire

Analog input terminals (AVI1, AVI2, ACI, ACM)

- ☑ Analog input signals are easily affected by external noise. Use shielded wiring and keep it as short as possible (<20m) with proper grounding. If the noise is inductive, connecting the shield to terminal ACM can bring improvement.
- ☑ If the analog input signals are affected by noise from the AC motor drive, please connect a capacitor and ferrite core as indicated in the following diagram.

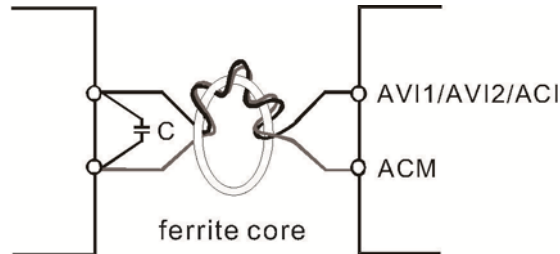

Wind each wires 3 times or more around the core

Digital inputs (FWD, REV, MI1~MI8, COM)

- ☑ When using contacts or switches to control the digital inputs, please use high quality components to avoid contact bounce.
- ☑ The “COM” terminal is the common side of the photo-coupler. Any of wiring method, the “common point” of all photo-coupler must be the “COM”.
- ☑ When the photo-coupler is using internal power supply, the switch connection for Sink and Source as below:
MI-DCM: Sink mode, MI-+24 V: Source mode
- ☑ When the photo-coupler is using external power supply, remove the short circuit cable between the +24V and COM terminals. The connection mode is Sink mode or Source mode is according to the below:
The “+” of 24V connecting to “COM: Sink mode
The “-” of 24V connecting to COM: Source mode

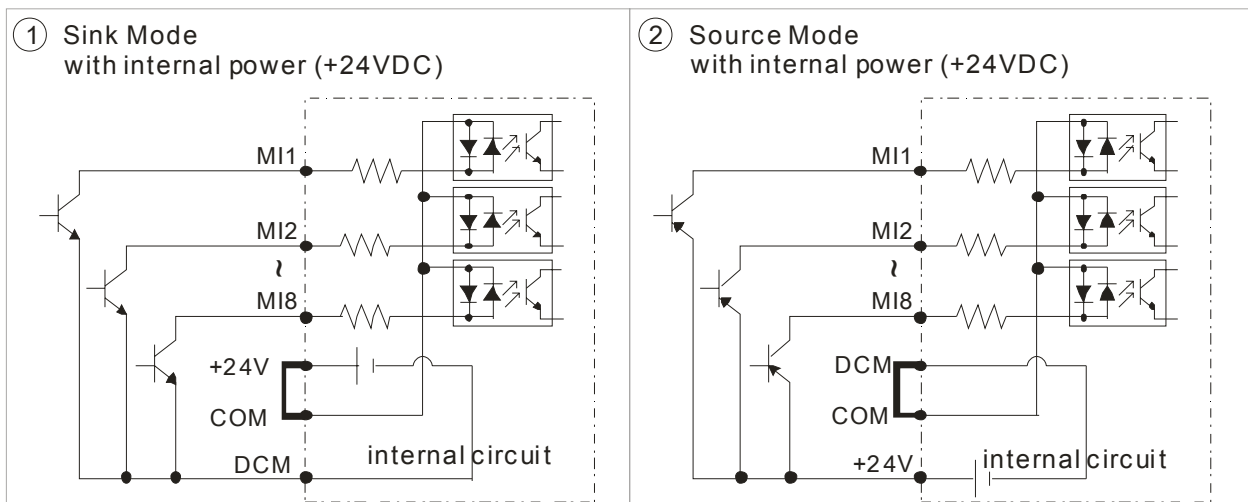

③ Sink Mode with external power

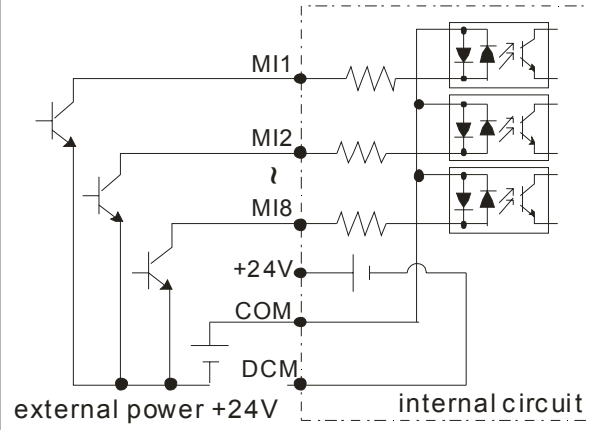

④ Source Mode with external power

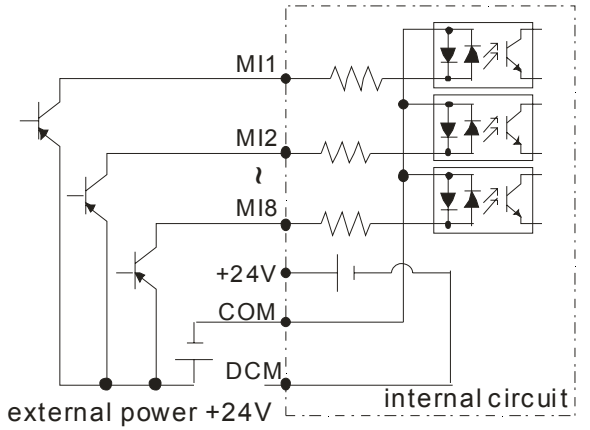

6-3 Remove the Terminal Block

1. Loosen the screws by screwdriver. (As shown in figure below).

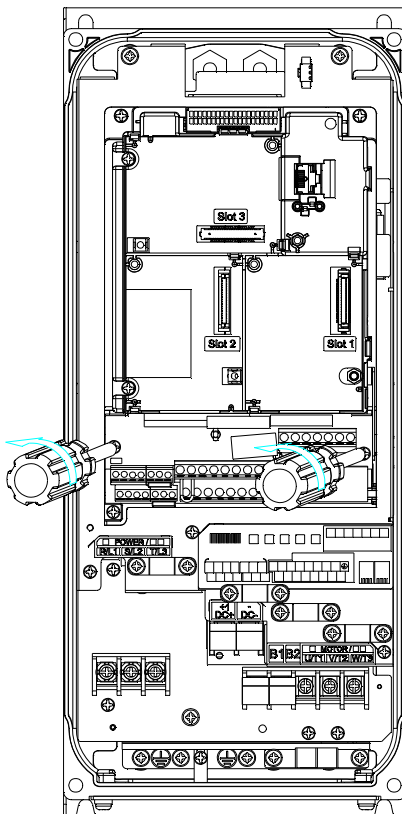

2. Remove the control board by pulling it out for a distance 6~8 cm (as 1 in the figure) then lift the control board upward (as 2 in the figure).

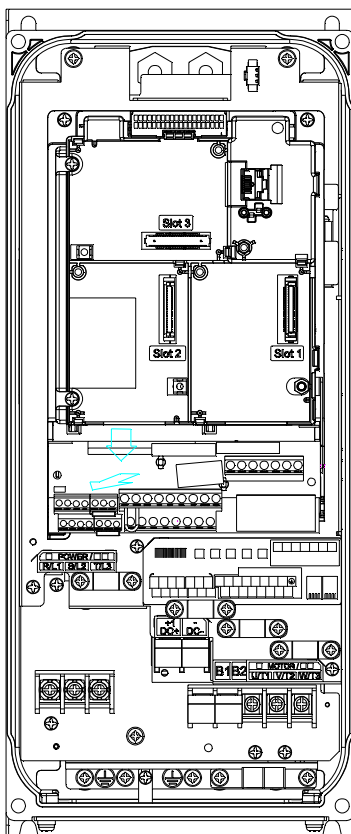

[The page intentionally left blank]

Chapter 7 Optional Accessories

7-1 All Brake Resistors and Brake Units Used in AC Motor Drives

7-2 Non-fuse Circuit Breaker

7-3 Fuse Specification Chart

7-4 AC/DC Reactor

7-5 Zero Phase Reactor

7-6 EMC Filter

7-7 Panel Mounting

7-8 Fan Kit

7-9 USB/RS-485 Communication Interface IF6530

The optional accessories listed in this chapter are available upon request. Installing additional accessories to your drive would substantially improve the drive’s performance. Please select an applicable accessory according to your need or contact the local distributor for suggestion.

7-1 All Brake Resistors and Brake Units Used in AC Motor Drives

Applicable Motor		*1 125%Braking Torque 10%ED					*2 Max. Brake Torque			
HP	kW	Braking Torque (kg-m)	Brake Unit	*3Braking Resistor series for each Brake Unit	Resistor value spec. for each AC motor Drive	Total Braking Current (A)	Min. Resistor Value (Ω)	Max. Total Braking Current (A)	Peak Power (kW)	
			*4VFDB							
1	0.7	0.5	-	BR080W750*1	80W750Ω	1	190.0	4	3.0	
2	1.5	1.0	-	BR080W750*1	80W750Ω	1	190.0	4	3.0	
3	2.2	1.5	-	BR200W360*1	200W360Ω	2.1	126.7	6	4.6	
5	3.7	2.5	-	BR300W250*1	300W250Ω	3	108.6	7	5.3	
5.5	4.0	2.7	-	BR400W150*1	400W150Ω	5.1	84.4	9	6.8	
7.5	5.5	3.7	-	BR1K0W075*1	1000W75Ω	10.2	54.3	14	10.6	
10	7.5	5.1	-	BR1K0W075*1	1000W75Ω	10.2	54.3	14	10.6	
15	11	7.5	-	BR1K0W075*1	1000W75Ω	10.2	47.5	16	12.2	
20	15	10.2	-	BR1K5W043*1	1500W43Ω	17.6	42.2	18	13.7	
25	18	12.2	-	BR1K0W016*2	2000W32Ω	24	26.2	29	22.0	
30	22	14.9	-	BR1K0W016*2	2000W32Ω	24	23.0	33	25.1	
40	30	20.3	-	BR1K5W013*2	3000W26Ω	29	23.0	33	25.1	
50	37	25.1	4045*1	BR1K0W016*4	4000W16Ω	47.5	14.1	54	41.0	
60	45	30.5	4045*1	BR1K2W015*4	4800W15Ω	50	12.7	60	45.6	
75	55	37.2	4030*2	BR1K5W013*4	6000W13Ω	59	12.7	60	45.6	
100	75	50.8	4045*2	BR1K0W5P1*4	8000W10.2Ω	76	9.5	80	60.8	
125	90	60.9	4045*2	BR1K2W015*4	9600W7.5Ω	9600W7.5Ω	100	120	91.2	

- *1 Calculation for 125% brake torque: $(kW) \times 125\% \times 0.8$; where 0.8 is motor efficiency.
- *2 Because there is a resistor limit of power consumption, the longest operation time for 10%ED is 10sec (on: 10sec/ off: 90sec).
- *3 Please refer to the Brake Performance Curve for “Operation Duration & ED” vs. “Braking Current”.
- *4 For heat dissipation, a resistor of 400W or lower should be fixed to the frame and maintain the surface temperature below 50 °C; a resistor of 1000W and above should maintain the surface temperature below 600°C .
- *4 Please refer to VFDB series Braking Module Instruction for more detail on braking resistor.

NOTE

- Definition for Brake Usage ED%
 Explanation: The definition of the brake usage ED (%) is for assurance of enough time for the brake unit and brake resistor to dissipate away heat generated by braking. When the brake resistor heats up, the resistance would increase with temperature, and brake torque would decrease accordingly. Recommended cycle time is one minute.

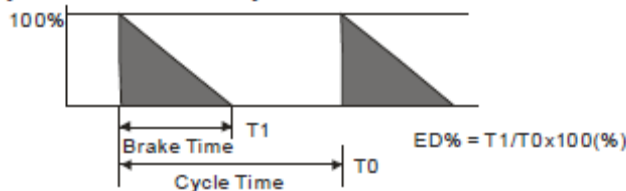

For safety concern, install an overload relay (O.L) between the brake unit and the brake resistor in conjunction with the magnetic contactor (MC) prior to the drive for abnormal protection. The purpose of installing the thermal overload relay is to protect the brake resistor from damage due to frequent brake, or due to brake unit keeping operating resulted from unusual high input voltage. Under such circumstance, just turn off the power to prevent damaging the brake resistor.

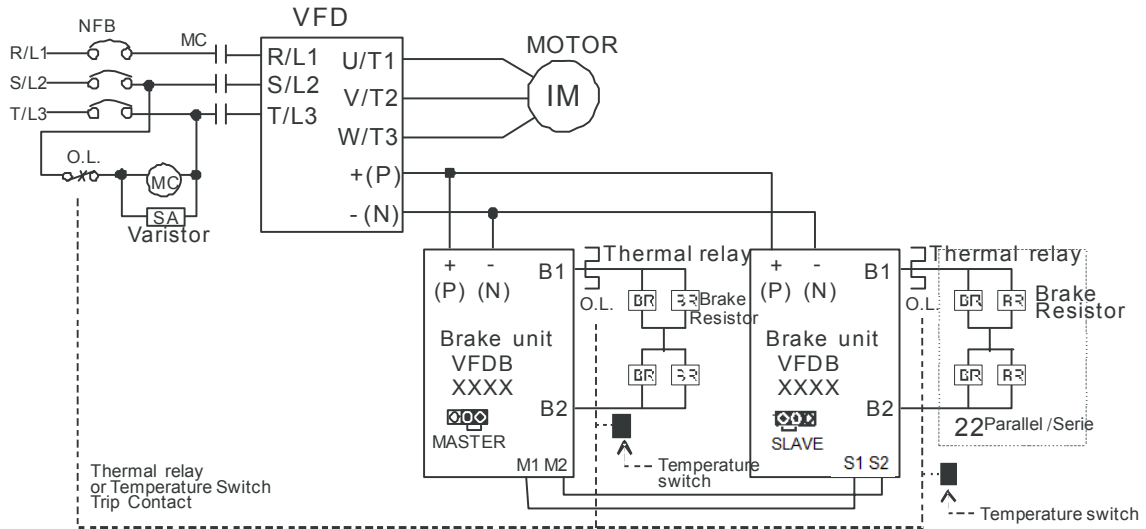

- When AC Drive is equipped with a DC reactor, please read user manual to know the wiring method of input circuit of brake unit + (P).
- Do Not connect input circuit - (N) to the neutral point of the power system.

2. If damage to the drive or other equipment is due to the fact that the brake resistors and brake modules in use are not provided by Delta, the warranty will be void.
3. Take into consideration the safety of the environment when installing the brake resistors. If the minimum resistance value is to be utilized, consult local dealers for the calculation of Watt figures.
4. When using more than 2 brake units, equivalent resistor value of parallel brake unit can't be less than the value in the column "Minimum Equivalent Resistor Value for Each AC Drive" (the right-most column in the table). Please read the wiring information in the user manual of brake unit thoroughly prior to operation
5. This chart is for normal usage; if the AC motor drive is applied for frequent braking, it is suggested to enlarge 2~3 times of the Watts.
6. Thermal Relay:

Thermal relay selection is basing on its overload capability. A standard braking capacity for CFP2000 is 10%ED (Tripping time=10s). The figure below is an example of 406V, 110kw AC motor drive. It requires the thermal relay to take 260% overload capacity in 10s (Host starting) and the braking current is 126A. In this case, user should select a rated 50A thermal relay. The property of each thermal relay may vary among different manufacturer, please carefully read specification.

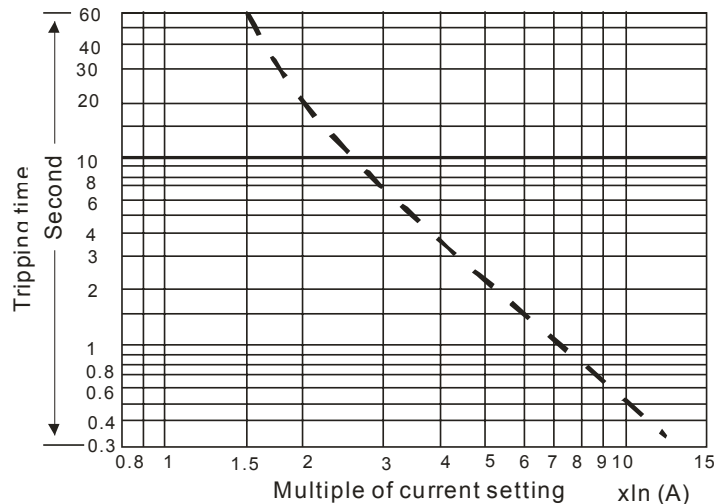

7-2 Non-fuse Circuit Breaker

Comply with UL standard: Per UL 508, paragraph 45.8.4, part a.

The rated current of the breaker shall be 1.6~2.6 times of the maximum rated input current of AC motor drive.

Model	Recommended non-fuse breaker (A)
VFD007FP4EA-41/ VFD007FP4EA-52/ VFD007FP4EA-52S	6
VFD015FP4EA-41/ VFD015FP4EA-52/ VFD015FP4EA-52S	6
VFD022FP4EA-41/ VFD022FP4EA-52/ VFD022FP4EA-52S	10
VFD040FP4EA-41/ VFD040FP4EA-52/ VFD040FP4EA-52S	15
VFD037FP4EA-41/ VFD037FP4EA-52/ VFD037FP4EA-52S	15
VFD055FP4EA-41/ VFD055FP4EA-52/ VFD055FP4EA-52S	20
VFD075FP4EA-41/ VFD075FP4EA-52/ VFD075FP4EA-52S	25
VFD110FP4EA-41/ VFD110FP4EA-52/ VFD110FP4EA-52S	35
VFD150FP4EA-41/ VFD150FP4EA-52/ VFD150FP4EA-52S	50
VFD185FP4EA-41/ VFD185FP4EA-52/ VFD185FP4EA-52S	60
VFD220FP4EA-41/ VFD220FP4EA-52/ VFD220FP4EA-52S	60
VFD300FP4EA-41/ VFD300FP4EA-52/ VFD300FP4EA-52S	90
VFD370FP4EA-41/ VFD370FP4EA-52/ VFD370FP4EA-52S	100
VFD450FP4EA-41/ VFD450FP4EA-52/ VFD450FP4EA-52S	125
VFD550FP4EA-41/ VFD550FP4EA-52/ VFD550FP4EA-52S	150
VFD750FP4EA-41/ VFD750FP4EA-52/ VFD750FP4EA-52S	200
VFD900FP4EA-41/ VFD900FP4EA-52/ VFD900FP4EA-52S	250

7-3 Fuse Specification Chart

Fuses with specification smaller than the following table indicates are allowed.

- ☑ UL fuse types for short-circuit protection of input. “For installation in the United States, branch circuit protection must be provided in accordance with the National Electrical Code (NEC) and any applicable local codes. To fulfill this requirement, use the UL classified fuses”
- ☑ “For installation in Canada, branch circuit protection must be provided in accordance with Canadian Electrical Code and any applicable provincial codes. To fulfill this requirement, use the UL classified fuses”

Model	Input Current I(A)		Line Fuse	
	Light Duty	Normal Duty	I (A)	Bussmann P/N
VFD007FP4EA-41/ VFD007FP4EA-52/ VFD007FP4EA-52S	3	1.7	6	JJS-6
VFD015FP4EA-41/ VFD015FP4EA-52/ VFD015FP4EA-52S	4.2	3	6	JJS-6
VFD022FP4EA-41/ VFD022FP4EA-52/ VFD022FP4EA-52S	5.5	4	10	JJS-10
VFD040FP4EA-41/ VFD040FP4EA-52/ VFD040FP4EA-52S	8.5	6	15	JJS-15
VFD037FP4EA-41/ VFD037FP4EA-52/ VFD037FP4EA-52S	10.5	9	15	JJS-15
VFD055FP4EA-41/ VFD055FP4EA-52/ VFD055FP4EA-52S	13	10.5	20	JJS-20
VFD075FP4EA-41/ VFD075FP4EA-52/ VFD075FP4EA-52S	18	12	25	JJS-25
VFD110FP4EA-41/ VFD110FP4EA-52/ VFD110FP4EA-52S	24	18	35	JJS-35
VFD150FP4EA-41/ VFD150FP4EA-52/ VFD150FP4EA-52S	32	24	50	JJS-50
VFD185FP4EA-41/ VFD185FP4EA-52/ VFD185FP4EA-52S	38	32	60	JJS-60
VFD220FP4EA-41/ VFD220FP4EA-52/ VFD220FP4EA-52S	45	38	60	JJS-60
VFD300FP4EA-41/ VFD300FP4EA-52/ VFD300FP4EA-52S	60	45	90	JJS-90
VFD370FP4EA-41/ VFD370FP4EA-52/ VFD370FP4EA-52S	73	60	100	JJS-100
VFD450FP4EA-41/ VFD450FP4EA-52/ VFD450FP4EA-52S	91	73	125	JJS-125
VFD550FP4EA-41/ VFD550FP4EA-52/ VFD550FP4EA-52S	110	91	150	JJS-150
VFD750FP4EA-41/ VFD750FP4EA-52/ VFD750FP4EA-52S	150	110	200	JJS-200
VFD900FP4EA-41/ VFD900FP4EA-52/ VFD900FP4EA-52S	180	150	250	JJS-250

7-4 AC/DC Reactor

AC Input Reactor

When the AC Motor Drive is connected directly to a large-capacity power transformer (500kVA or above) or when a phase lead capacitor is switched, excess peak currents may occur in the power input circuit due to the load changes and the converter section may be damaged. To avoid this, it is recommend using a serial connected AC input reactor (3%) at the AC Motor Drive mains input side to reduce the current and improve the input power efficiency.

Installation

An AC input reactor is installed in series with the mains power to the three input phases R S T as shown below:

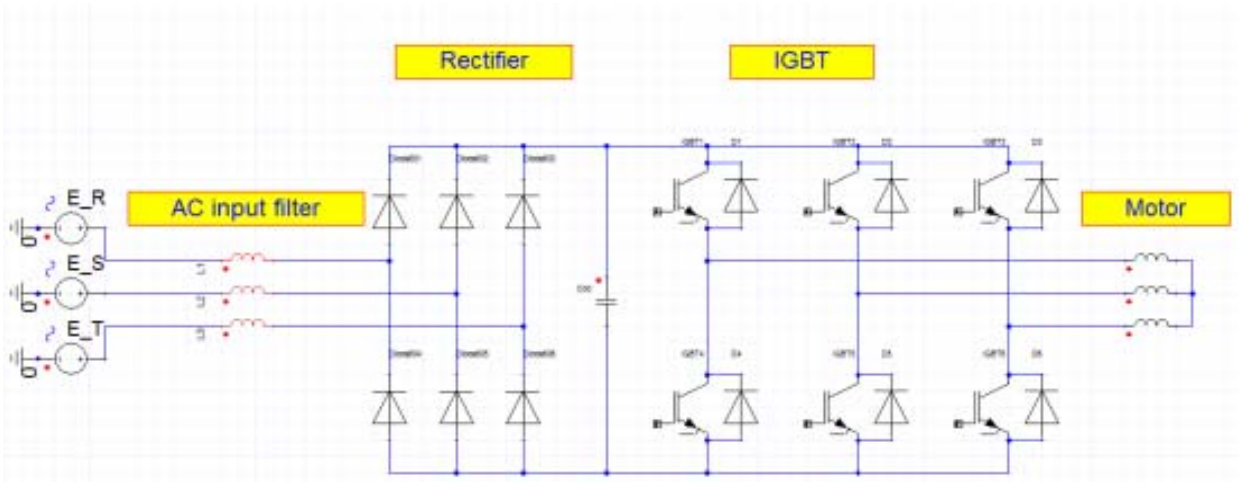

Connecting an AC input reactor

AC Input Reactor

380V~460V/ 50~60Hz

Type	KW	HP	Rated Amps of AC Reactor(Arms)		Max. continuous Amps (Arms)		3% impedance(mH)		5% impedance(mH)		Built-in DC reactor	3% Input AC reactor Delta part # (Note 1)	
			Normal Duty	Light Duty	Normal Duty	Light Duty	Normal Duty	Light Duty	Normal Duty	Light Duty		Normal Duty	Light Duty
007	0.75	1	1.7	3	2.72	3.9	13.344	8.102	22.241	13.502	O	N/A	DR003A0810
015	1.5	2	3	4.2*	4.8	5.46*	8.102	6.077	13.502	10.127	O	DR003A0810	DR004A0607
022	2.2	3	4	5.5*	6.4	7.15*	6.077	4.05	10.127	6.752	O	DR004A0607	DR006A0405
037	3.7	5	6	8.5*	9.6	11.05*	4.05	2.7	6.752	4.501	O	DR006A0405	DR009A0270
040	4	5	9	10.5	14.4	13.65	2.7	2.315	4.501	3.858	O	DR009A0270	DR010A0231
055	5.5	7.5	10.5	13*	16.8	16.9*	2.315	2.025	3.858	3.375	O	DR010A0231	DR012A0202
075	7.5	10	12	18*	19.2	23.4*	2.025	1.174	3.375	1.957	O	DR012A0202	DR018A0117
110	11	15	18	24*	28.8	31.2*	1.174	0.881	1.957	1.468	O	DR018A0117	DR024AP881
150	15	20	24	32*	38.4	41.6*	0.881	0.66	1.468	1.101	O	DR024AP881	DR032AP660
185	18.5	25	32	38*	51.2	49.4*	0.66	0.639	1.101	1.066	O	DR032AP660	DR038AP639
220	22	30	38	45	60.8	58.5	0.639	0.541	1.066	0.9	O	DR038AP639	DR045AP541

Type	KW	HP	Rated Amps of AC Reactor(Arms)		Max. continuous Amps (Arms)		3% impedance(mH)		5% impedance(mH)		Built-in DC reactor	3% Input AC reactor Delta part # (Note 1)	
			Normal Duty	Light Duty	Normal Duty	Light Duty	Normal Duty	Light Duty	Normal Duty	Light Duty		Normal Duty	Light Duty
300	30	40	45	60*	72	78*	0.541	0.405	0.9	0.675	O	DR045AP541	DR060AP405
370	37	50	60	73*	96	94.9*	0.405	0.334	0.675	0.555	O	DR060AP405	DR073AP334
450	45	60	73	91	116.8	118.3	0.334	0.267	0.555	0.445	O	DR073AP334	DR091AP267
550	55	75	91	110	145.6	143	0.267	0.221	0.445	0.368	O	DR091AP267	DR110AP221
750	75	100	110	150	176	195	0.221	0.156	0.368	0.259	O	DR110AP221	DR150AP162
900	90	125	150	180	240	234	0.162	0.135	0.27	0.225	O	DR150AP162	DR180AP135

Note 1: AC input reactor is designed with 3% system impedance, if you have any other requirements please contact Delta for detail.

The following table is spec. of THDi that Delta AC motor drives use with AC reactors.

Motor Drive Spec	With Built in DC Reactor (Frame D above)		
Reactor Spec.	Without installation AC/DC Reactor	3% Input AC Reactor	5% Input AC Reactor
5th	31.16%	27.01%	25.5%
7th	23.18%	9.54%	8.75%
11th	8.6%	4.5%	4.2%
13th	7.9%	0.22%	0.17%
THDi	42.28%	30.5%	28.4%
Note:	THDi may have some difference due to different installation conditions and environment.		

THDi Spec.

AC Output Reactor

If the length of cable between AC motor drive and motor is too long, it may make AC motor drive trigger protection mechanism for GF (Ground Fault), OV (Over Current) and the AC motor drive stops running. The cause is the over long motor cable will generate extremely large stray capacitance, make common mode current of 3-phase output get too large and then trigger GF protection mechanism; OC protection is triggered which is caused by stray capacitance of cable-cable and cable-ground are getting larger, and its surge current makes AC motor drive output over large current. To prevent from the common mode current that stray capacitance generates, set up AC output reactor between AC motor drive and motor to increase the high frequency impedance.

Power transistor is switched via PWM to control the output voltage and frequency for AC motor drive. During the switch process, impulse voltage (dv/dt) rises and falls rapidly will make inner voltage of motor distribute unequally, and then the isolation of motor will be getting worse, and have interference of bearing current and electromagnet. Especially when AC motor drive and motor are connected by long leading wire, the influence of damping of high frequency resonance and reflected voltage that caused by cable spreading parameters is getting large, and it will generate twice incoming voltage at motor side to be over voltage, destroy the isolation.

Installation

An AC input reactor is installed in series with the mains power to the three input phases R S T as shown below:

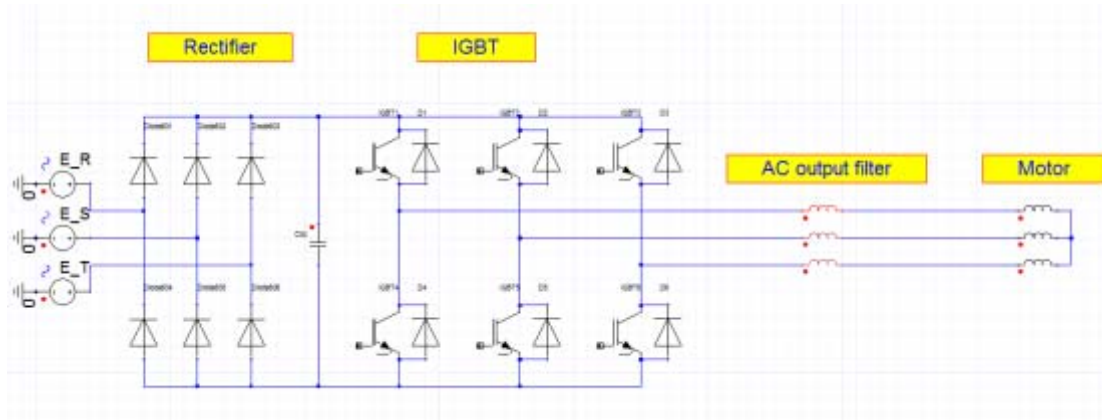

Connecting an AC output reactor

Specifications of AC output reactors (standard items)

The table below shows the specifications of AC output reactors (standard items).

380V~460V/ 50~60Hz

Type	KW	HP	Rated Amps of AC Reactor(Arms)		Max. continuous Amps (Arms)		3% impedance(mH)		5% impedance(mH)		Built-in DC reactor	3% Input AC reactor Delta part # (Note 2)	
			Normal Duty	Light Duty	Normal Duty	Light Duty	Normal Duty	Light Duty	Normal Duty	Light Duty		Normal Duty	Light Duty
007	0.75	1	2.8	3	4.48	3.6	8.102	8.102	13.502	13.502	X	N/A	N/A
015	1.5	2	3	4.2	4.8	5.04	8.102	6.077	13.502	10.127	X	N/A	N/A
022	2.2	3	4	5.5	6.4	6.6	6.077	4.050	10.127	6.752	X	N/A	N/A
037	3.7	5	6	8.5	9.6	10.2	4.050	2.700	6.752	4.501	X	N/A	N/A
040	4	5	9	10.5	14.4	12.6	2.700	2.315	4.501	3.858	X	N/A	N/A

Type	KW	HP	Rated Amps of AC Reactor(Arms)		Max. continuous Amps (Arms)		3% impedance(mH)		5% impedance(mH)		Built-in DC reactor	3% Input AC reactor Delta part # (Note 2)	
			Normal Duty	Light Duty	Normal Duty	Light Duty	Normal Duty	Light Duty	Normal Duty	Light Duty		Normal Duty	Light Duty
055	5.5	7.5	10.5	13	16.8	15.6	2.315	2.025	3.858	3.375	X	N/A	N/A
075	7.5	10	12	18	19.2	21.6	2.025	1.174	3.375	1.957	X	N/A	N/A
110	11	15	18	24	28.8	28.8	1.174	0.881	1.957	1.468	X	N/A	N/A
150	15	20	24	32	38.4	38.4	0.881	0.660	1.468	1.101	X	N/A	N/A
185	18.5	25	32	38	51.2	45.6	0.660	0.639	1.101	1.066	X	N/A	N/A
220	22	30	38	45	60.8	54	0.639	0.541	1.066	0.900	X	N/A	N/A
300	30	40	45	60	72	72	0.541	0.405	0.900	0.675	X	N/A	N/A
370	37	50	60	73	96	87.6	0.405	0.334	0.675	0.555	X	N/A	N/A
450	45	60	73	91	116.8	109.2	0.334	0.267	0.555	0.445	O	N/A	N/A
550	55	75	91	110	145.6	132	0.267	0.221	0.445	0.368	O	N/A	N/A
750	75	100	110	144	176	172.8	0.221	0.162	0.368	0.27	O	N/A	N/A
900	90	125	150	180	240	216	0.162	0.135	0.270	0.225	O	N/A	N/A

Note 2: AC output reactor is designed with 3% system impedance, it is in planning & design stage now, if you have any other requirements please contact Delta for detail.

The length of motor cable

1. Cable length suggestion for Drive in full load

If the length is too long, the stray capacitance between cables will increase and may cause leakage current. It will activate the protection of over current, increase leakage current or not insure the correction of current display. The worst case is that AC motor drive may damage. If more than one motor is connected to the AC motor drive, the total wiring length is the sum of the wiring length from AC motor drive to each motor.

For 460V series AC motor drives, when an overload relay is installed between the drive and the motor to protect motor from overheating, the connecting cable must be shorter than 50m.

However, the overload relay could still malfunction. To prevent this, install an AC output reactor (optional) to the drive and/or lower the carrier frequency setting (Pr. 00-17).

2. Effect of Surge voltages for motor and suggestion

When motor is driven by an AC motor drive with PWM control, the motor terminals will experience surge voltages easily due to power transistors operation of AC motor drive and cable capacitance.

When the motor cable is very long (especially for the 460V series), surge voltages may reduce insulation quality. To prevent this situation, please follow the rules below:

- Use a motor with enhanced insulation (Please refer to following charts)
- Connect an output reactor (optional) to the output terminals of the AC motor drive
- The length of the cable between AC motor drive and motor should be as short as possible (10 to 20 m or less)

The suggested motor shielded cable length in the following table complies with IEC 60034-17, which is suitable for motors with a rated voltage ≤ 500 Vac and with an insulation level of ≥ 1.35 kVp-p

Type	kW	HP	Rated Amps of AC Reactor (Arms)		Without installation AC output Reactor		3% Output AC reactor	
			Normal Duty	Light Duty	shielded cable (meter)	Non-shielded cable (meter)	shielded cable (meter)	Non-shielded cable (meter)
007	0.75	1	2.8	3	50	75	75	115
015	1.5	2	3	4.2	50	75	75	115
022	2.2	3	4	5.5	50	75	75	115
037	3.7	5	6	8.5	50	75	75	115
040	4	5	9	10.5	50	75	75	115
055	5.5	7.5	10.5	13	50	75	75	115
075	7.5	10	12	18	100	150	150	225
110	11	15	18	24	100	150	150	225
150	15	20	24	32	100	150	150	225
185	18.5	25	32	38	100	150	150	225
220	22	30	38	45	100	150	150	225
300	30	40	45	60	100	150	150	225
370	37	50	60	73	100	150	150	225
450	45	60	73	91	150	225	225	325
550	55	75	91	110	150	225	225	325
750	75	100	110	150	150	225	225	325
900	90	125	150	180	150	225	225	325

7-5 Zero Phase Reactors

Interferences can be suppressed by installing a zero phase reactor. When encounter any interference, buy and install a zero phase reactor.

Zero Phase Reactors for Signal Cable

To solve interference problems between signal cables and electric devices, install a zero phase reactor on signal cable. Install it on the signal cable which is the source of the interference to suppress the noise for a better signal. The model names and dimensions are in the table below.

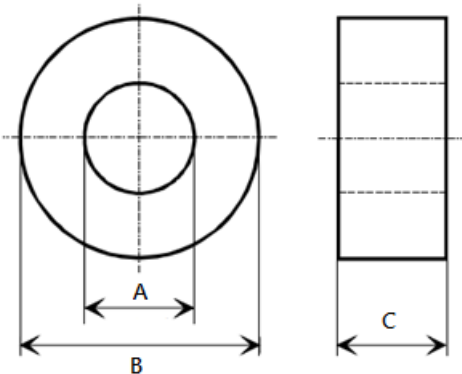

Unit: mm

Model	A	B	C
T60004L2016W620	10.7	17.8	8.0
T60004L2025W622	17.5	27.3	12.3

7-6 EMC Filter

Following table is the external EMC filter, user can choose corresponding zero phase reactor and suitable shielded cable length in accord to required noise emission and electromagnetic interference level to have the best configuration to suppress the electromagnetic interference .

When the application does not consider RE and only needs CE to comply with C2 or C1, there is no need to install zero phase reactor in input side.

CFP2000 Model	Input Current	Zero phase reactor	CE Cable Length				Radiation Emission
			EN61800-3				EN61800-3
			Category C2	Carrier frequency (Hz)	Category C1	Carrier frequency (Hz)	C2
VFD007FP4EA-XXX	4.3A	RF010FP00A	75m	≤8K	25m	≤4K ^{N1}	Pass
VFD015FP4EA-XXX	6A		75m	≤8K	25m	≤4K ^{N1}	Pass
VFD022FP4EA-XXX	8.1A		75m	≤8K	25m	≤4K ^{N1}	Pass
VFD040FP4EA-XXX	12.4A		75m	≤8K	25m	≤4K ^{N1}	Pass
VFD037FP4EA-XXX	16A		75m	≤8K	25m	≤4K ^{N1}	Pass
VFD055FP4EA-XXX	20A		75m	≤8K	25m	≤4K ^{N1}	Pass
VFD075FP4EA-XXX	22A		75m	≤8K	25m	≤4K ^{N1}	Pass
VFD110FP4EA-XXX	26A	RF006FP00A	75m	≤8K	25m	≤4K ^{N1}	Pass
VFD150FP4EA-XXX	35A		75m	≤8K	25m	≤4K ^{N1}	Pass
VFD185FP4EA-XXX	42A		75m	≤8K	25m	≤4K ^{N1}	Pass
VFD220FP4EA-XXX	50A		75m	≤8K	25m	≤4K ^{N1}	Pass
VFD300FP4EA-XXX	66A	RF002FP00A	75m	≤8K	25m	≤4K ^{N1}	Pass
VFD370FP4EA-XXX	80A		75m	≤8K	25m	≤4K ^{N1}	Pass
VFD450FP4EA-XXX	91A	-	75m	≤10K	25m	≤4K	Pass
VFD550FP4EA-XXX	110A	-	75m	≤10K	25m	≤4K	Pass
VFD750FP4EA-XXX	150A	-	75m	≤4K	25m	≤4K	Pass
VFD900FP4EA-XXX	180A	-	75m	≤4K	25m	≤4K	Pass

Note 1: To comply with the C1 specifications, an EMC magnetic core needs to be installed on the output side.

Note 2: For frame A~C to comply with EN 61800-3 C1 regulations (when the length of the cable is less than 25m, it complies with the C1 regulations.), a zero phase reactor has to be installed on the output side, Pass the three UVW cables through the zero phase reactor. But do not pass the earthing cable and the pig tail of the insulation through the zero phase reactor.

Note 3: When the length of the cable is longer than 25m, do not install the zero phase reactors listed in the table below. If the motor cables longer than 25m are connected to a zero phase reactor might cause the overheating of the iron core inside the zero phase reactor. That will damage the insulation of the cable and even endanger the life or physical safety of individuals.

Note 4: C2 specifications don't require installing a zero phase reactor.

EMC Filter Installation

All electrical equipment, including AC motor drives, will generate high-frequency/low-frequency noise and will interfere with peripheral equipment by radiation or conduction when in operation. By using an EMC filter with correct installation, much interference can be eliminated. It is recommended to use DELTA EMC filter to have the best interference elimination performance.

We assure that it can comply with following rules when AC motor drive and EMC filter are installed and wired according to user manual:

- EN61000-6-4
- EN61800-3: 1996
- EN55011 (1991) Class A Group 1 (1st Environment, restricted distribution)

General precaution

1. EMC filter and AC motor drive should be installed on the same metal plate.
2. Please install AC motor drive on footprint EMC filter or install EMC filter as close as possible to the AC motor drive.
3. Please wire as short as possible.
4. Metal plate should be grounded.
5. The cover of EMC filter and AC motor drive or grounding should be fixed on the metal plate and the contact area should be as large as possible.

Choose suitable motor cable and precautions

It is recommended to use isolated motor wires, as well as the signal wires and data wires.

The recommended specification of the shielding wire can be selected from the three types of shielding wire in Figure 1. (The left figure is a symmetric three-phase power cord with symmetric PE wires. The middle figure is a three-phased power cord with a separated PE wire. The right figure is the asymmetric three-phase power cord with a PE wire.)

The appropriate size of the power cord should be based on the rated current. Use of high density braided shielding prevents electromagnetic noise that results from high frequency signals, as well as prevents external sources from interfering with signal transmissions. Therefore we recommend two types shielded cables:

The appropriate size of the power cord should be based on the rated current. Use of high density braided shielding prevents electromagnetic noise that results from high frequency signals, as well as prevents external sources from interfering with signal transmissions. Therefore we recommend two types shielded cables:

- Braided copper shielding of 85% density or more (as shown in diagram 2a)
- 100% Wrapped in aluminum foil/ copper foil inside and in braided shielding of 80% or more outside (as shown in diagram 2b)

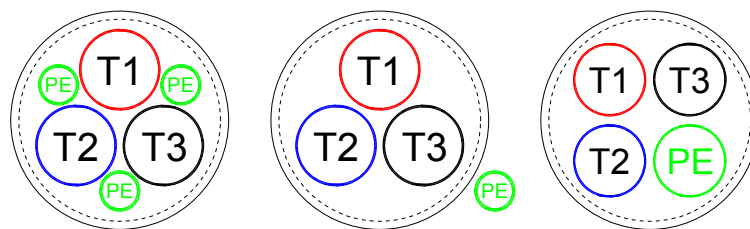

Figure 1 Types shielded cables recommended

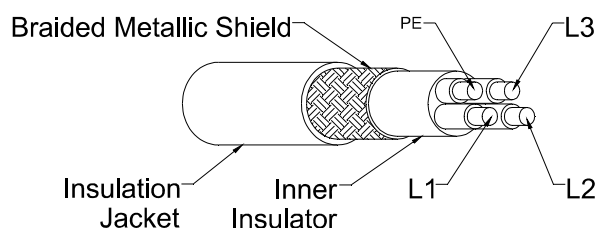

Figure 2a

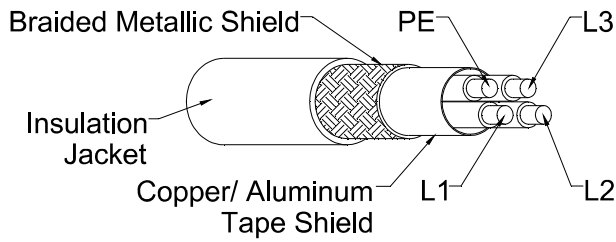

Figure 2b

Choose suitable motor cable and precautions

Improper installation and choice of motor cable will affect the performance of EMI filter. Be sure to observe the following precautions when selecting motor cable. The shielded layers of motor cable need to be grounded by using omega clips or pig tail. If omega clips are being used, the shielded layers need to have a 360 degree contact with the motor and the PE on motor drive.

If a pig tail is being used for grounding, the length of the pig tail cannot be more than 5 times of the wire size (WVW wire sizing)

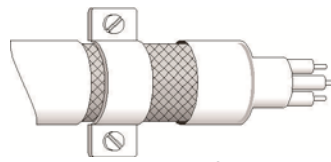

Figure 3

Zero phase reactor Dimensions

Unit: mm

<p>Frame A</p> <p> $> 28.7 \pm 0.1$ $< 43.1 \pm 0.1$ $< 18.5 \pm 0.1$ </p>	<p>Frame B</p> <p> $> 26.4 \pm 0.1$ $< 48.3 \pm 0.1$ $< 18.2 \pm 0.1$ </p>
<p>Frame C</p> <p> > 59.3 < 83.5 < 27.8 </p>	

EMC C1 with zero phase reactor installation

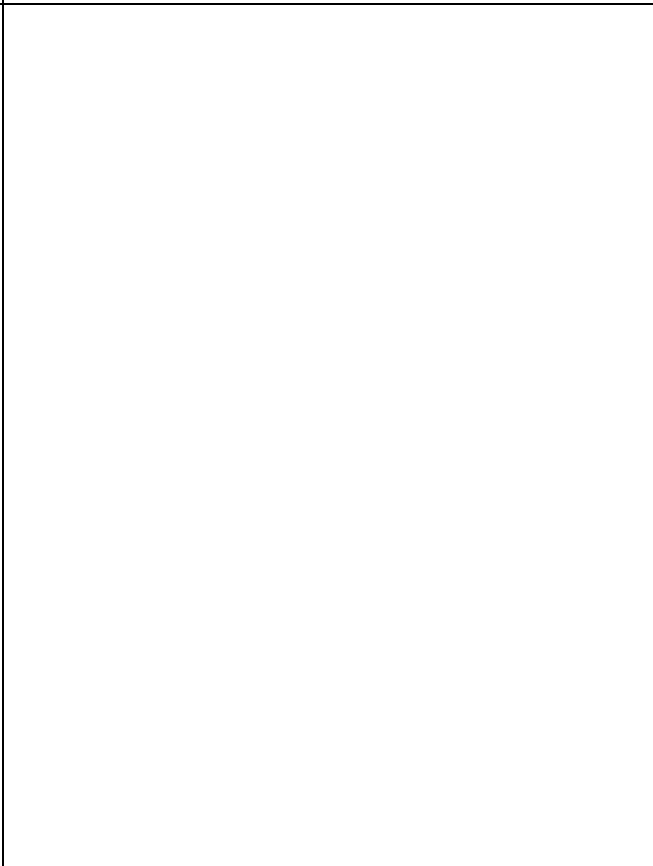
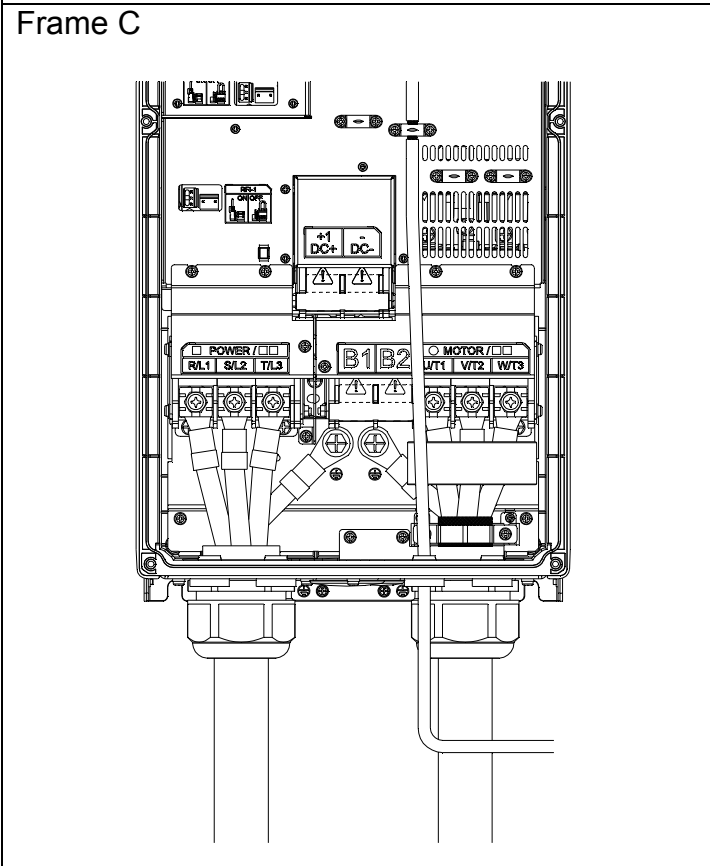
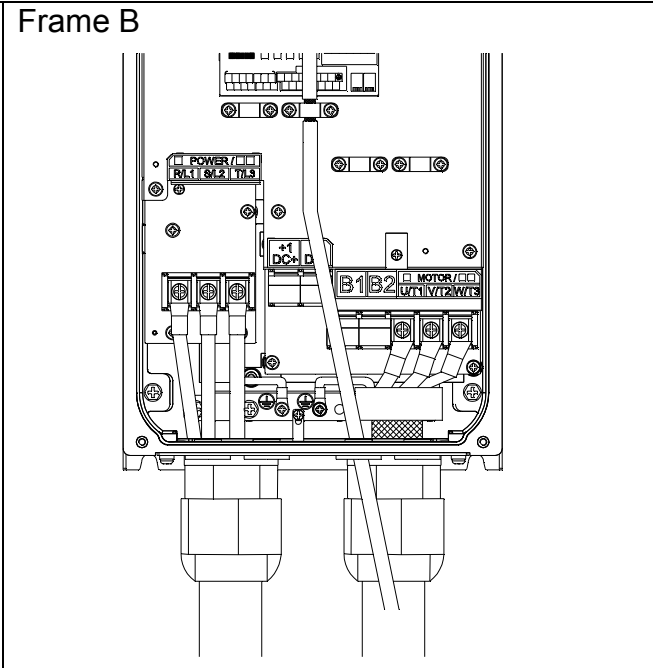
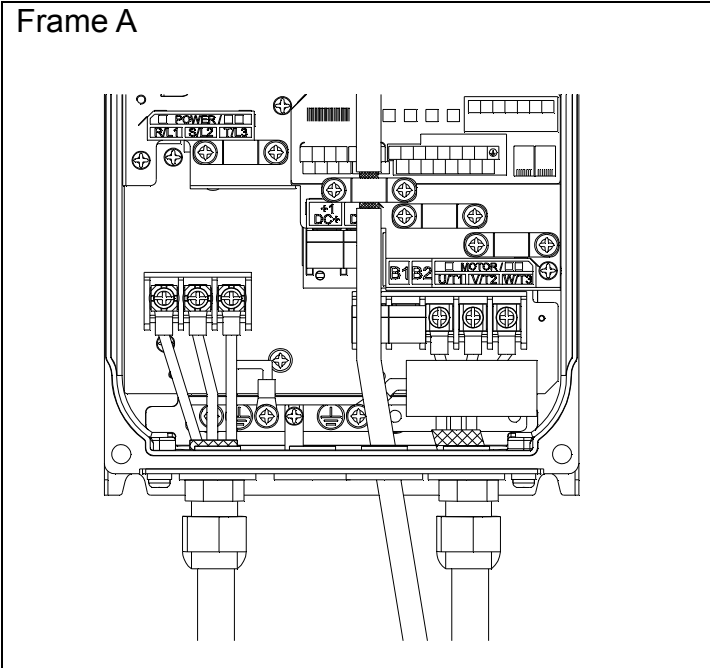

7-7 Panel Mounting (MKC-KPPK)

For MKC-KPPK model, user can choose wall mounting or embedded mounting, protection level is IP66.

It is applicable for the digital keypads (KPC-CC02).

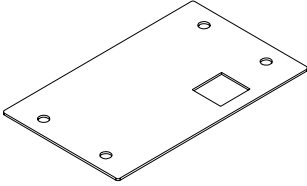
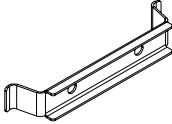
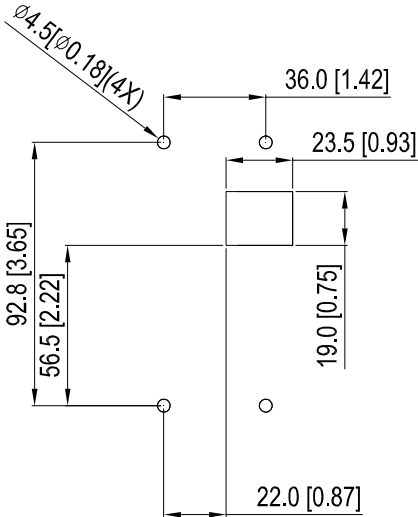
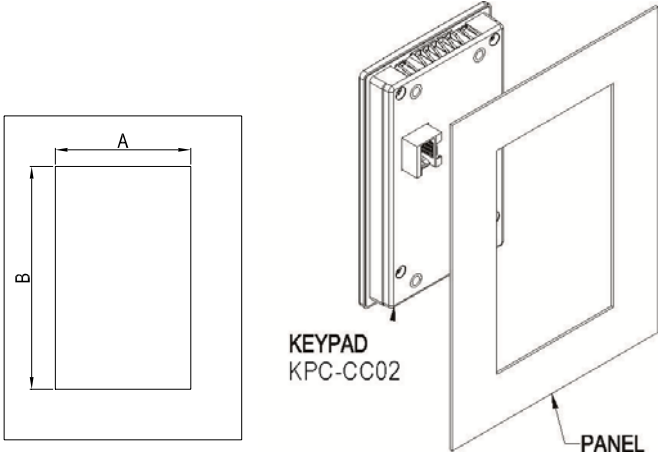
Wall Mounting	Embedded Mounting												
accessories*1 	accessories*2 												
Screw *4 ~M4*p 0.7 *L8mm Torque: 10-12kg-cm (8.7-10.4lb-in.)	Screw *4 ~M4*p 0.7 *L8mm Torque: 10-12kg-cm (8.7-10.4lb-in.)												
Panel cutout dimension Unit: mm [inch]	Panel cutout dimension Unit: mm [inch]												
													
	Normal cutout dimension <table border="1" data-bbox="802 1223 1466 1350"> <thead> <tr> <th>Panel thickness</th> <th>1.2mm</th> <th>1.6mm</th> <th>2.0mm</th> </tr> </thead> <tbody> <tr> <td>A</td> <td colspan="3">66.4 [2.614]</td> </tr> <tr> <td>B</td> <td>110.2 [4.339]</td> <td>111.3 [4.382]</td> <td>112.5 [4.429]</td> </tr> </tbody> </table>	Panel thickness	1.2mm	1.6mm	2.0mm	A	66.4 [2.614]			B	110.2 [4.339]	111.3 [4.382]	112.5 [4.429]
Panel thickness	1.2mm	1.6mm	2.0mm										
A	66.4 [2.614]												
B	110.2 [4.339]	111.3 [4.382]	112.5 [4.429]										
	*Deviation: ±0.15mm /±0.0059inch												
	Cutout dimension (Waterproof level: IP56) <table border="1" data-bbox="802 1447 1466 1615"> <thead> <tr> <th>Panel thickness</th> <th>1.2mm</th> <th>1.6mm</th> <th>2.0mm</th> </tr> </thead> <tbody> <tr> <td>A</td> <td colspan="3">66.4 [2.614]</td> </tr> <tr> <td>B</td> <td colspan="3">110.8 [4.362]</td> </tr> </tbody> </table>	Panel thickness	1.2mm	1.6mm	2.0mm	A	66.4 [2.614]			B	110.8 [4.362]		
Panel thickness	1.2mm	1.6mm	2.0mm										
A	66.4 [2.614]												
B	110.8 [4.362]												
	*Deviation: ±0.15mm /±0.0059inch												

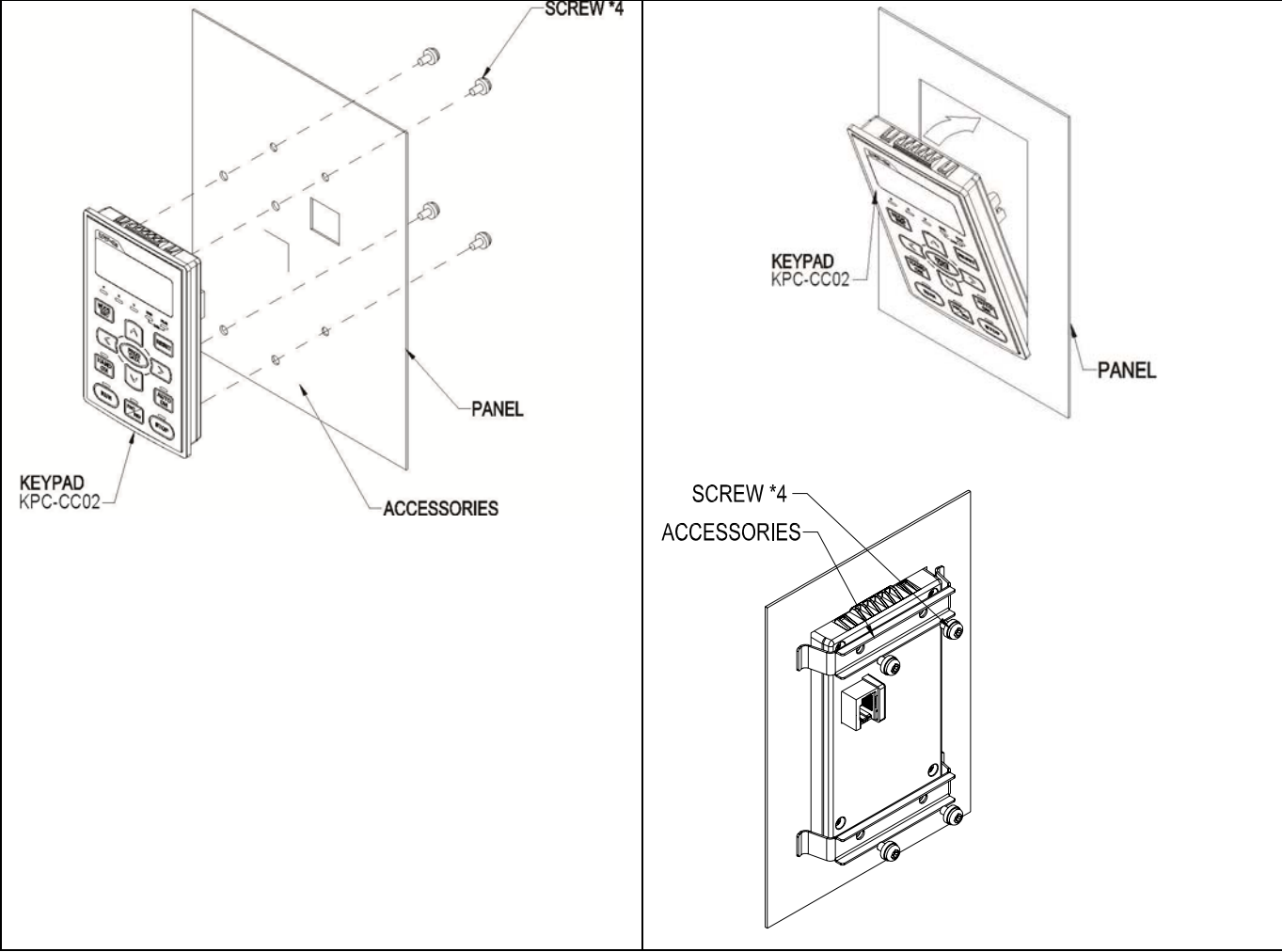

7-8 Fan Kit

■ Frames of the fan kit

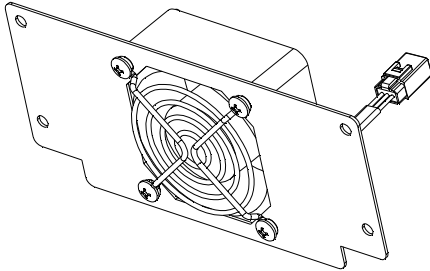
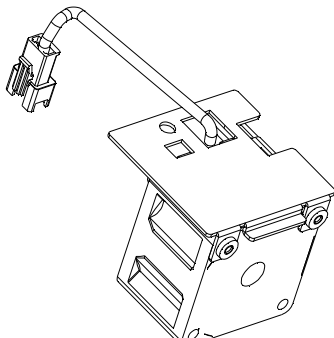
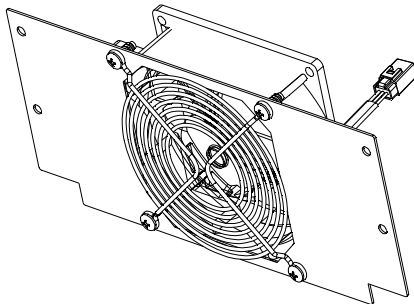
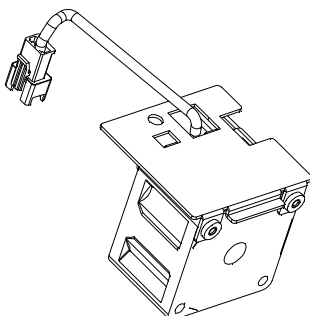
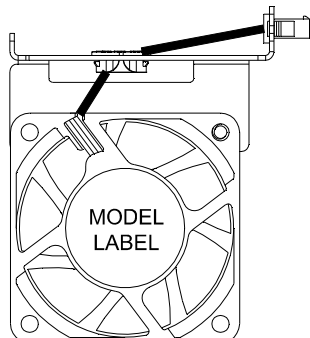
<p>Frame A</p> <p>Applicable Model VFD022FP4EA-52, VFD022FP4EA-52S VFD037FP4EA-52, VFD037FP4EA-52S, VFD040FP4EA-52, VFD040FP4EA-52S, VFD055FP4EA-52, VFD055FP4EA-52S, VFD075FP4EA-52, VFD075FP4EA-52S</p>	<p>Heat sink Fan Model 『MKFP-AFKM』</p> 
<p>Frame A</p> <p>Applicable Model VFD022FP4EA-52, VFD022FP4EA-52S VFD037FP4EA-52, VFD037FP4EA-52S, VFD040FP4EA-52, VFD040FP4EA-52S, VFD055FP4EA-52, VFD055FP4EA-52S, VFD075FP4EA-52, VFD075FP4EA-52S</p>	<p>Capacitor Fan Model 『MKFP-AFKB』</p> 
<p>Frame B</p> <p>Applicable Model VFD110FP4EA-52, VFD110FP4EA-52S, VFD150FP4EA-52, VFD150FP4EA-52S, VFD185FP4EA-52, VFD185FP4EA-52S, VFD220FP4EA-52, VFD220FP4EA-52S</p>	<p>Heat sink Fan Model 『MKFP-BFKM』</p> 
<p>Frame B</p> <p>Applicable Model VFD110FP4EA-52, VFD110FP4EA-52S, VFD150FP4EA-52, VFD150FP4EA-52S, VFD185FP4EA-52, VFD185FP4EA-52S, VFD220FP4EA-52, VFD220FP4EA-52S</p>	<p>Capacitor Fan Model 『MKFP-BFKB』</p> 
<p>Frame C</p> <p>Applicable Model VFD300FP4EA-52, VFD300FP4EA-52S VFD370FP4EA-52, VFD370FP4EA-52S VFD450FP4EA-52, VFD450FP4EA-52S VFD550FP4EA-52, VFD550FP4EA-52S VFD750FP4EA-52, VFD750FP4EA-52S VFD900FP4EA-52, VFD900FP4EA-52S</p>	<p>Capacitor Fan Model 『MKFP-CFKB』</p> 

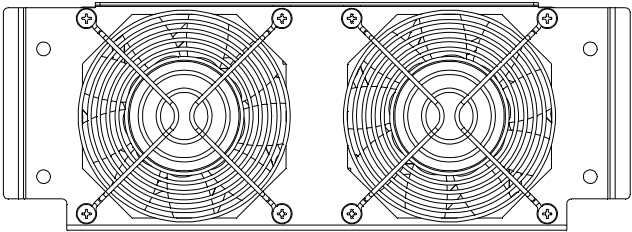
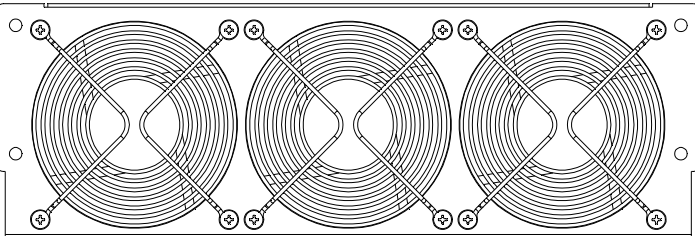
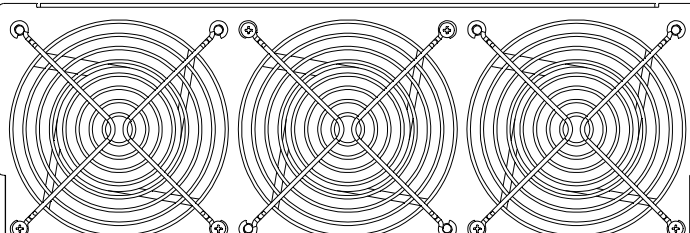
<p>Frame C</p> <p>Applicable Model VFD300FP4EA-52, VFD300FP4EA-52S VFD370FP4EA-52, VFD370FP4EA-52S</p>	<p>Heat sink Fan Model 『MKFP-CFKM』</p> 
<p>Frame D0</p> <p>Applicable Model VFD450FP4EA-52, VFD550FP4EA-52 VFD450FP4EA-52S, VFD550FP4EA-52S</p>	<p>Heat sink Fan Model 『MKFP-D0FKM』</p> 
<p>Frame D</p> <p>Applicable Model VFD750FP4EA-52, VFD900FP4EA-52 VFD750FP4EA-52S, VFD900FP4EA-52S</p>	<p>Heat sink Fan Model 『MKFP-DFKM』</p> 

■ Fan Removal

Frame A

Model 『MKFP-AFKM』 : Heat Sink Fan

Applicable model

VFD022FP4EA-52, VFD022FP4EA-52S, VFD037FP4EA-52, VFD037FP4EA-52S, VFD040FP4EA-52, VFD040FP4EA-52S, VFD055FP4EA-52, VFD055FP4EA-52S, VFD075FP4EA-52, VFD075FP4EA-52S

1. Refer to Figure 1, loosen the 4 screws then remove the fan kit.
2. Screw torque: 14~16kg-cm [12.2~13.9lb-in.]

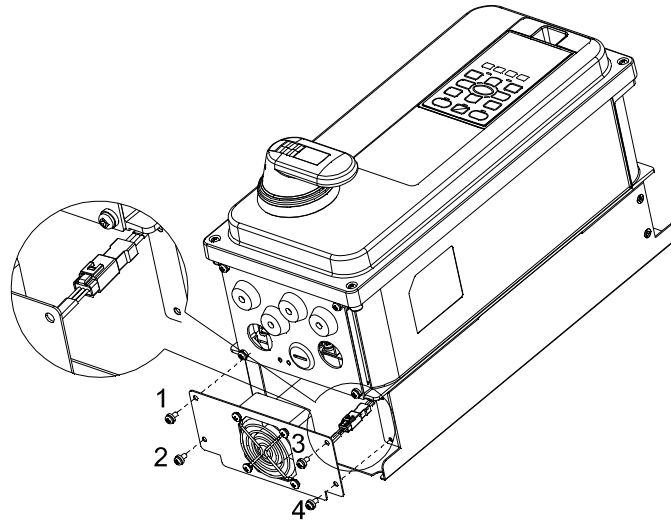

Figure 1

Frame A

Model 『MKFP-AFKB』 : Capacitor Fan

Applicable model

VFD007FP4EA-52, VFD007FP4EA-52S, VFD015FP4EA-52, VFD015FP4EA-52S, VFD022FP4EA-52, VFD022FP4EA-52S, VFD037FP4EA-52, VFD037FP4EA-52S, VFD040FP4EA-52, VFD040FP4EA-52S, VFD055FP4EA-52, VFD055FP4EA-52S, VFD075FP4EA-52, VFD075FP4EA-52S

1. Press the hook in the top of digital keypad, then rotate to remove the digital keypad (refer to Figure 2)
2. Screw 1~4 torque: 14~16kg-cm [12.2~13.9lb-in.]
3. Loosen the screws 8~13 then remove the fan kit.(refer to Figure 3)
4. Screw 8~12 torque: 6~8kg-cm [5.2~6.9lb-in.]; Screw 13 torque: 12~14kg-cm [10.4~12.2lb-in.]

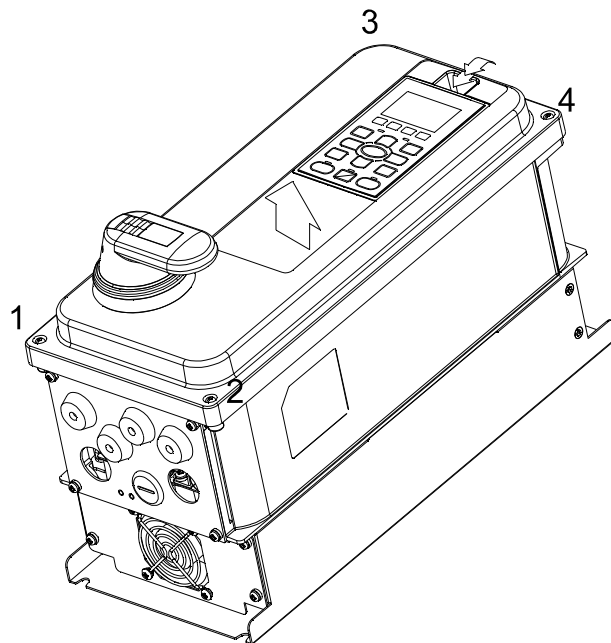

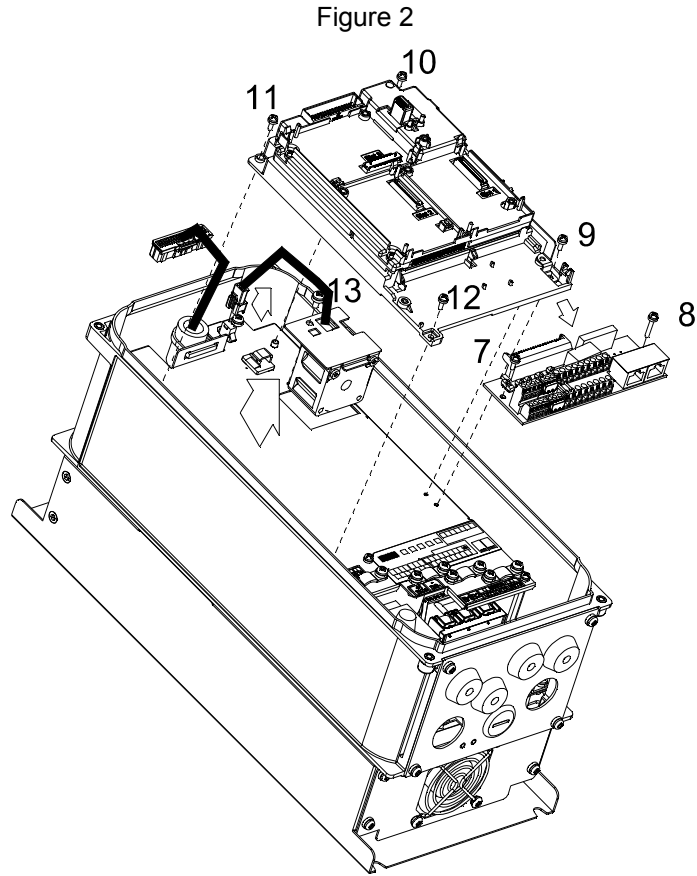

Figure 3

Frame B

Model 『MKFP-BFKM1』 Heat Sink Fan

Applicable model

VFD110FP4EA-52, VFD110FP4EA-52S, VFD150FP4EA-52, VFD150FP4EA-52S, VFD185FP4EA-52, VFD185FP4EA-52S

1. Refer to Figure 1, loosen the 4 screws then remove the fan kit.
2. Screw torque: 14~16kg-cm [12.2~13.9lb-in.]

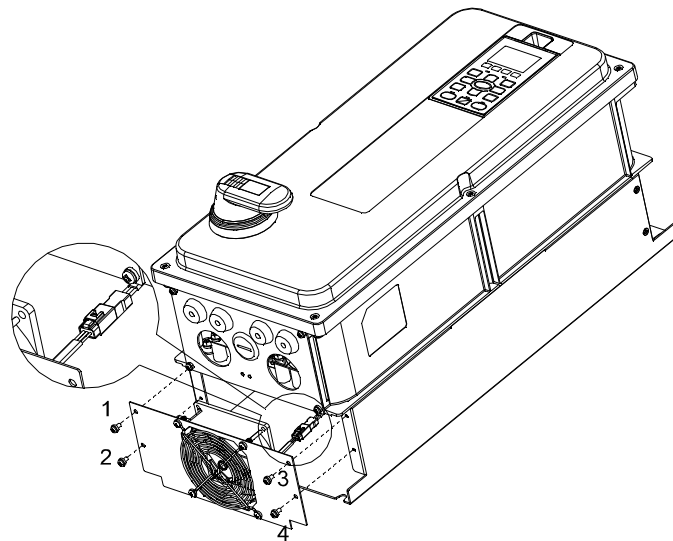

Figure 1

Frame B

Model 『MKFP-BFKB』 Capacitor Fan

Applicable model

VFD110FP4EA-52, VFD110FP4EA-52S, VFD150FP4EA-52, VFD150FP4EA-52S, VFD185FP4EA-52, VFD185FP4EA-52S, VFD220FP4EA-52, VFD220FP4EA-52S

1. Press the hook in the top of digital keypad, then rotate to remove the digital keypad (refer to Figure 2)
2. Screw 1~6 torque: 14~16kg-cm [12.2~13.9lb-in.]
3. Loosen the screws 8~13 then remove the fan kit.(refer to Figure 3)
4. Screw 8~12 torque: 6~8kg-cm [5.2~6.9lb-in.]; Screw 13 torque: 12~14kg-cm [10.4~12.2lb-in.]

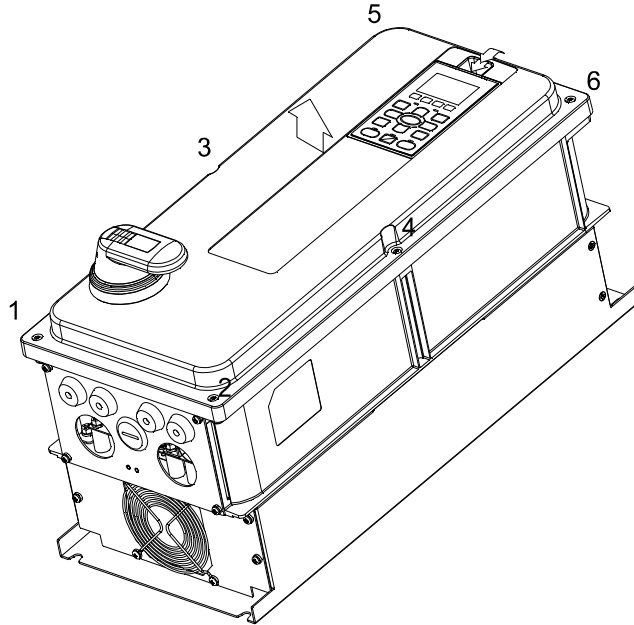

Figure 2

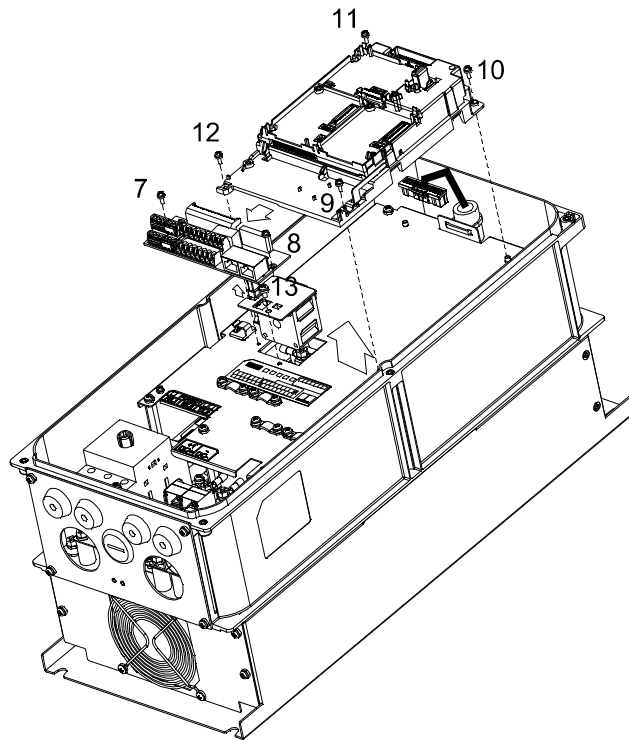

Figure 3

Frame C

Model 『MKFP-CFKM』 Heat Sink Fan

Applicable model

VFD300FP4EA-52, VFD370FP4EA-52; VFD300FP4EA-52S, VFD370FP4EA-52S

1. Refer to Figure 1, loosen the 4 screws then remove the fan kit.
2. Screw torque: 24~26kg-cm [20.8~22.6lb-in.]

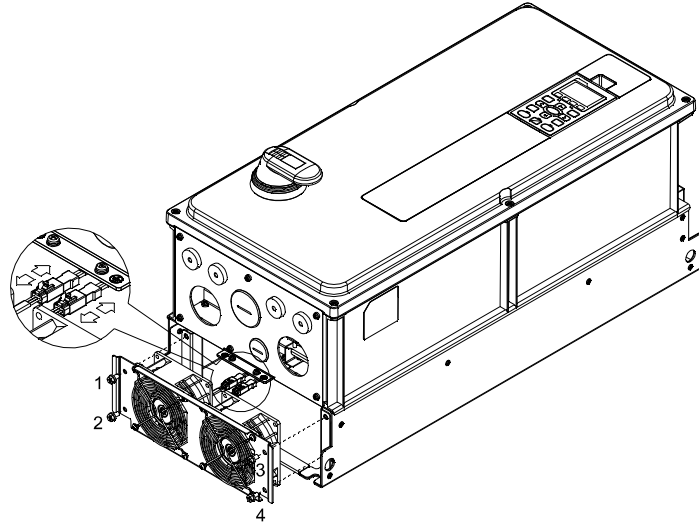

Figure 1

Frame C

Model 『MKFP-CFKB2』 Capacitor Fan

Applicable model

VFD300FP4EA-52, VFD370FP4EA-52; VFD300FP4EA-52S, VFD370FP4EA-52S

1. Press the hook in the top of digital keypad, then rotate to remove the digital keypad (refer to Figure 2)
2. Screw 1~6 torque: 14~16kg-cm [12.1~13.9lb-in.]
3. Loosen the screw 7 then remove the fan kit.(refer to Figure 3)
4. Screw 7 torque: 12~15kg-cm [10.4~13lb-in.]

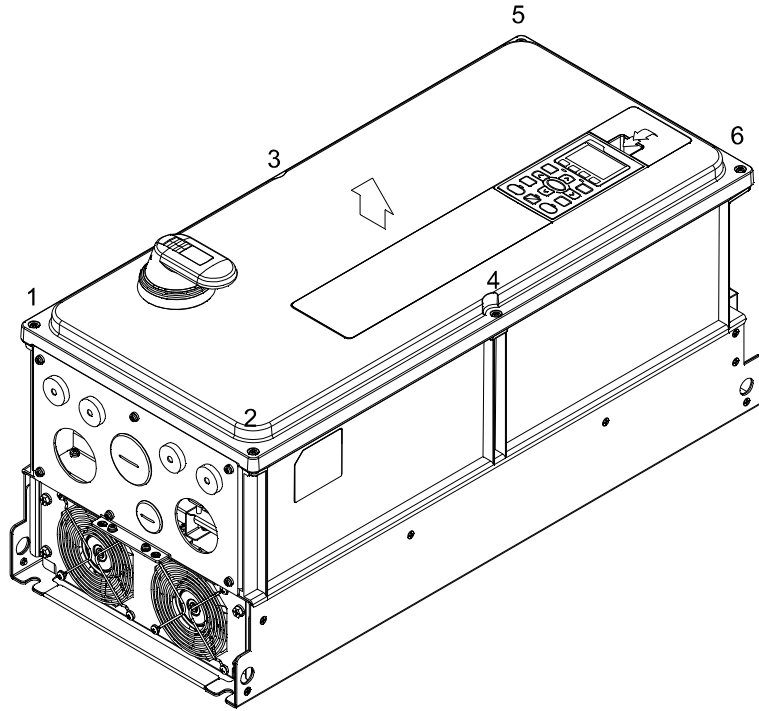

Figure 2

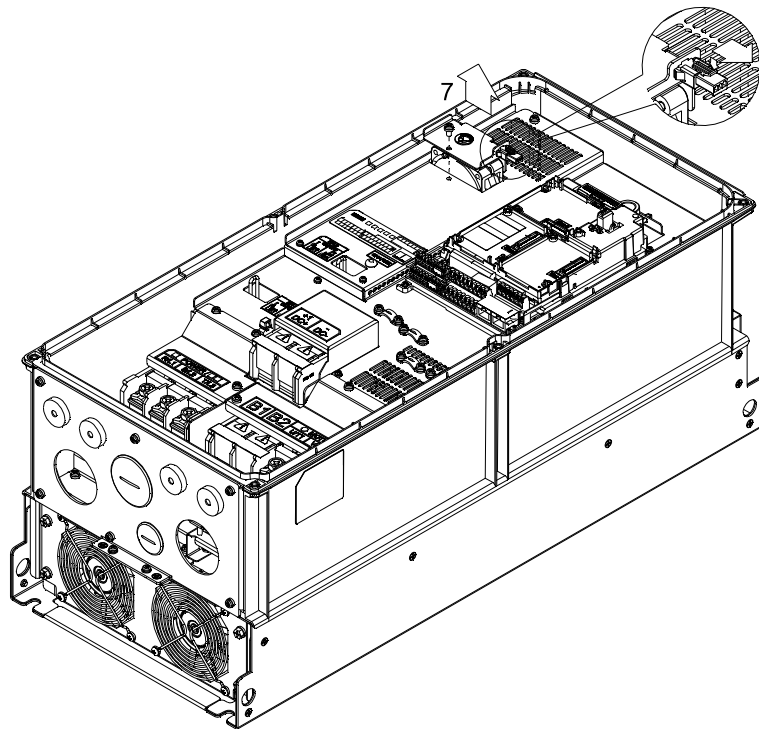

Figure 3

Frame D0

Model 『MKFP-D0FKM』 Heat Sink Fan

Applicable model

VFD450FP4EA-52, VFD550FP4EA-52; VFD450FP4EA-52S, VFD550FP4EA-52S

1. Loosen the screw and remove the fan kit. 『Screw torque: 24~26kgf-cm (20.8~22.6lb-in)』
2. Before removing the fan, remove the cover by using a slotted screwdriver. (refer to Figure 1)

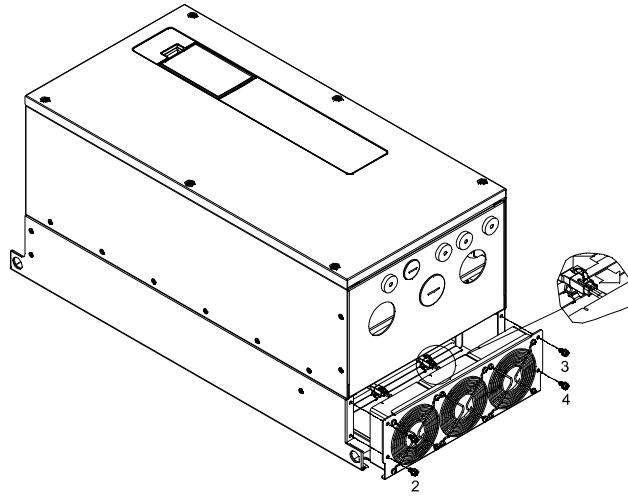

Figure 1

Frame D0

Model 『MKFP-DFKB』 Capacitor Fan

Applicable model

VFD450FP4EA-52, VFD550FP4EA-52; VFD450FP4EA-52S, VFD550FP4EA-52S

1. Press the hook in the top of digital keypad, then rotate to remove the digital keypad (refer to Figure 2)
2. Screw 1~6 torque: 14~16kg-cm [12.1~13.9lb-in.]
3. Loosen the screw 7 then remove the fan kit.(refer to Figure 3)
4. Screw 7 torque: 12~15kg-cm [10.4~13lb-in.]

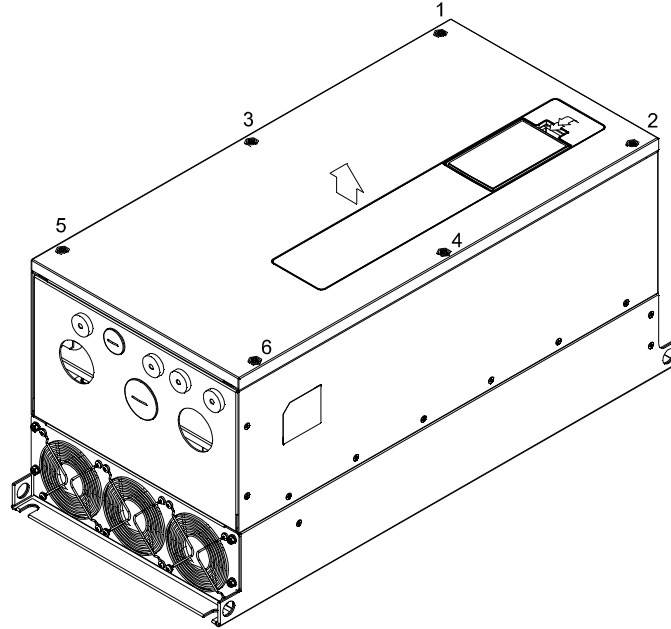

Figure 2

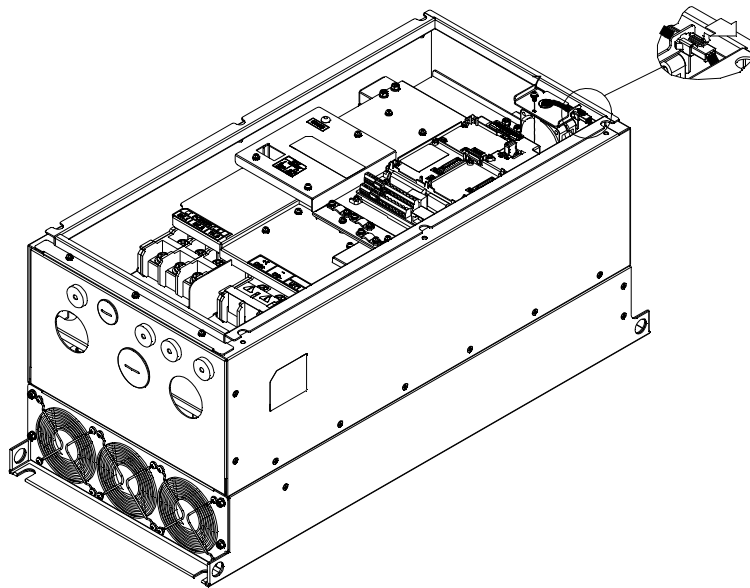

Figure 3

Frame D

Model 『MKFP-DFKM』 Heat Sink Fan

Applicable model

VFD750FP4EA-52, VFD900FP4EA-52; VFD750FP4EA-52S, VFD900FP4EA-52S

1. Loosen the screw and remove the fan kit. Screw torque: 14~16kg-cm [12.1~13.9lb-in.]
2. Before removing the fan, remove the cover by using a slotted screwdriver. (refer to Figure 1)

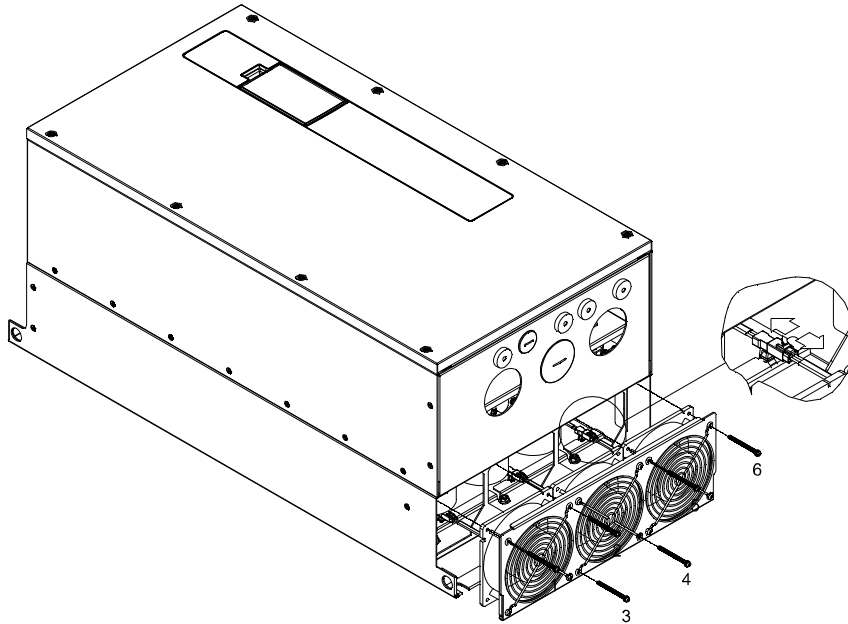

Figure 1

Frame D

Model 『MKFP-DFKB』 Capacitor Fan

Applicable model

VFD750FP4EA-52, VFD900FP4EA-52; VFD750FP4EA-52S, VFD900FP4EA-52S

1. Press the hook in the top of digital keypad, then rotate to remove the digital keypad (refer to Figure 2)
2. Screw 1~8 torque: 14~16kg-cm [12.1~13.9lb-in.]
3. Loosen the screw 9 then remove the fan kit.(refer to Figure 3)
4. Screw 9 torque: 12~15kg-cm [10.4~13lb-in.]

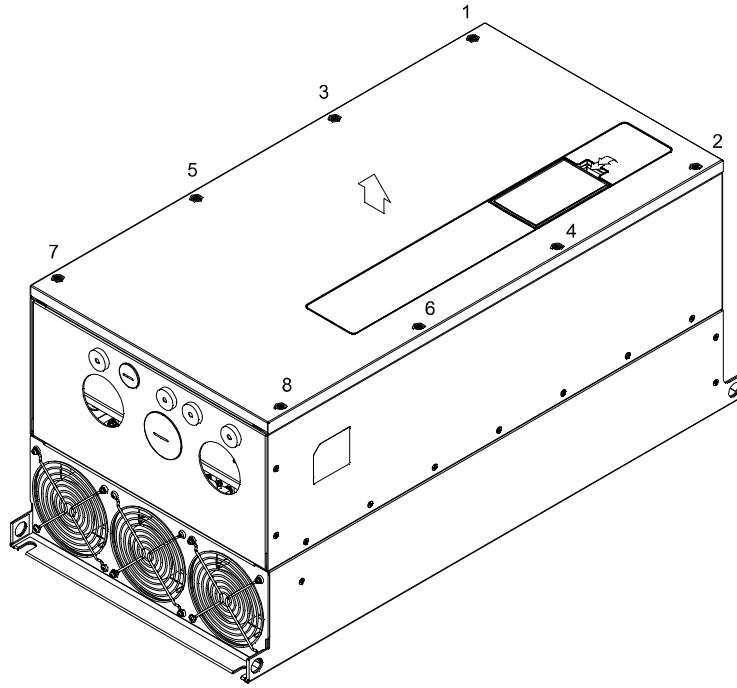

Figure 2

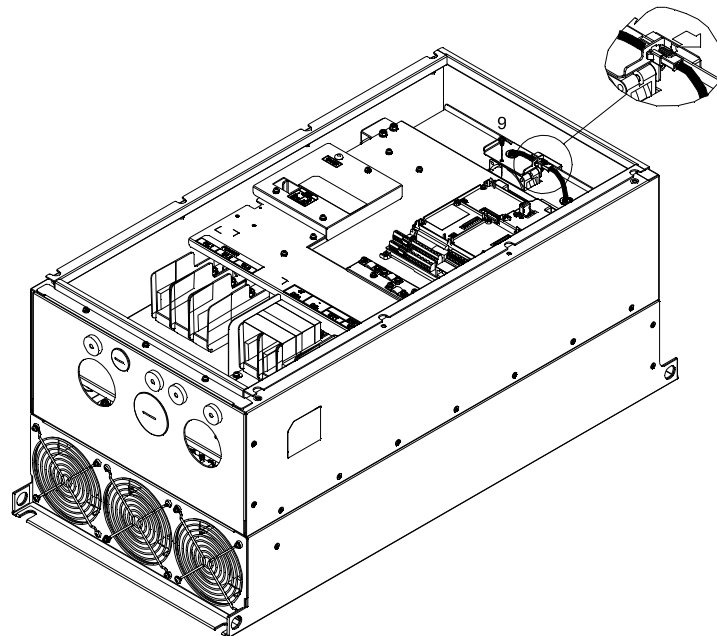

Figure 3

7-9 USB/RS-485 Communication Interface IFD6530

Warning

- ✓ Please thoroughly read this instruction sheet before installation and putting it into use.
- ✓ The content of this instruction sheet and the driver file may be revised without prior notice. Please consult our distributors or download the most updated instruction/driver version at http://www.delta.com.tw/product/em/control/cm/control_cm_main.asp

1. Introduction

IFD6530 is a convenient RS-485-to-USB converter, which does not require external power-supply and complex setting process. It supports baud rate from 75 to 115.2kbps and auto switching direction of data transmission. In addition, it adopts RJ-45 in RS-485 connector for users to wire conveniently. And its tiny dimension, handy use of plug-and-play and hot-swap provide more conveniences for connecting all DELTA IABU products to your PC.

Applicable Models: All DELTA IABU products.

(Application & Dimension)

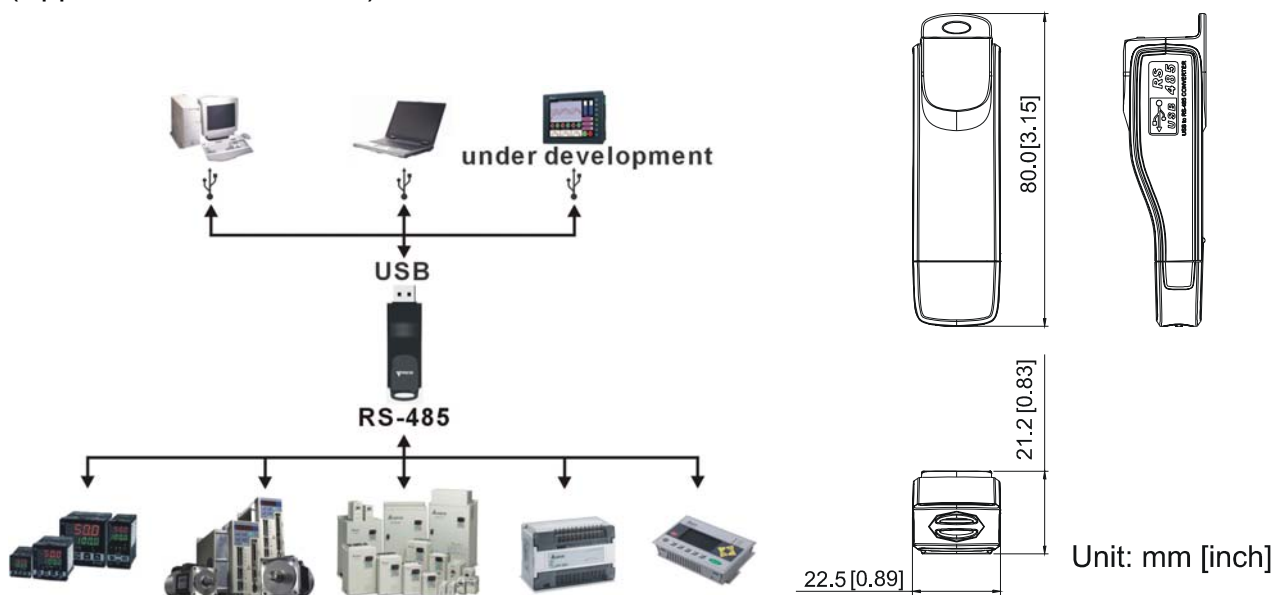

2. Specifications

Power supply	No external power is needed
Power consumption	1.5W
Isolated voltage	2,500VDC
Baud rate	75, 150, 300, 600, 1,200, 2,400, 4,800, 9,600, 19,200, 38,400, 57,600, 115,200 bps
RS-485 connector	RJ-45
USB connector	A type (plug)
Compatibility	Full compliance with USB V2.0 specification
Max. cable length	RS-485 Communication Port: 100 m
Support RS-485 half-duplex transmission	

■ RJ-45

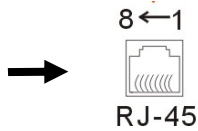

PIN	Description
1	Reserved
2	Reserved
3	GND
4	SG-

PIN	Description
5	SG+
6	GND
7	Reserved
8	+9V

3. Preparations before Driver Installation

Please extract the driver file (IFD6530_Drivers.exe) by following steps. You could find driver file (IFD6530_Drivers.exe) in the CD supplied with IFD6530.

Note: DO NOT connect IFD6530 to PC before extracting the driver file.

STEP 1 **STEP 2**

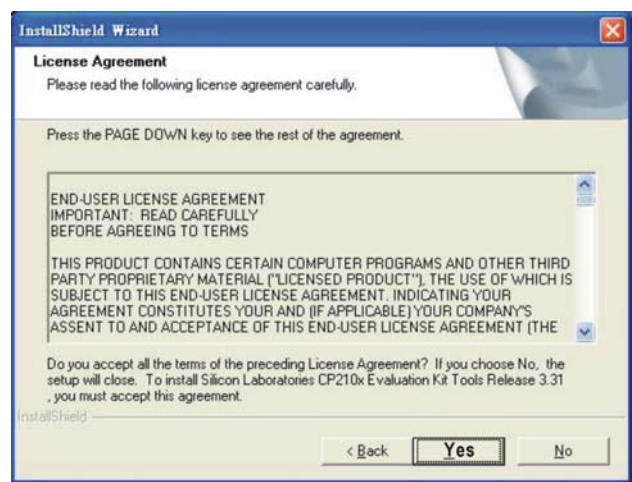
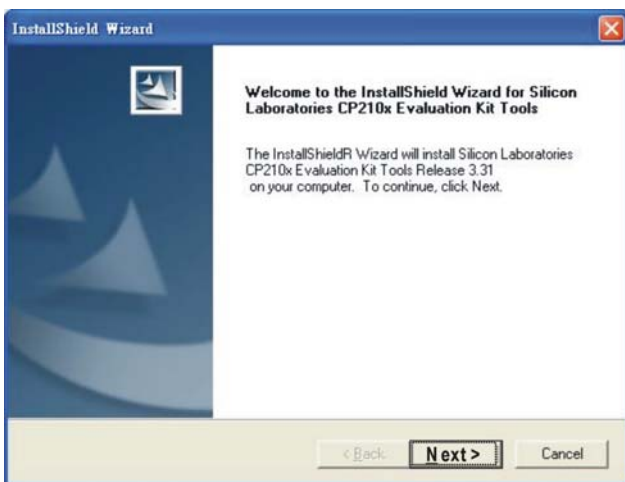

STEP 3 **STEP 4**

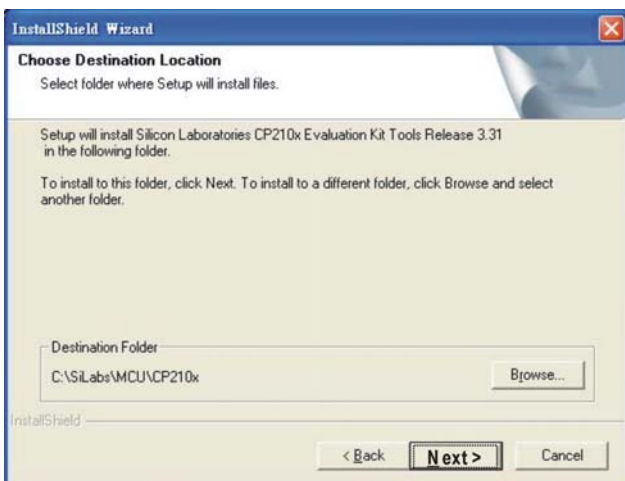

STEP 5

You should have a folder marked SiLabs under drive C. c:\ SiLabs

4. Driver Installation

After connecting IFD6530 to PC, please install driver by following steps.

STEP 1



STEP 2

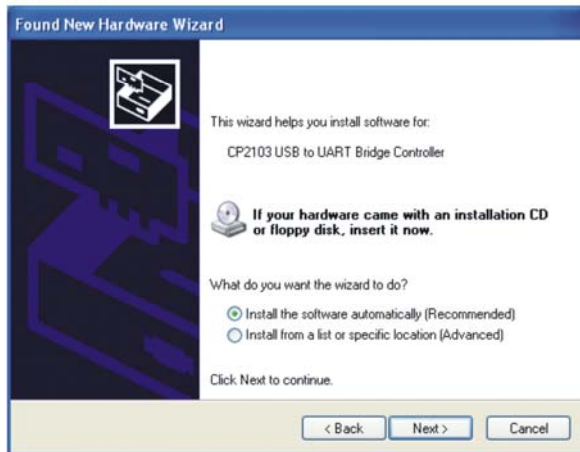

OR

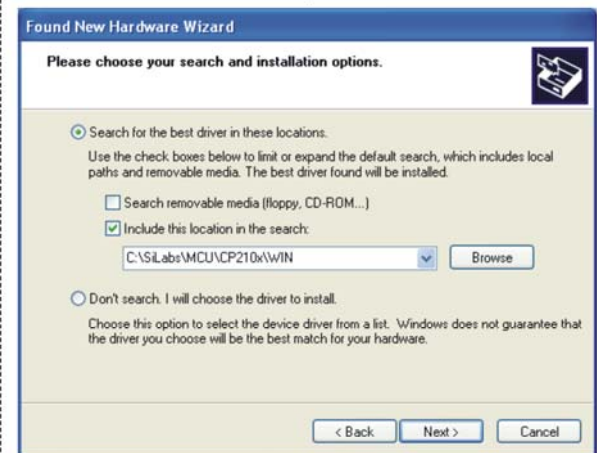
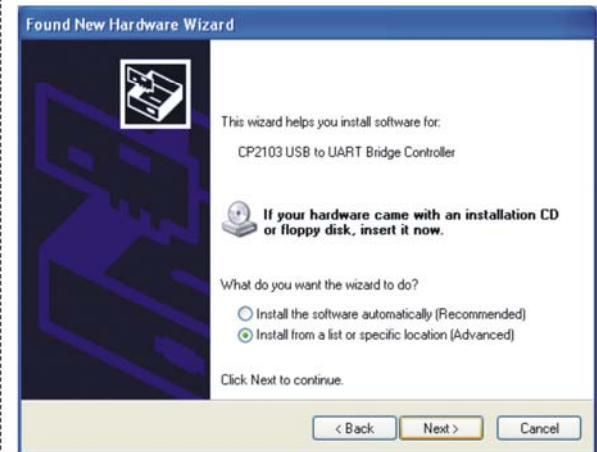

Browse and select directory, or enter
C:\SiLabs\MCU\CP210x\WIN

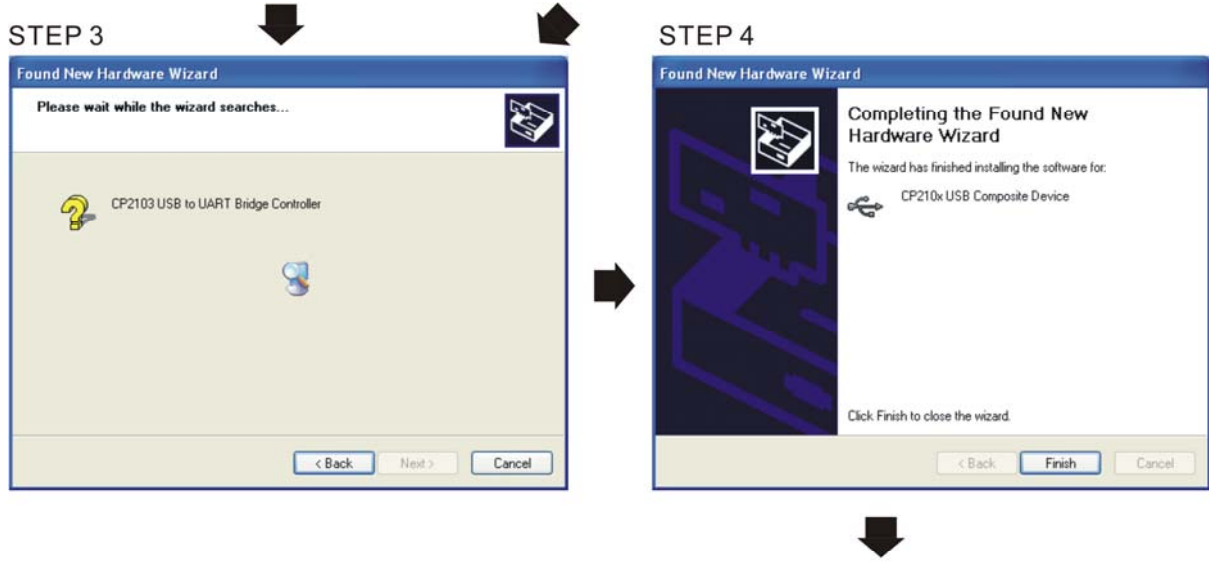

STEP 5
Repeat Step 1 to Step 4 to complete COM PORT setting.

5. LED Display

1. Steady Green LED ON: power is ON.
2. Blinking orange LED: data is transmitting.

Chapter 8 Option Cards

8-1 Removed Key Cover

8-2 Screws Specification for Option Card Terminals

8-3 EMC-D42A

8-4 EMC-D611A

8-5 EMC-R6AA

8-6 EMC-BPS01

8-7 CMC-MOD01

8-8 CMC-PD01

8-9 CMC-DN01

8-10 CMC-EIP01

8-11 EMC-COP01

Please select applicable option cards for your drive or contact local distributor for suggestion. To prevent drive damage during installation, please removes the digital keypad and the cover before wiring. Refer to the following instruction.

8-1 Removed key cover

Frame A&B
Screw Torque: 12~15Kg-cm [10.4~13lb-in.]

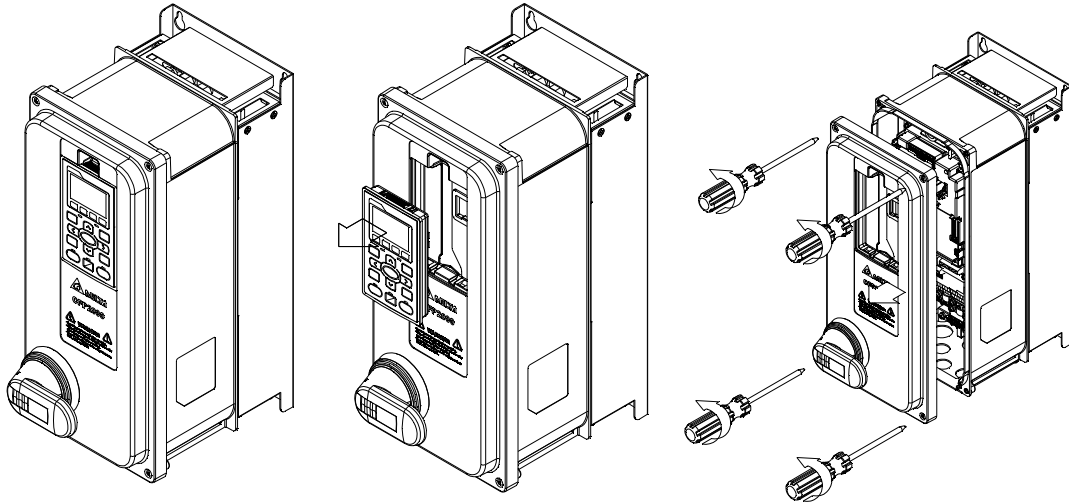

Frame C
Screw Torque: 12~15Kg-cm [10.4~13lb-in.]

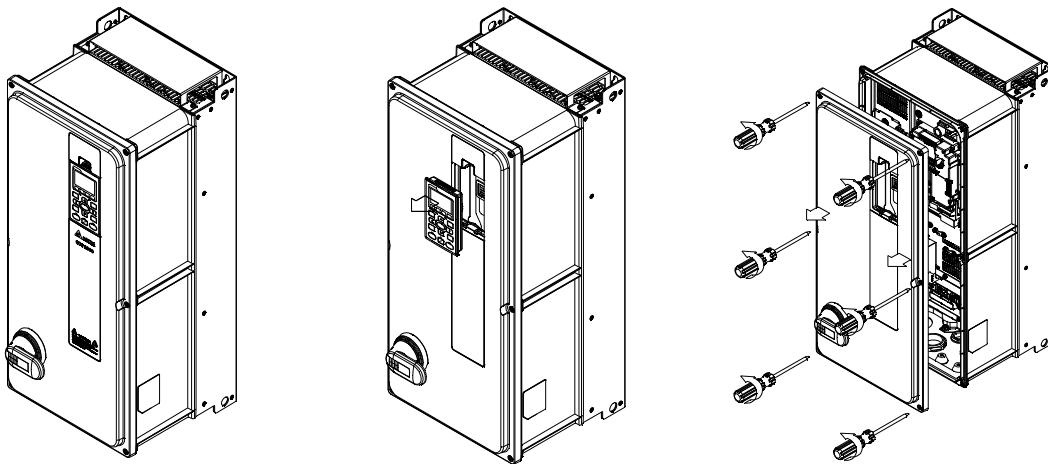

Frame D0~D
Screw Torque: 14~16Kg-cm [12.1~13.9lb-in.]

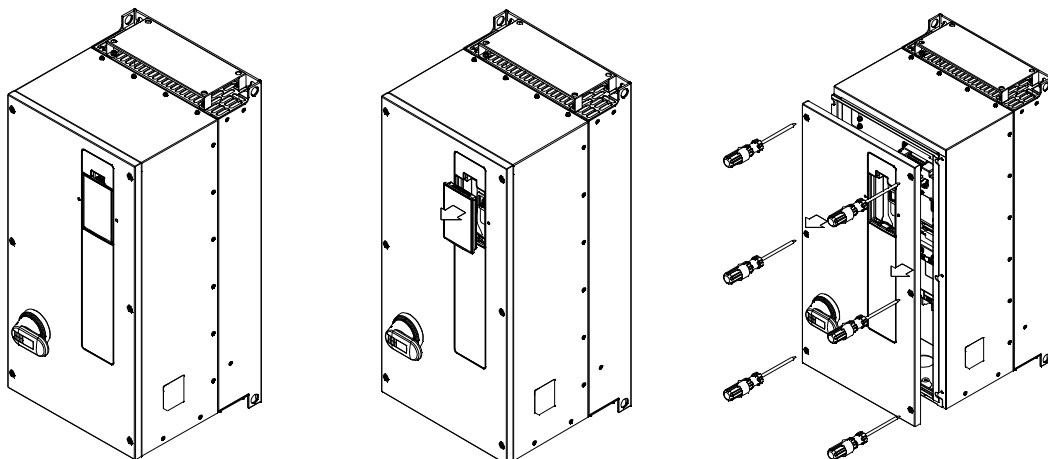

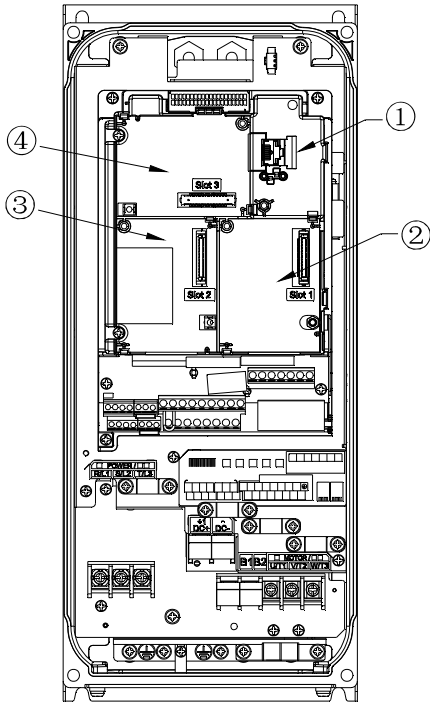

1	<p>RJ45 (Socket) for digital keypad KPC-CC02</p> <p>Please refer to CH10 Digital Keypad for more details on KPC-CC02.</p> <p>Please refer to CH10 Digital Keypad for more details on optional accessory RJ45 extension cable.</p>
2	<p>Communication extension card (Slot 1)</p> <p>CMC-MOD01; CMC-PD01; CMC-DN01; CMC-EIP01; EMC-COP01;</p>
3	<p>PG Card (Slot 2)</p> <p>CFP2000 donot support PG Card.</p>
4	<p>I/O & Relay extension card (Slot 3)</p> <p>EMC-D42A; EMC-D611A; EMC-R6AA; EMC-BPS01;</p>

8-2 Screws Specification for option card terminals:

EMC-D42A EMC-D611A EMC-BPS01	Wire gauge	24~12AWG (0.205~3.31mm ²)
	Torque	5Kg-cm [4.4 lb-in] (0.5Nm)
EMC-R6AA	Wire gauge	26~16AWG (0.128~1.31mm ²)
	Torque	8Kg-cm [7 lb-in] (0.8Nm)

I/O & Relay extension card (Slot 3)

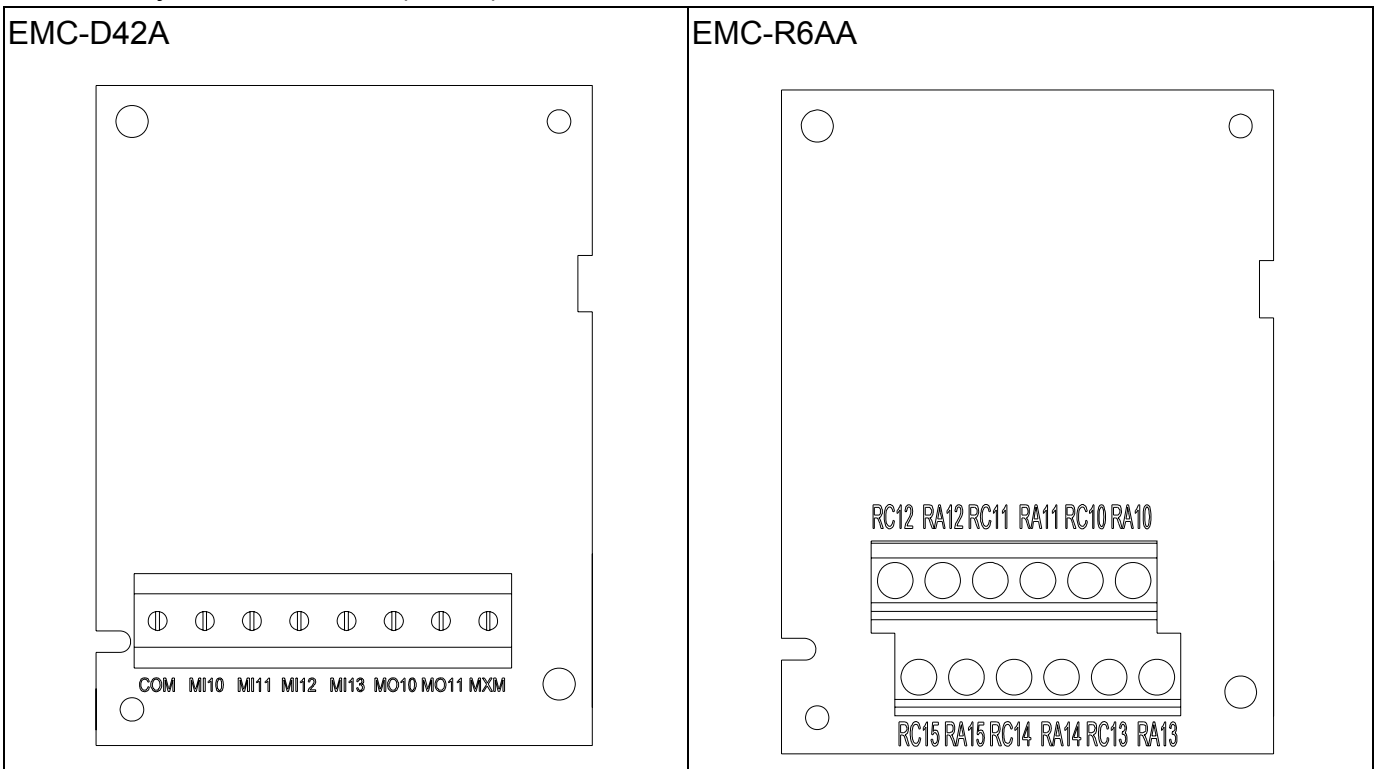

EMC-BPS01

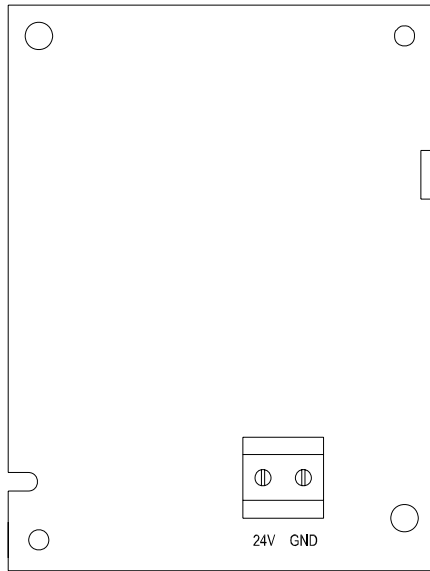

EMC-D611A

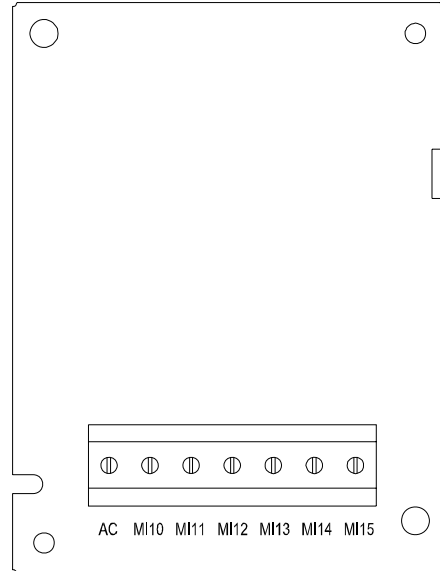

Communication extension card (Slot 1)

CMC-PD01

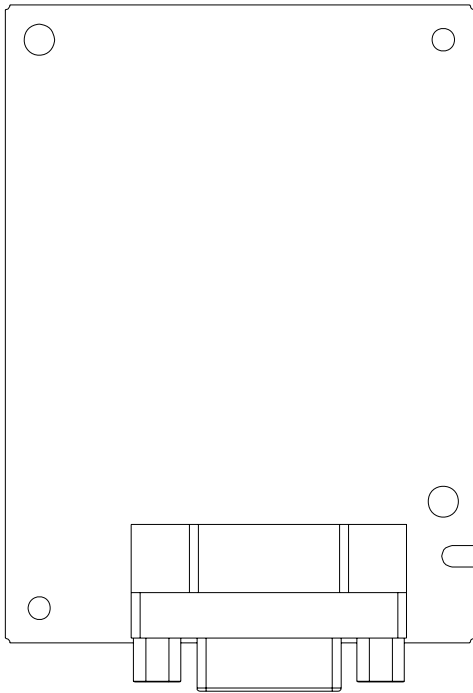

CMC-DN01

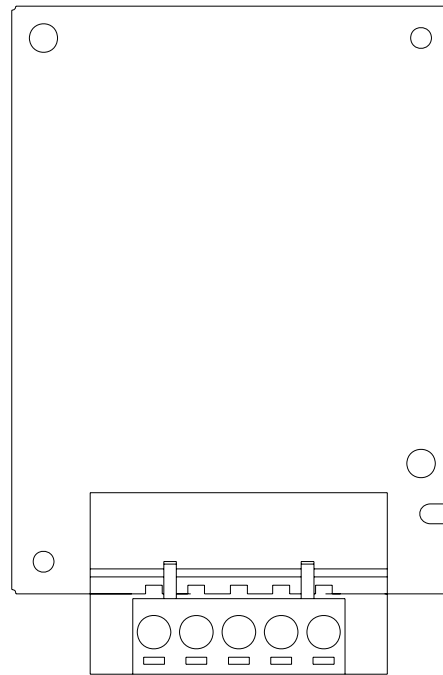

CMC-MOD01/ CMC-EIP01

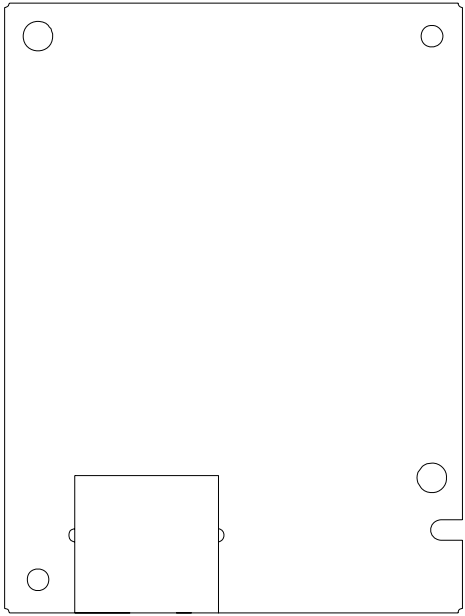

EMC-COP01

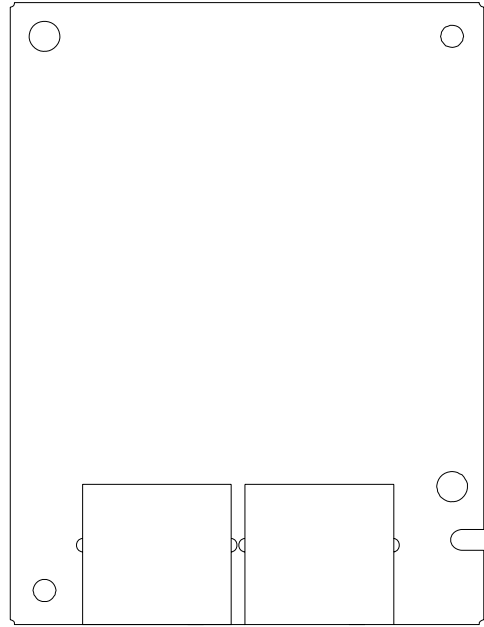

Communication Card installation (I/O & Relay extension card)

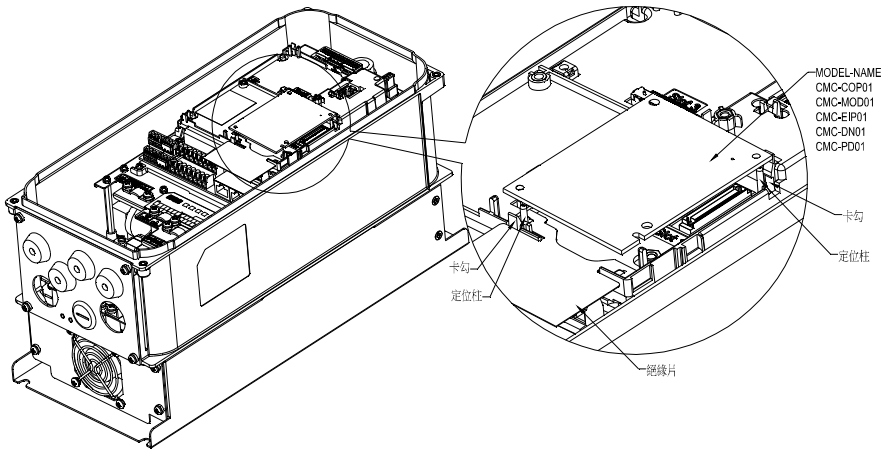

Put the insulating plate on the positioning column first, then align the positioning column by using two holes on the PCB, press it and let two hooks stuck on the PCB as the figure showing.

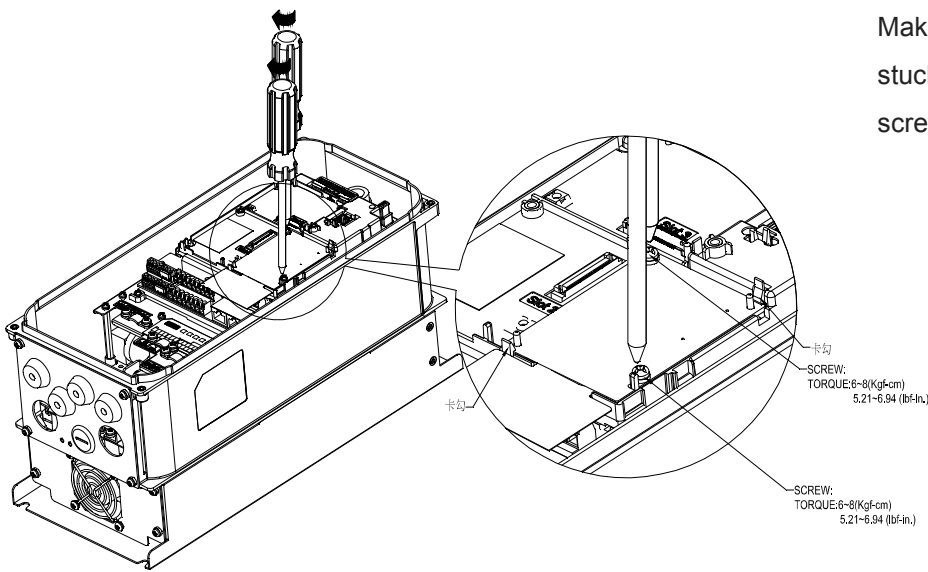

Make sure that the two hooks are stuck on the PCB then lock the screws as the figure showing.

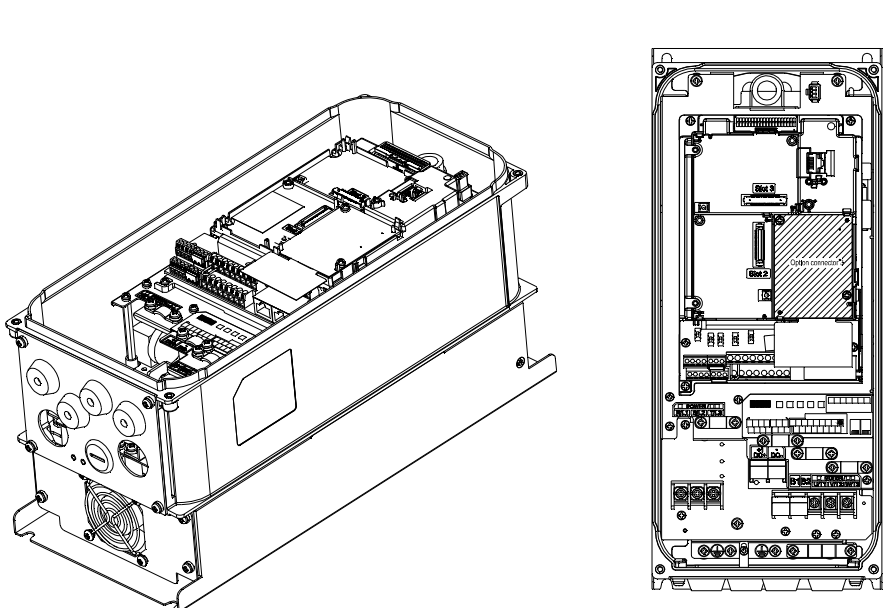

The assembly is completed as the figure showing.

Disconnecting the extension card

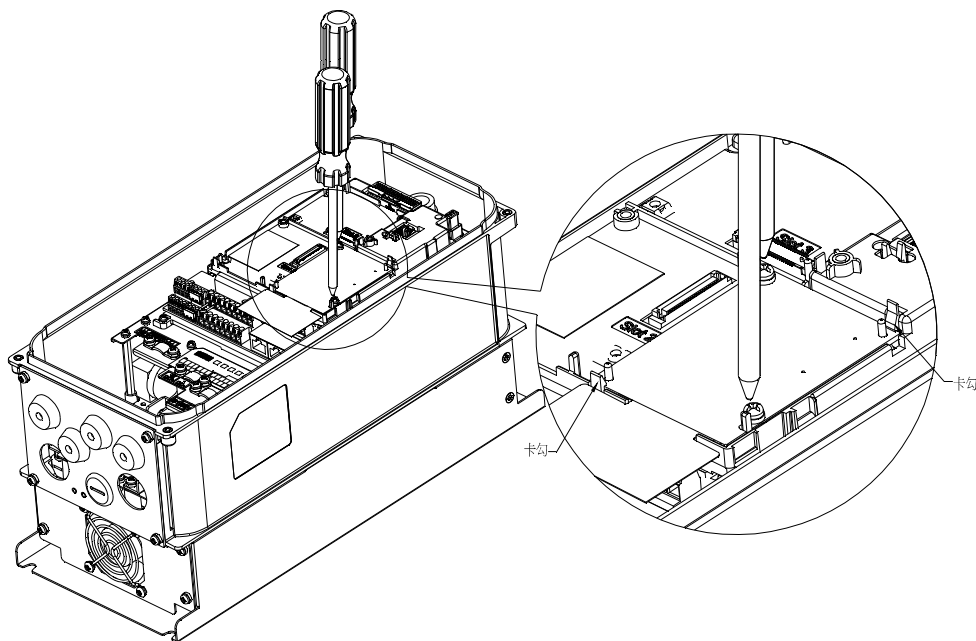

Loosen the two screws as the figure showing.

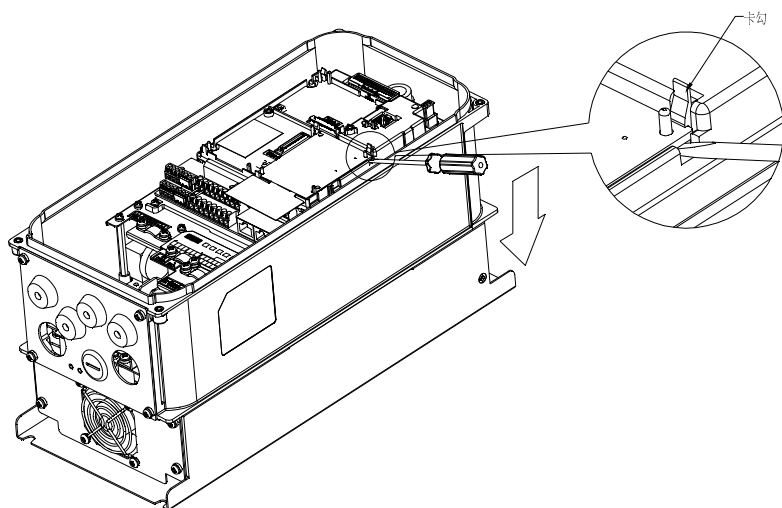

Pull open the hook then put slotted screwdriver into the sag under the PCB, let PCB out of the hook as the figure showing.

8-3 EMC-D42A

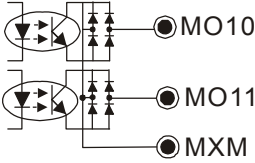
	Terminals	Descriptions
I/O Extension Card	COM	Common for Multi-function input terminals Select SINK(NPN)/SOURCE(PNP)in J1 jumper / external power supply
	MI10~ MI13	Refer to parameters 02-26~02-29 to program the multi-function inputs MI10~MI13. Internal power is applied from terminal E24: +24Vdc±5% 200mA, 5W External power +24VDC: max. voltage 30VDC, min. voltage 19VDC, 30W ON: the activation current is 6.5mA OFF: leakage current tolerance is 10µA
	MO10~MO11	Multi-function output terminals (photocoupler) The AC motor drive releases various monitor signals, such as drive in operation, frequency attained and overload indication, via transistor (open collector). 
	MXM	Common for multi-function output terminals MO10, MO11(photocoupler) Max 48VDC 50mA

8-4 EMC-D611A

	Terminals	Descriptions
I/O Extension Card	AC	AC power Common for multi-function input terminal (Neutral)
	MI10~ MI15	Refer to Pr. 02.26~ Pr. 02.31 for multi-function input selection Input voltage: 100~130VAC Input frequency: 47~63Hz Input impedance: 27Kohm Terminal response time: ON: 10ms OFF: 20ms

8-5 EMC-R6AA

	Terminals	Descriptions
Relay Extension Card	R10A~R15A R10C~R15C	Refer to Pr. 02.36~ Pr. 02.41 for multi-function input selection Resistive load: 5A(N.O.) 250VAC 5A(N.O.) 30VDC Inductive load (COS 0.4) 2.0A(N.O.) 250VAC 2.0A(N.O.) 30VDC It is used to output each monitor signal, such as drive is in operation, frequency attained or overload indication.

8-6 EMC-BPS01

	Terminals	Descriptions
External Power Supply	24V GND	Input power: 24V±5% Maximum input current:0.5A Note: 1) Do not connect control terminal +24V (Digital control signal common: SOURCE) directly to the EMC-BPS01input terminal 24V. 2) Do not connect control terminal GND directly to the EMC-BPS01 input terminal GND.

8-7 CMC-MOD01

■ Features

1. Supports Modbus TCP protocol
2. MDI/MDI-X auto-detect
3. Baud rate: 10/100Mbps auto-detect
4. E-mail alarm
5. AC motor drive keypad/Ethernet configuration
6. Virtual serial port.

■ Product File

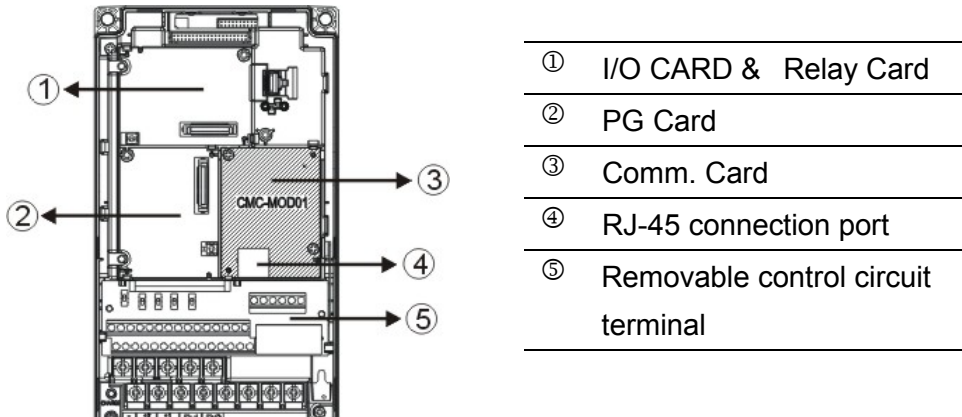

■ Specifications

Network Interface

Interface	RJ-45 with Auto MDI/MDIX
Number of ports	1 Port
Transmission method	IEEE 802.3, IEEE 802.3u
Transmission cable	Category 5e shielding 100M
Transmission speed	10/100 Mbps Auto-Detect
Network protocol	ICMP, IP, TCP, UDP, DHCP, HTTP, SMTP, MODBUS OVER TCP/IP, Delta Configuration

Electrical Specification

Power supply voltage	5VDC (supply by the AC motor drive)
Insulation voltage	500Vdc
Power consumption	0.8W
Weight	25g

Environment

Noise immunity	ESD (IEC 61800-5-1, IEC 61000-4-2) EFT (IEC 61800-5-1, IEC 61000-4-4) Surge Test (IEC 61800-5-1, IEC 61000-4-5) Conducted Susceptibility Test (IEC 61800-5-1, IEC 61000-4-6)
Operation/storage	Operation: -10°C ~ 50°C (temperature), 90% (humidity) Storage: -25°C ~ 70°C (temperature), 95% (humidity)
Vibration/shock immunity	International standard: IEC 61800-5-1, IEC 60068-2-6/IEC 61800-5-1, IEC 60068-2-27

■ Communication Parameters for VFD-CFP2000 Connected to Ethernet

When VFD-CFP2000 is linking to Ethernet, please set up the communication parameters base on the table below. Ethernet master will be able to read/write the frequency word and control word of VFD-CFP2000 after communication parameters setup.

Parameter	Function	Set value (Dec)	Explanation
P00-20	Source of frequency command setting	8	The frequency command is controlled by communication card.
P00-21	Source of operation command setting	5	The operation command is controlled by communication card.
P09-30	Decoding method for communication	0	Decoding method for Delta AC motor drive
P09-75	IP setting	0	Static IP(0) / Dynamic distribution IP(1)
P09-76	IP address -1	192	IP address 192.168.1.5
P09-77	IP address -2	168	IP address 192.168.1.5
P09-78	IP address -3	1	IP address 192.168.1.5
P09-79	IP address -4	5	IP address 192.168.1.5
P09-80	Netmask -1	255	Netmask 255.255.255.0
P09-81	Netmask -2	255	Netmask 255.255.255.0
P09-82	Netmask -3	255	Netmask 255.255.255.0
P09-83	Netmask -4	0	Netmask 255.255.255.0
P09-84	Default gateway -1	192	Default gateway 192.168.1.1
P09-85	Default gateway -2	168	Default gateway 192.168.1.1
P09-86	Default gateway -3	1	Default gateway 192.168.1.1
P09-87	Default gateway -4	1	Default gateway 192.168.1.1

■ Basic Registers

BR#	R/W	Content	Explanation
#0	R	Model name	Set up by the system; read only. The model code of CMC-MOD01=H'0203
#1	R	Firmware version	Displaying the current firmware version in hex, e.g. H'0100 indicates the firmware version V1.00.
#2	R	Release date of the version	Displaying the data in decimal form. 10,000s digit and 1,000s digit are for "month"; 100s digit and 10s digit are for "day". For 1 digit: 0 = morning; 1 = afternoon.
#11	R/W	Modbus Timeout	Pre-defined setting: 500 (ms)
#13	R/W	Keep Alive Time	Pre-defined setting: 30 (s)

■ LED Indicator & Troubleshooting

LED Indicators

LED	Status		Indication	How to correct it?
POWER	Green	On	Power supply in normal status	--
		Off	No power supply	Check the power supply
LINK	Green	On	Network connection in normal status	--
		Flashes	Network in operation	--
		Off	Network not connected	Check if the network cable is connected

Troubleshooting

Abnormality	Cause	How to correct it?
POWER LED off	AC motor drive not powered	Check if AC motor drive is powered, and if the power supply is normal.
	CMC-MOD01 not connected to AC motor drive	Make sure CMC-MOD01 is connected to AC motor drive.
LINK LED off	CMC-MOD01 not connected to network	Make sure the network cable is correctly connected to network.
	Poor contact to RJ-45 connector	Make sure RJ-45 connector is connected to Ethernet port.
No module found	CMC-MOD01 not connected to network	Make sure CMC-MOD01 is connected to network.
	PC and CMC-MOD01 in different networks and blocked by network firewall.	Search by IP or set up relevant settings by AC motor drive keypad.
Fail to open CMC-MOD01 setup page	CMC-MOD01 not connected to network	Make sure CMC-MOD01 is connected to the network.
	Incorrect communication setting in DCISoft	Make sure the communication setting in DCISoft is set to Ethernet.
	PC and CMC-MOD01 in different networks and blocked by network firewall.	Conduct the setup by AC motor drive keypad.
Able to open CMC-MOD01 setup page but fail to utilize webpage monitoring	Incorrect network setting in CMC-MOD01	Check if the network setting for CMC-MOD01 is correct. For the Intranet setting in your company, please consult your IT staff. For the Internet setting in your home, please refer to the network setting instruction provided by your ISP.
Fail to send e-mail	Incorrect network setting in CMC-MOD01	Check if the network setting for CMC-MOD01 is correct.
	Incorrect mail server setting	Please confirm the IP address for SMTP-Server.

8-8 CMC-PD01

■ Features

1. Supports PZD control data exchange.
2. Supports PKW polling AC motor drive parameters.
3. Supports user diagnosis function.
4. Auto-detects baud rates; supports Max. 12Mbps.

■ Product Profile

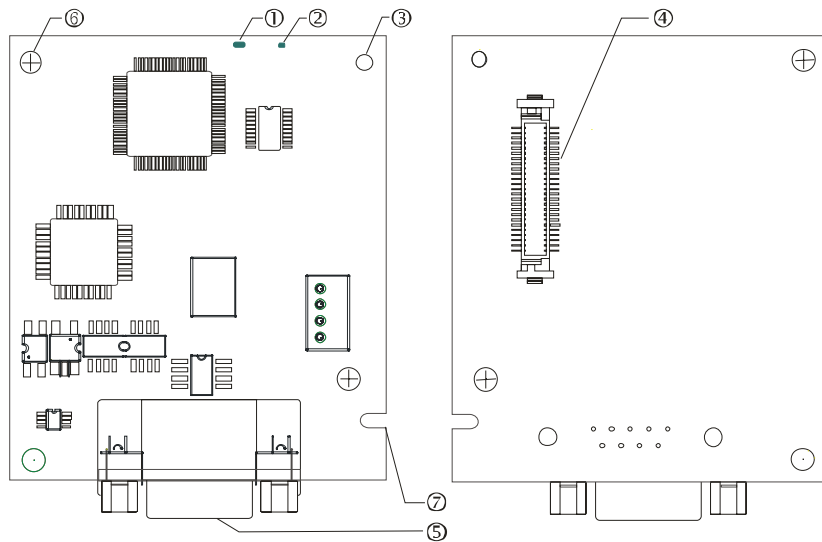

1. NET indicator
2. POWER indicator
3. Positioning hole
4. AC motor drive connection port
5. PROFIBUS DP connection port
6. Screw fixing hole
7. Fool-proof groove

■ Specifications

PROFIBUS DP Connector

Interface	DB9 connector
Transmission method	High-speed RS-485
Transmission cable	Shielded twisted pair cable
Electrical isolation	500VDC

Communication

Message type	Cyclic data exchange
Module name	CMC-PD01
GSD document	DELA08DB.GSD
Company ID	08DB (HEX)
Serial transmission speed supported (auto-detection)	9.6kbps; 19.2kbps; 93.75kbps; 187.5kbps; 125kbps; 250kbps; 500kbps; 1.5Mbps; 3Mbps; 6Mbps; 12Mbps (bit per second)

Electrical Specification

Power supply	5VDC (supplied by AC motor drive)
Insulation voltage	500VDC
Power consumption	1W
Weight	28g

Environment

Noise immunity	ESD(IEC 61800-5-1,IEC 6100-4-2) EFT(IEC 61800-5-1,IEC 6100-4-4) Surge Teat(IEC 61800-5-1,IEC 6100-4-5) Conducted Susceptibility Test(IEC 61800-5-1,IEC 6100-4-6)
Operation /storage	Operation: -10°C ~ 50°C (temperature), 90% (humidity) Storage: -25°C ~ 70°C (temperature), 95% (humidity)
Shock / vibration resistance	International standards: IEC61131-2, IEC68-2-6 (TEST Fc)/IEC61131-2 & IEC 68-2-27 (TEST Ea)

■ Installation

PROFIBUS DP Connector

PIN	PIN name	Definition
1	-	Not defined
2	-	Not defined
3	Rxd/Txd-P	Sending/receiving data P(B)
4	-	Not defined
5	DGND	Data reference ground
6	VP	Power voltage – positive
7	-	Not defined
8	Rxd/Txd-N	Sending/receiving data N(A)
9	-	Not defined

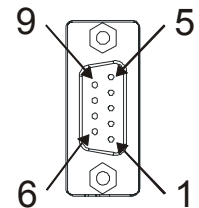

■ LED Indicator & Troubleshooting

There are 2 LED indicators on CMC-PD01. POWER LED displays the status of the working power. NET LED displays the connection status of the communication.

POWER LED

LED status	Indication	How to correct it?
Green light on	Power supply in normal status.	--
Off	No power	Check if the connection between CMC-PD01 and AC motor drive is normal.

NET LED

LED status	Indication	How to correct it?
Green light on	Normal status	--
Red light on	CMC-PD01 is not connected to PROFIBUS DP bus.	Connect CMC-PD01 to PROFIBUS DP bus.
Red light flashes	Invalid PROFIBUS communication address	Set the PROFIBUS address of CMC-PD01 between 1 ~ 125 (decimal)
Orange light flashes	CMC-PD01 fails to communication with AC motor drive.	Switch off the power and check whether CMC-PD01 is correctly and normally connected to AC motor drive.

8-9 CMC-DN01

■ Functions

1. Based on the high-speed communication interface of Delta HSSP protocol, able to conduct immediate control to AC motor drive.
2. Supports Group 2 only connection and polling I/O data exchange.
3. For I/O mapping, supports Max. 32 words of input and 32 words of output.
4. Supports EDS file configuration in DeviceNet configuration software.
5. Supports all baud rates on DeviceNet bus: 125kbps, 250kbps, 500kbps and extendable serial transmission speed mode.
6. Node address and serial transmission speed can be set up on AC motor drive.
7. Power supplied from AC motor drive.

■ Product Profile

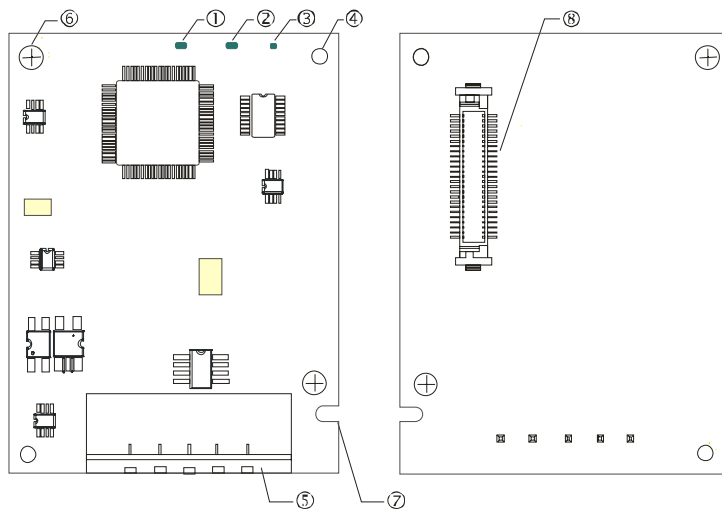

1. NS indicator
2. MS indicator
3. POWER indicator
4. Positioning hole
5. DeviceNet connection port
6. Screw fixing hole
7. Fool-proof groove
8. AC motor drive connection port

■ Specifications

DeviceNet Connector

Interface	5-PIN open removable connector. Of 5.08mm PIN interval
Transmission	CAN
Transmission cable	Shielded twisted pair cable (with 2 power cables)
Transmission speed	125kbps, 250kbps, 500kbps and extendable serial transmission speed
Network protocol	DeviceNet protocol

AC Motor Drive Connection Port

Interface	50 PIN communication terminal
Transmission method	SPI communication
Terminal function	1. Communicating with AC motor drive 2. Transmitting power supply from AC motor drive
Communication	Delta HSSP protocol

Electrical Specification

Power supply voltage	5VDC (supplied by AC motor drive)
Insulation voltage	500VDC
Communication wire power consumption	0.85W
Power consumption	1W
Weight	23g

Environment

Noise immunity	ESD (IEC 61800-5-1,IEC 6100-4-2) EFT (IEC 61800-5-1,IEC 6100-4-4) Surge Teat(IEC 61800-5-1,IEC 6100-4-5) Conducted Susceptibility Test (IEC 61800-5-1,IEC 6100-4-6)
Operation /storage	Operation: -10°C ~ 50°C (temperature), 90% (humidity) Storage: -25°C ~ 70°C (temperature), 95% (humidity)
Shock / vibration resistance	International standards: IEC61131-2, IEC68-2-6 (TEST Fc)/IEC61131-2 & IEC 68-2-27 (TEST Ea)

DeviceNet Connector

PIN	Signal	Color	Definition
1	V+	Red	DC24V
2	H	White	Signal+
3	S	-	Earth
4	L	Blue	Signal-
5	V-	Black	0V

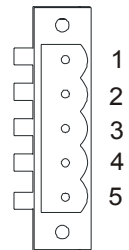

■ LED Indicator & Troubleshooting

There are 3 LED indicators on CMC-DN01. POWER LED displays the status of power supply. MS LED and NS LED are dual-color LED, displaying the connection status of the communication and error messages.

POWER LED

LED status	Indication	How to correct it?
On	Power supply in abnormal status.	Check the power supply of CMC-DN01.
Off	Power supply in normal status	--

NS LED

LED status	Indication	How to correct it?
Off	No power supply or CMC-DN01 has not completed MAC ID test yet.	<ol style="list-style-type: none"> 1. Check the power of CMC-DN01 and see if the connection is normal. 2. Make sure at least one or more nodes are on the bus. 3. Check if the serial transmission speed of CMC-DN01 is the same as that of other nodes.
Green light flashes	CMC-DN01 is on-line but has not established connection to the master.	<ol style="list-style-type: none"> 1. Configure CMC-DN01 to the scan list of the master. 2. Re-download the configured data to the master.
Green light on	CMC-DN01 is on-line and is normally connected to the master	--
Red light flashes	CMC-DN01 is on-line, but I/O connection is timed-out.	<ol style="list-style-type: none"> 1. Check if the network connection is normal. 2. Check if the master operates normally.
Red light on	<ol style="list-style-type: none"> 1. The communication is down. 2. MAC ID test failure. 3. No network power supply. 4. CMC-DN01 is off-line. 	<ol style="list-style-type: none"> 1. Make sure all the MAC IDs on the network are not repeated. 2. Check if the network installation is normal. 3. Check if the baud rate of CMC-DN01 is consistent with that of other nodes. 4. Check if the node address of CMC-DN01 is illegal. 5. Check if the network power supply is normal.

MS LED

LED status	Indication	How to correct it?
Off	No power supply or being off-line	Check the power supply of CMC-DN01 and see if the connection is normal.
Green light flashes	Waiting for I/O data	Switch the master PLC to RUN status
Green light on	I/O data are normal	--
Red light flashes	Mapping error	<ol style="list-style-type: none"> 1. Reconfigure CMC-DN01 2. Re-power AC motor drive
Red light on	Hardware error	<ol style="list-style-type: none"> 1. See the error code displayed on AC motor drive. 2. Send back to the factory for repair if necessary.
Orange light flashes	CMC-DN01 is establishing connection with AC motor drive.	If the flashing lasts for a long time, check if CMC-DN01 and AC motor drive are correctly installed and normally connected to each other.

8-10 CMC-EIP01

■ Features

1. Supports Modbus TCP and Ethernet/IP protocol
2. MDI/MDI-X auto-detect
3. Baud rate: 10/100Mbps auto-detect
4. AC motor drive keypad/Ethernet configuration
5. Virtual serial port

■ Product Profile

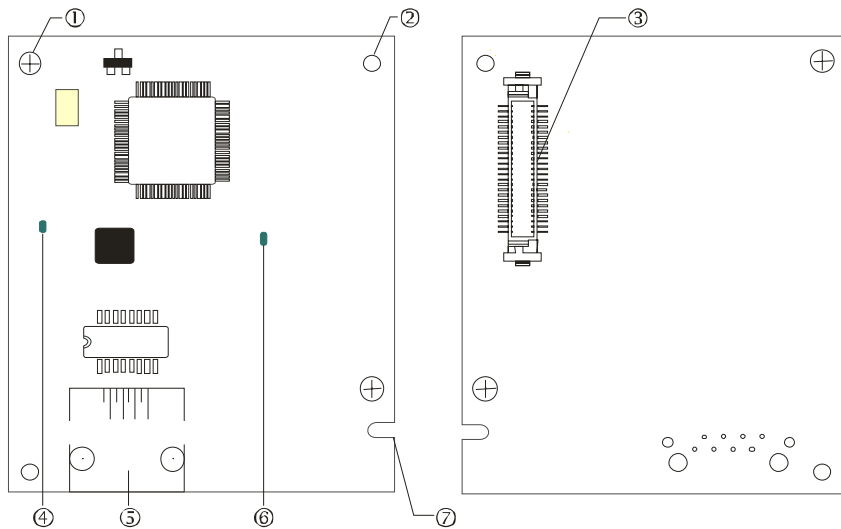

[Figure1]

1. Screw fixing hole
2. Positioning hole
3. AC motor drive connection port
4. LINK indicator
5. RJ-45 connection port
6. POWER indicator
7. Fool-proof groove

■ Specifications

Network Interface

Interface	RJ-45 with Auto MDI/MDIX
Number of ports	1 Port
Transmission method	IEEE 802.3, IEEE 802.3u
Transmission cable	Category 5e shielding 100M
Transmission speed	10/100 Mbps Auto-Detect
Network protocol	ICMP, IP, TCP, UDP, DHCP, HTTP, SMTP, MODBUS OVER TCP/IP, EtherNet/IP, Delta Configuration

Electrical Specification

Weight	25g
Insulation voltage	500VDC
Power consumption	0.8W
Power supply voltage	5VDC

Environment

Noise immunity	ESD (IEC 61800-5-1,IEC 61000-4-2) EFT (IEC 61800-5-1,IEC 61000-4-4) Surge Test (IEC 61800-5-1,IEC 61000-4-5) Conducted Susceptibility Test (IEC 61800-5-1,IEC 61000-4-6)
Operation/storage	Operation: -10°C ~ 50°C (temperature), 90% (humidity) Storage: -25°C ~ 70°C (temperature), 95% (humidity)
Vibration/shock immunity	International standard: IEC 61800-5-1, IEC 60068-2-6/IEC 61800-5-1, IEC 60068-2-27

■ Installation

Connecting CMC-EIP01 to Network

1. Turn off the power of AC motor drive.
2. Open the cover of AC motor drive.
3. Connect CAT-5e network cable to RJ-45 port on CMC-EIP01 (See Figure 2).

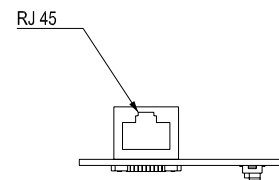

[Figure 2]

RJ-45 PIN Definition

PIN	Signal	Definition	PIN	Signal	Definition
1	Tx+	Positive pole for data transmission	5	--	N/C
2	Tx-	Negative pole for data transmission	6	Rx-	Negative pole for data receiving
3	Rx+	Positive pole for data receiving	7	--	N/C
4	--	N/C	8	--	N/C

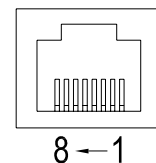

■ Communication Parameters for VFD-CFP2000 Connected to Ethernet

When VFD-CFP2000 is connected to Ethernet network, please set up the communication parameters for it according to the table below. The Ethernet master is only able to read/write the frequency word and control word of VFD-CFP2000 after the communication parameters are set.

Parameter	Function	Set value (Dec)	Explanation
P00-20	Source of frequency command setting	8	The frequency command is controlled by communication card.
P00-21	Source of operation command setting	5	The operation command is controlled by communication card.
P09-30	Decoding method for communication	0	The decoding method for Delta AC motor drive
P09-75	IP setting	0	Static IP(0) / Dynamic distribution IP(1)
P09-76	IP address -1	192	IP address 192.168.1.5
P09-77	IP address -2	168	IP address 192.168.1.5

P09-78	IP address -3	1	IP address 192.168.1.5
P09-79	IP address -4	5	IP address 192.168.1.5
P09-80	Netmask -1	255	Netmask 255.255.255.0
P09-81	Netmask -2	255	Netmask 255.255.255.0
P09-82	Netmask -3	255	Netmask 255.255.255.0
P09-83	Netmask -4	0	Netmask 255.255.255.0
P09-84	Default gateway -1	192	Default gateway 192.168.1.1
P09-85	Default gateway -2	168	Default gateway 192.168.1.1
P09-86	Default gateway -3	1	Default gateway 192.168.1.1
P09-87	Default gateway -4	1	Default gateway 192.168.1.1

■ **LED Indicator & Troubleshooting**

There are 2 LED indicators on CMC-EIP01. The POWER LED displays the status of power supply, and the LINK LED displays the connection status of the communication.

LED Indicators

LED	Status	Indication	How to correct it?	
POWER	Green	On	Power supply in normal status	--
		Off	No power supply	Check the power supply.
LINK	Green	On	Network connection in normal status	--
		Flashes	Network in operation	--
		Off	Network not connected	Check if the network cable is connected.

Troubleshooting

Abnormality	Cause	How to correct it?
POWER LED off	AC motor drive not powered	Check if AC motor drive is powered, and if the power supply is normal.
	CMC-EIP01 not connected to AC motor drive	Make sure CMC-EIP01 is connected to AC motor drive.
LINK LED off	CMC-EIP01 not connected to network	Make sure the network cable is correctly connected to network.
	Poor contact to RJ-45 connector	Make sure RJ-45 connector is connected to Ethernet port.
No communication card found	CMC-EIP01 not connected to network	Make sure CMC-EIP01 is connected to network.
	PC and CMC-EIP01 in different networks and blocked by network firewall.	Search by IP or set up relevant settings by AC motor drive keypad.
Fail to open CMC-EIP01 setup page	CMC-EIP01 not connected to network	Make sure CMC-EIP01 is connected to the network.
	Incorrect communication setting in DCISoft	Make sure the communication setting in DCISoft is set to Ethernet.
	PC and CMC-EIP01 in different networks and blocked by network firewall.	Conduct the setup by AC motor drive keypad.

Abnormality	Cause	How to correct it?
Able to open CMC-EIP01 setup page but fail to utilize webpage monitoring	Incorrect network setting in CMC-EIP01	Check if the network setting for CMC-EIP01 is correct. For the Intranet setting in your company, please consult your IT staff. For the Internet setting in your home, please refer to the network setting instruction provided by your ISP.
Fail to send e-mail	Incorrect network setting in CMC-EIP01	Check if the network setting for CMC-EIP01 is correct.
	Incorrect mail server setting	Please confirm the IP address for SMTP-Server.

8-11 EMC-COP01

RJ-45 Pin definition

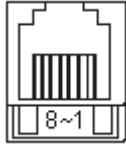

RS485 socket

Pin	Pin name	Definition
1	CAN_H	CAN_H bus line (dominant high)
2	CAN_L	CAN_L bus line (dominant low)
3	CAN_GND	Ground/0V/V-
7	CAN_GND	Ground/0V/V-

Specifications

Interface	RJ-45
Number of ports	1 Port
Transmission method	CAN
Transmission cable	CAN standard cable
Transmission speed	1M 500k 250k 125k 100k 50k
Communication protocol	CANopen

CANopen Communication Cable

Model: TAP-CB03, TAP-CB04

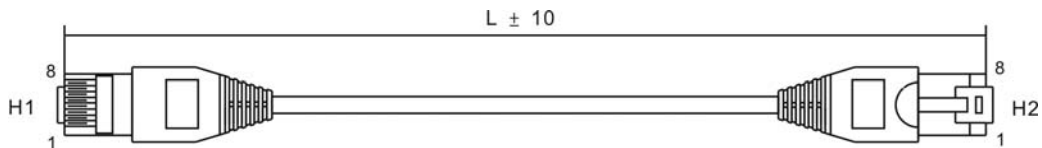

Title	Part No.	L	
		mm	inch
1	TAP-CB03	500 ± 10	19 ± 0.4
2	TAP-CB04	1000 ± 10	39 ± 0.4

CANopen Dimension

Model: TAP-CN03

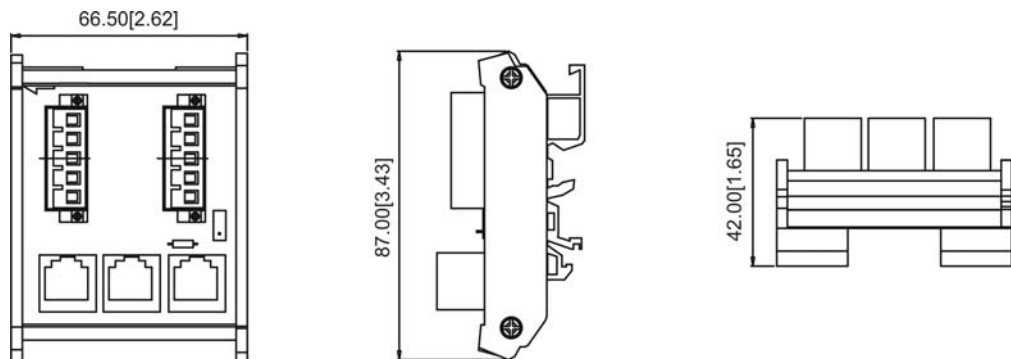

NOTE

For more information on CANopen, please refer to Chapter 15 CANopen Overview or CANopen user manual can also be downloaded on Delta website: <http://www.delta.com.tw/industrialautomation/>.

[The page intentionally left blank]

Chapter 9 Specification

9-1 Specification



Frame Size		A						B					
Model VFD ___ FP4EA- ___		007	015	022	037	040	055	075	110	150	185	220	
Output Rating	Light duty	Rated output capacity (kVA)	2.4	3.3	4.4	6.8	8.4	10.4	14.3	19	25	30	36
		Rated output current (A)	3	4.2	5.5	8.5	10.5	13	18	24	32	38	45
		Applicable motor output (kW)	0.75	1.5	2.2	3.7	4	5.5	7.5	11	15	18.5	22
		Applicable motor output (HP)	1	2	3	5	5	7.5	10	15	20	25	30
	Overload tolerance 120% of rated current can endure for 1 minute during every 5 minutes												
	Normal duty	Max. output frequency (Hz)	1.4	2.4	3.2	4.8	7.2	8.4	10	14	19	25	30
		Carrier frequency (kHz)	2.8	3	4	6	9	10.5	12	18	24	32	38
		Rated output capacity (kVA)	0.4	0.75	1.5	2.2	3.7	4	5.5	7.5	11	15	18.5
Rated output current (A)		0.5	1	2	3	5	5	7.5	10	15	20	25	
Applicable motor output (kW) 120% of rated current can endure for 1 minute during every 5 minutes 160% of rated current can endure for 3 seconds during every 30 seconds.													
Input Rating	Max. output frequency (Hz) 599Hz												
	Carrier frequency (kHz) 2~15 (6kHz)											2~10 (6kHz)	
	Input current (A) Light duty		3.0	4.2	5.5	8.5	10.5	13	18	24	32	38	45
	Input current (A) Normal duty		1.7	3	4	6	9.0	10.5	12	18	24	32	38
	Rated voltage / Frequency 3-phase AC 380V~480V (-15%~+10%), 50/60Hz												
	Operating voltage range 323~528Vac												
	Frequency tolerance 47~63Hz												
	Efficiency (%) >0.98 >0.98 >0.98 >0.98 >0.98 >0.98 >0.98 >0.98 >0.98 >0.98 >0.98 >0.98 >0.98												
Power factor >0.98 >0.98 >0.98 >0.98 >0.98 >0.98 >0.98 >0.98 >0.98 >0.98 >0.98 >0.98 >0.98													
Weight 6.8kg 14.5kg													
Cooling method Natural cooling Fan cooling													
Braking chopper Frame A to C (built-in)													
DC choke Built-in DC reactor EN6100-3-12													
EMC Filter Built-in EMC Filter EN61800-3 C1 & C2													

Frame Size		C		D0		D		
Model VFD ___ FP4EA- ___		300	370	450	550	750	900	
Output Rating	Light duty	Rated output capacity (kVA)	48	58	73	88	120	143
		Rated output current (A)	60	73	91	110	150	180
		Applicable motor output (kW)	30	37	45	55	75	90
		Applicable motor output (HP)	40	50	60	75	100	125
	Overload tolerance 120% of rated current can endure for 1 minute during every 5 minutes							
	Normal duty	Max. output frequency (Hz)	36	48	58	73	88	120
		Carrier frequency (kHz)	45	60	73	91	110	150
		Rated output capacity (kVA)	22	30	37	45	55	75
Rated output current (A)		30	40	53	60	75	100	
Applicable motor output (kW) 120% of rated current can endure for 1 minute during every 5 minutes 160% of rated current can endure for 3 seconds during every 30 seconds.								
Input Rating	Max. output frequency (Hz) 599Hz							
	Carrier frequency (kHz) 2~10kHz (6kHz)						2~9kHz (4kHz)	
	Input current (A) Light duty		60	73	91	110	150	180
	Input current (A) Normal duty		45	60	73	91	110	150
	Rated voltage / Frequency 3 相 AC 380V~480V (-15% ~ +10%), 50/60Hz							
	Operating voltage range 323~528Vac							
	Frequency tolerance 47~63Hz							
	Efficiency (%) >0.98 >0.98 >0.98 >0.98 >0.98 >0.98 >0.98 >0.98							
Power factor >0.98 >0.98 >0.98 >0.98 >0.98 >0.98 >0.98 >0.98								
Weight 26.5kg 42kg 59.5kg								
Cooling method Fan cooling								
Braking chopper Frame A to C (built-in)								
DC choke Built-in DC reactor EN6100-3-12								
EMC Filter Built-in EMC Filter EN61800-3 C1 & C2								

NOTE

- The value of the carrier frequency is a factory setting. To increase the carrier frequency, the current needs to be decreased. See derating curve diagram of Pr06-55 for more information.
- When a load is a shock or impact load, use a higher level model.

General Specifications

Control Characteristics	Control Method	1: V/F, 2: SVC, 3: PMSVC,
	Starting Torque	Reach up to 150% or above at 0.5Hz. Under FOC+PG mode, starting torque can reach 150% at 0Hz.
	V/F Curve	4 point adjustable V/F curve and square curve
	Speed Response Ability	5Hz (vector control can reach up to 40Hz)
	Torque Limit	Light duty: a max. of 160% torque current; Normal duty: a max. of 180% torque current
	Torque Accuracy	±5%
	Max. Output Frequency(Hz)	599.00 Hz
	Frequency Output Accuracy	Digital command:±0.01%, -10°C~+40°C; Analog command: ±0.1%, 25±10°C
	Output Frequency Resolution	Digital command:0.01Hz, Analog command: 0.03 X max. output frequency/60 Hz (±11 bit)
	Overload Tolerance	Normal duty: 120% of rated current can endure for1 minute during every 5 minutes 160% of rated current can endure for 3 seconds during every 30 seconds. Light duty: 120% of rated current can endure for1 minute
	Frequency Setting Signal	+10V~-10V, 0~+10V, 4~20mA, 0~20mA, Pulse input
	Accel./decel. Time	0.00~600.00/0.0~6000.0 seconds
Main control function	Torque control, Droop control, Speed/torque control switching, Feed forward control, Zero-servo control, Momentary power loss ride thru, Speed search, Over-torque detection, Torque limit, 17-step speed (max), Accel/decel time switch, S-curve accel/decel, 3-wire sequence, Auto-Tuning (rotational, stationary), Dwell, Cooling fan on/off switch, Slip compensation, Torque compensation, JOG frequency, Frequency upper/lower limit settings, DC injection braking at start/stop, High slip braking, PID control (with sleep function),Energy saving control, MODBUS communication (RS-485 RJ45, max. 115.2 kbps), Fault restart, Parameter copy	
Fan Control	Models above VFD300FP4E(includingVFD300FP4E) are PWM control Models below VFD220FP4E (including VFD220FP4E) are ON/OFF switch control	
Protection Characteristics	Motor Protection	Electronic thermal relay protection
	Over-current Protection	Over-current protection for 220% rated current 『Light duty: 130~135%』 current clamp 『Normal duty: 170~175%』
	Over-voltage Protection	Drive will stop when DC-BUS voltage exceeds 820V
	Over-temperature Protection	Built-in temperature sensor
	Stall Prevention	Stall prevention during acceleration, deceleration and running independently
	Restart After Instantaneous Power Failure	Parameter setting up to 20 seconds
Grounding Leakage Current Protection	Leakage current is higher than 50% of rated current of the AC motor drive	
Certifications	  , GB/T12668-2,	

9-2 Environment for Operation, Storage and Transportation

The drive must not be exposed to dust, direct sunlight, corrosive or flammable gases, oil mist, vapor, water drops or vibration. The atmosphere must contain only a low level of salt. (0.01 mg/cm² or less per year)

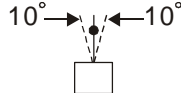
Ambient Conditions	Installation location	IEC60364-1/IEC60664-1 Pollution degree 2, Indoor use only	
	Ambient Temperature	Operation	- 15°C ~+ 50°C without derating, +51°C ~ 60°C with derating
		Storage	-25 °C ~ +70 °C
		Transportation	-25 °C ~ +70 °C
		Non-condensation, non-frozen	
	Rated Humidity	Operation	Max. 95%
		Storage/ Transportation	Max. 95%
		No condense allowed	
	Atmospheric Pressure	Operation/ Storage	86 to 106 kPa
		Transportation	70 to 106 kPa
	Withstand to harsh environments	IEC 60721-3	
		Operation	Class 3C3; Class 3S2; Class 3B1
		Storage	Class 1C2; Class 1S2
		Transportation	Class 2C2; Class 2S2
Altitude	Operation	Rated current available at 0 to 1000 m, reduced by 1% per 100 m over 1000 to 3000 m. Limited to 2000 m for the "Corner Grounded" distribution network.	
Vibration Operating	IEC 60068-2-6		
	Frame A: 2Hz ≤ f ≤ 13.2Hz/Amplitude 1mm; 13.2Hz < f ≤ 55Hz/Gravity 0.7G to 2.0G; 55Hz < f ≤ 512Hz/Gravity 2.0G Frame B: 2Hz ≤ f ≤ 13.2Hz/Amplitude 1mm; 13.2Hz < f ≤ 55Hz/Gravity 0.7G to 1.5G; 55Hz < f ≤ 512Hz/Gravity 1.5G Frame C;D0;D:A: 2Hz ≤ f ≤ 13.2Hz/Amplitude 1mm; 13.2Hz < f ≤ 55Hz/Gravity 0.7G to 1.0G; 55Hz < f ≤ 512Hz/Gravity 1.0G		
Shock Operating	IEC 60068-2-27		
	Frame A;B;C;D0: Max 30G;11 ms Frame D: Max 15G;11 ms		
In protective shipping package	Vibration	IEC 60068-2-64	
		10Hz ≤ f ≤ 100Hz/ASD : 1.0m2/s3 100Hz ≤ f ≤ 200Hz/ Slope : -3dB/octave	
	Shock	Cardboard box type: Free fall drop in accordance with ISTA 1A Wooden box type: In accordance with ISTA 1E (4 side incline) and ISTA 2B (Bottom side drop)	
Operation Position	Maximum permanent angle in relation to the normal vertical mounting position		

9-3 Derating of ambient temperature and altitude

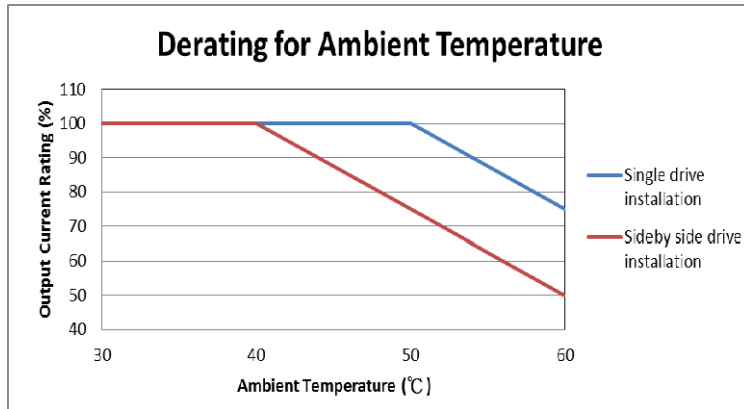

Chapter 10 Digital Keypad

10-1 Descriptions of Digital Keypad

10-2 Function of Digital Keypad KPC-CC02

10-3 TPEditor Installation Instruction

10-4 Fault Code Description of Digital Keypad KPC-CC02

10-5 Functions which are not supported when using TPEditor
with KPC-CC02

10-1 Descriptions of Digital Keypad

KPC-CC02





Communication Interface
RJ-45 (socket) · RS-485 interface;

Installation Method



1. Embedded type and can be put flat on the surface of the control box. The front cover is water proof.
2. Buy a MKC-KPPK model to do wall mounting or embedded mounting. Its protection level is IP66.
3. The maximum RJ45 extension lead is 5 m (16ft)
4. This keypad can only be used on Delta's motor drive CFP2000.

Descriptions of Keypad Functions

Key	Descriptions															
	<p>Start Operation Key</p> <ol style="list-style-type: none"> 1. It is only valid when the source of operation command is from the keypad. 2. It can operate the AC motor drive by the function setting and the RUN LED will be ON. 3. It can be pressed again and again at stop process. 															
	<p>Stop Command Key. This key has the highest processing priority in any situation.</p> <ol style="list-style-type: none"> 1. When it receives STOP command, no matter the AC motor drive is in operation or stop status, the AC motor drive needs to execute "STOP" command. 2. The RESET key can be used to reset the drive after the fault occurs. 3. The reasons why the error cannot be reset: <ol style="list-style-type: none"> a. Because the condition which triggers the fault is not cleared. When the condition is cleared, the fault can be reset. b. Because it's the fault status checking when power-on. When the condition is cleared, repower again, and the fault can be reset. 															
	<p>Operation Direction Key</p> <ol style="list-style-type: none"> 1. This key is only control the operation direction NOT for activate the drive. FWD: forward, REV: reverse. 2. Refer to the LED descriptions for more details. 															
	<p>ENTER Key</p> <p>Press ENTER and go to the next level. If it is the last level then press ENTER to execute the command.</p>															
	<p>ESC Key</p> <p>ESC key function is to leave current menu and return to the last menu. It is also functioned as a return key or cancel key in the sub-menu.</p>															
	<p>Press menu to return to main menu.</p> <p>Menu content:</p> <table border="0"> <tr> <td>1. Parameter setup</td> <td>6. Fault Record</td> <td>11. Startup Menu</td> </tr> <tr> <td>2. Copy Parameter</td> <td>7. Quick start</td> <td>12. Main Page</td> </tr> <tr> <td>3. Keypad Locked</td> <td>8. Display Setup</td> <td>13. PC Link</td> </tr> <tr> <td>4. PLC Function</td> <td>9. Time Setup</td> <td>14. Parameter Settings by Applications</td> </tr> <tr> <td>5. Copy PLC</td> <td>10. Language Setup</td> <td>15. History of Parameter Settings</td> </tr> </table>	1. Parameter setup	6. Fault Record	11. Startup Menu	2. Copy Parameter	7. Quick start	12. Main Page	3. Keypad Locked	8. Display Setup	13. PC Link	4. PLC Function	9. Time Setup	14. Parameter Settings by Applications	5. Copy PLC	10. Language Setup	15. History of Parameter Settings
1. Parameter setup	6. Fault Record	11. Startup Menu														
2. Copy Parameter	7. Quick start	12. Main Page														
3. Keypad Locked	8. Display Setup	13. PC Link														
4. PLC Function	9. Time Setup	14. Parameter Settings by Applications														
5. Copy PLC	10. Language Setup	15. History of Parameter Settings														
	<p>Direction: Left / Right / Up / Down</p> <ol style="list-style-type: none"> 1. In the numeric value setting mode, it is used to move the cursor and change the numeric value. 2. In the menu/text selection mode, it is used for item selection. 															
	<p>Function Key</p> <ol style="list-style-type: none"> 1. The functions keys have factory settings and can be defined by users. The factory settings of F1 and F4 work with the function list below. For example, F1 is JOG function, F4 is a speed setting key for adding/deleting user defined parameters. 															

Key	Descriptions
	<p>2. Other functions must be defined by TPEditor first. TPEditor software can be downloaded at: http://www.deltaww.com/services/DownloadCenter2.aspx?seclD=8&pid=2&tid=0&CID=06&itemID=060302&typeID=1&downloadID=&title=-- Select Product Series --&dataType=8;&check=1&hl=en-US Please refer to instruction for TPEditor in Chapter 10-3.</p>
	<p>HAND ON Key</p> <ol style="list-style-type: none"> 1. This key is executed by the parameter settings of the source of Hand frequency and hand operation. The factory settings of both source of Hand frequency and hand operation are the digital keypad. 2. Press HAND ON key at stop status, the setting will switch to hand frequency source and hand operation source. Press HAND ON key at operation status, it stops the AC motor drive first (display AHSP warning), and switch to hand frequency source and hand operation source. 3. Successful mode switching for KPC-CE01, "HAND" LED will be on; for KPC-CC02, it will display HAND mode on the screen.
	<ol style="list-style-type: none"> 1. This key is executed by the parameter settings of the source of AUTO frequency and AUTO operation. The factory setting is the external terminal (source of operation is 4-20mA). 2. Press Auto key at stop status, the setting will switch to hand frequency source and hand operation source. Press Auto key at operation status, it stops the AC motor drive first (display AHSP warning), and switch to auto frequency source and auto operation source. 3. Successful mode switching for KPC-CE01, "AUTO" LED will be on; for KPC-CC02, it will display AUTO mode on the screen

Descriptions of LED Functions

LED	Descriptions
	<p>Steady ON: operation indicator of the AC motor drive, including DC brake, zero speed, standby, restart after fault and speed search. Blinking: drive is decelerating to stop or in the status of base block. Steady OFF: drive doesn't execute the operation command</p>
	<p>Steady ON: stop indicator of the AC motor drive. Blinking: drive is in the standby status. Steady OFF: drive doesn't execute "STOP" command.</p>
	<p>Operation Direction LED</p> <ol style="list-style-type: none"> 1. Green light is on, the drive is running forward. 2. Red light is on, the drive is running backward. 3. Twinkling light: the drive is changing direction.

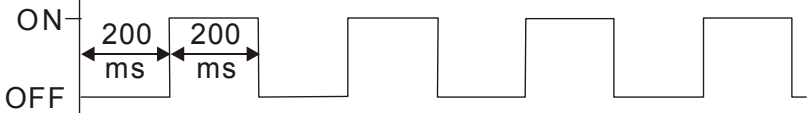
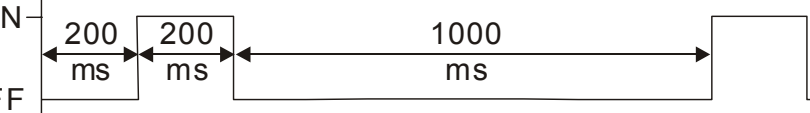
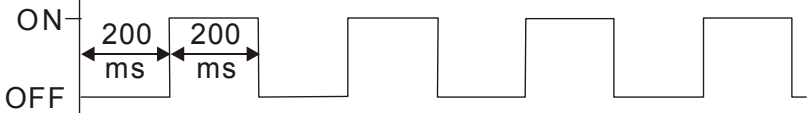
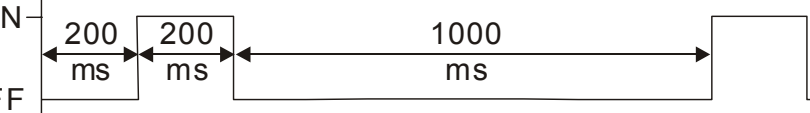
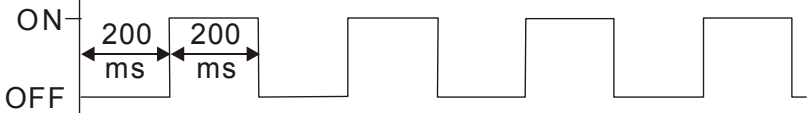
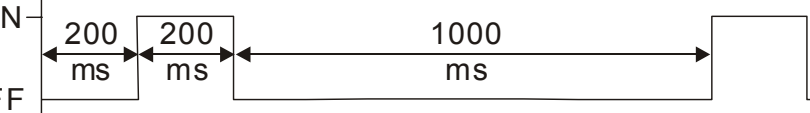
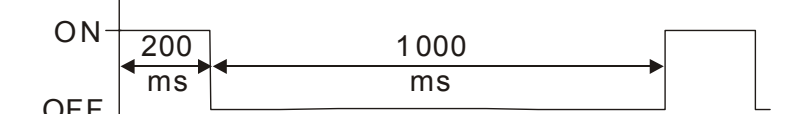
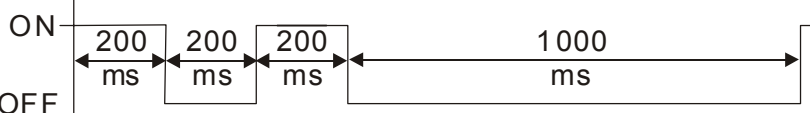
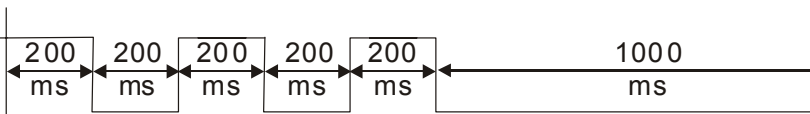
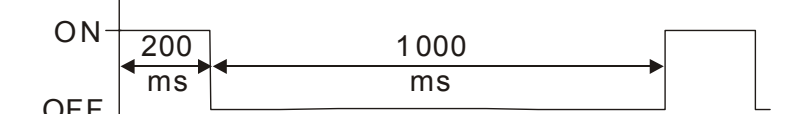
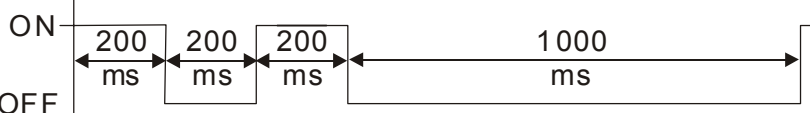
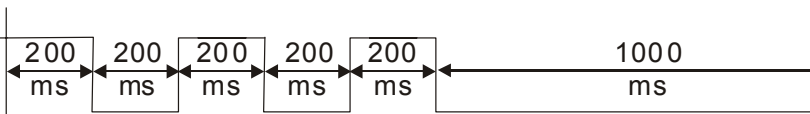
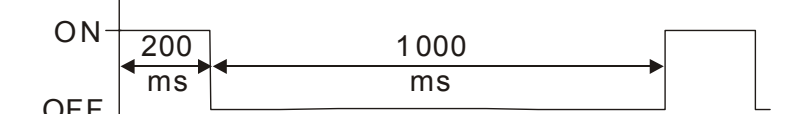
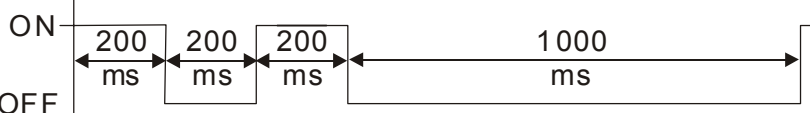
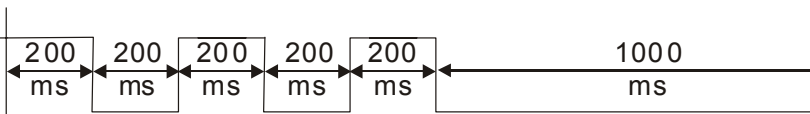
LED	Descriptions												
CANopen~ "RUN"	<p>RUN LED:</p> <table border="1"> <thead> <tr> <th data-bbox="339 219 475 280">LED status</th> <th data-bbox="475 219 1463 280">Condition/State</th> </tr> </thead> <tbody> <tr> <td data-bbox="339 280 475 342">OFF</td> <td data-bbox="475 280 1463 342">CANopen at initial No LED</td> </tr> <tr> <td data-bbox="339 342 475 517">Blinking</td> <td data-bbox="475 342 1463 517"> CANopen at pre-operation  </td> </tr> <tr> <td data-bbox="339 517 475 701">Single flash</td> <td data-bbox="475 517 1463 701"> CANopen at stopped  </td> </tr> <tr> <td data-bbox="339 701 475 763">ON</td> <td data-bbox="475 701 1463 763">CANopen at operation status No LED</td> </tr> </tbody> </table>	LED status	Condition/State	OFF	CANopen at initial No LED	Blinking	CANopen at pre-operation 	Single flash	CANopen at stopped 	ON	CANopen at operation status No LED		
	LED status	Condition/State											
	OFF	CANopen at initial No LED											
	Blinking	CANopen at pre-operation 											
	Single flash	CANopen at stopped 											
ON	CANopen at operation status No LED												
CANopen~ "ERR"	<p>ERR LED:</p> <table border="1"> <thead> <tr> <th data-bbox="339 846 475 907">LED status</th> <th data-bbox="475 846 1463 907">Condition/ State</th> </tr> </thead> <tbody> <tr> <td data-bbox="339 907 475 947">OFF</td> <td data-bbox="475 907 1463 947">No Error</td> </tr> <tr> <td data-bbox="339 947 475 1131">Single flash</td> <td data-bbox="475 947 1463 1131"> One message fail  </td> </tr> <tr> <td data-bbox="339 1131 475 1305">Double flash</td> <td data-bbox="475 1131 1463 1305"> Guarding fail or heartbeat fail  </td> </tr> <tr> <td data-bbox="339 1305 475 1489">Triple flash</td> <td data-bbox="475 1305 1463 1489"> SYNC fail  </td> </tr> <tr> <td data-bbox="339 1489 475 1529">ON</td> <td data-bbox="475 1489 1463 1529">Bus off</td> </tr> </tbody> </table>	LED status	Condition/ State	OFF	No Error	Single flash	One message fail 	Double flash	Guarding fail or heartbeat fail 	Triple flash	SYNC fail 	ON	Bus off
	LED status	Condition/ State											
	OFF	No Error											
	Single flash	One message fail 											
	Double flash	Guarding fail or heartbeat fail 											
Triple flash	SYNC fail 												
ON	Bus off												

10-2 Function of Digital Keypad KPC-CC02

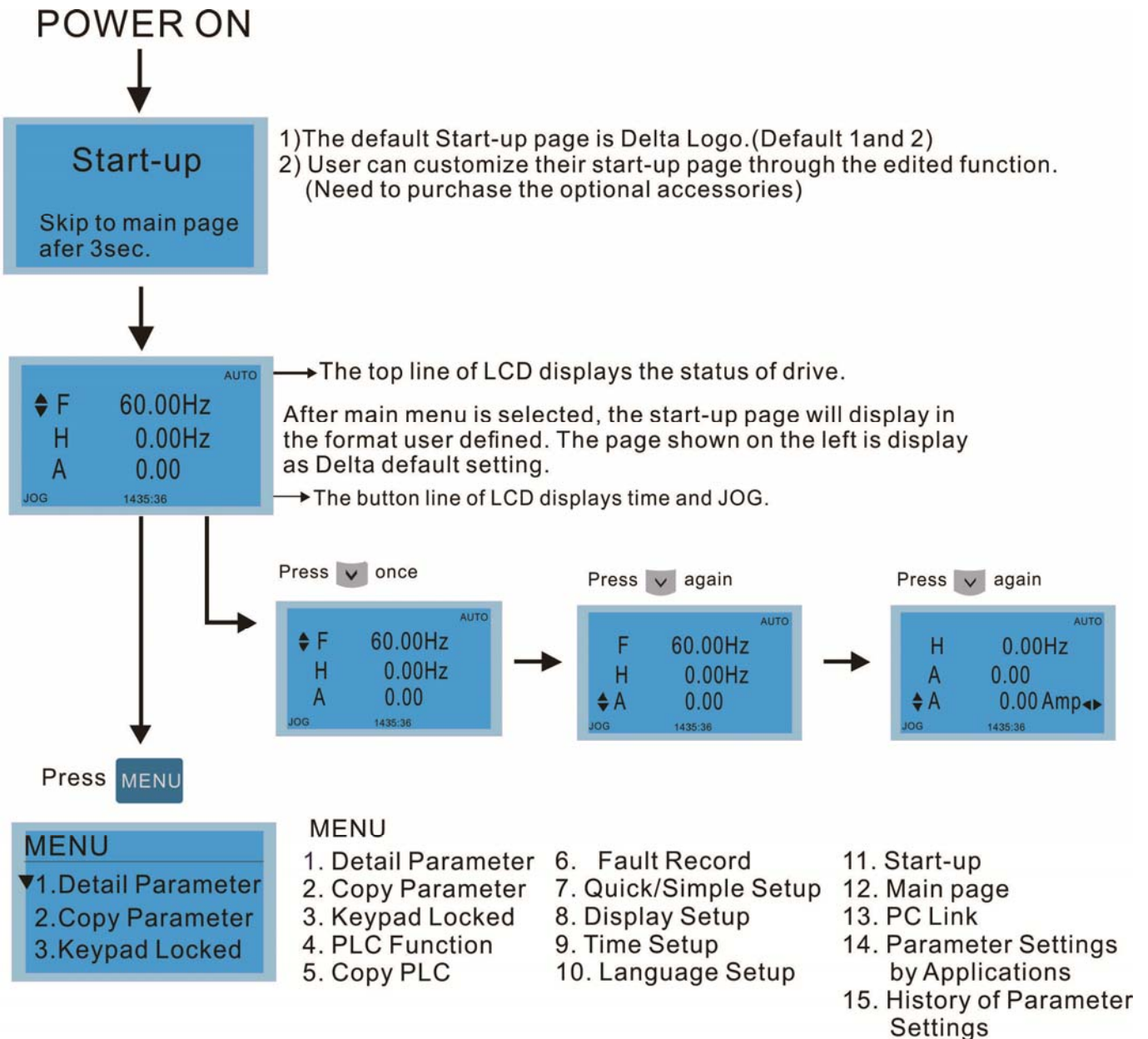

NOTE

1. Startup page can only display pictures, no flash.
2. When Power ON, it will display startup page then the main page. The main page displays Delta's default setting F/H/A/U, the display order can be set by Pr.00.03 (Startup display). When the selected item is U page, use left key and right key to switch between the items, the display order of U page is set by Pr.00.04 (User display).

Display Icon



- : present setting
- ▼ : roll down the page for more options

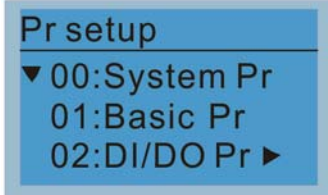

- ▶ : show complete sentence
- Press [left arrow] [right arrow] for complete information

Display item

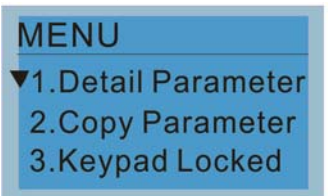

MENU

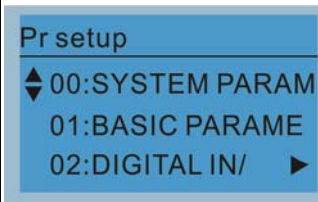
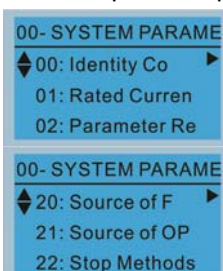
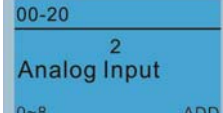
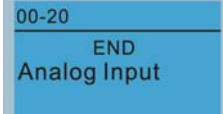

- | | | |
|---------------------|-----------------------|--|
| 1. Detail Parameter | 6. Fault Record | 11. Start-up |
| 2. Copy Parameter | 7. Quick/Simple Setup | 12. Main page |
| 3. Keypad Locked | 8. Display Setup | 13. PC Link |
| 4. PLC Function | 9. Time Setup | 14. Parameter Settings by Applications |
| 5. Copy PLC | 10. Language Setup | 15. History of Parameter Settings |

1. Parameter Setup



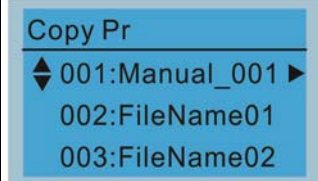
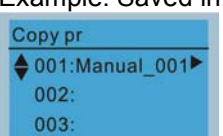
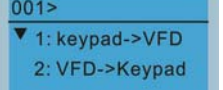

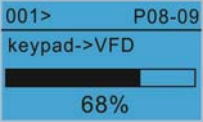
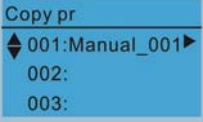
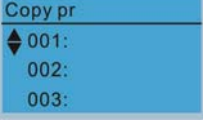
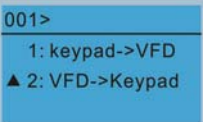

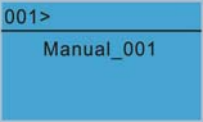
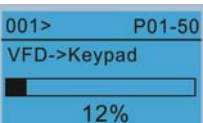
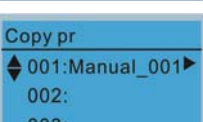
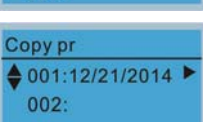
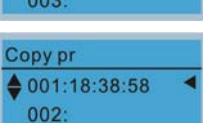
 <p>Press ENTER key to select. Press Up/Down key to select parameter group. Once a parameter group is selected, press ENTER key to go into that group.</p>	<p>For example: Setup source of master frequency command.</p>  <p>Once in the Group 00 Motor Drive Parameter, Use Up/Down key to select parameter 20: Auto Frequency Command.</p>  <p>When this parameter is selected, press ENTER key to go to this parameter's setting menu.</p> <p>Use Up/Down key to choose a setting. For example: Choose "2 Analogue Input, then press the ENTER key.</p>  <p>After pressing the ENTER key, an END will be displayed which means that the parameter setting is done.</p>
---	---

2. Copy Parameter

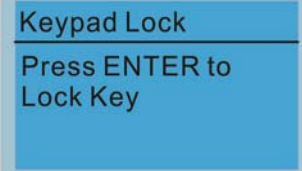



 <p>Press ENTER key to go to 001~004: content storage</p>	<p>4 duplicates are provided</p> <p>The steps are shown in the example below.</p> <p>Example: Saved in the motor drive.</p>  <p>1 Go to Copy Parameter 2 Select the parameter group which needs to be copied and press ENTER key.</p>  <p>1 Select 1: Save in the motor drive. 2. Press ENTER key to go to "Save in the motor drive" screen.</p>
--	--

	<p>Begin to copy parameters until it is done.</p>
	<p>Once copying parameters is done, keypad will automatically be back to this screen.</p>
<p>Example: Saved in the keypad.</p>	
	<ol style="list-style-type: none"> 1. Once copying parameters is done, keypad will automatically be back to this screen. 2. Select the parameter group which needs to be copied and press ENTER key.
	<p>Press ENTER key to go to “Save in the motor drive” screen.</p>
	<p>Use Up/Down key to select a symbol. Use Left/Right key to move the cursor to select a file name.</p>
<p>String & Symbol Table: ! " # \$ % & ' () * + , - . / 0 1 2 3 4 5 6 7 8 9 : ; < = > ? @ A B C D E F G H I J K L M N O P Q R S T U V W X Y Z [\] ^ _ ` a b c d e f g h i j k l m n o p q r s t u v w x y z { } ~</p>	
	<p>Once the file name is confirmed, press ENTER key.</p>
	<p>To begin copying parameters until it is done.</p>
	<p>When copying parameters is completed, keypad will automatically be back to this screen.</p>
	<p>Press Right key to see the date of copying parameters.</p>
	<p>Press Right key to see the time of copying parameters.</p>

3. Keypad locked

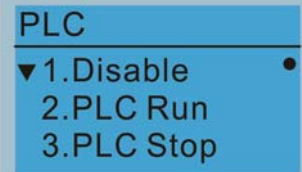
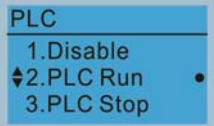
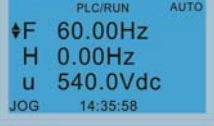
	<p>Keypad Locked</p> <p>This function is used to lock the keypad. The main page would not display “keypad locked” when the keypad is locked, however it will display the message “please press ESC and then ENTER to unlock the keypad” when any key is pressed.</p>
<p>Press ENTER key to lock.</p>	 <p>When the keypad is locked, the main screen doesn't display any status to show that.</p>
	<p>Press any key on the keypad; a screen as shown in image on the left will be displayed.</p>
	<p>If ESC key is not pressed, the keypad will automatically be back to this screen.</p>
	<p>The keypad is still locked at this moment. By pressing any key, a screen as shown in the image on the left will still be displayed.</p>
	<p>Press ESC for 3 seconds to unlock the keypad and the keypad will be back to this screen. Then each key on the keypad is functional.</p> <p>Turn off the power and turn on the power again will not lock keypad.</p>

4. PLC Function



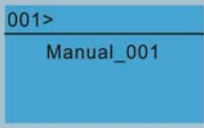
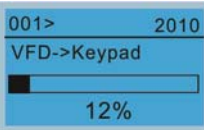
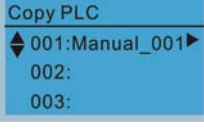
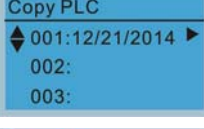
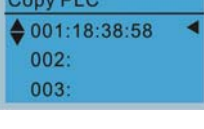

	<p>When activate and stop PLC function, the PLC status will be displayed on main page of Delta default setting.</p>
<p>Press Up/Down key to select a PLC's function. Then press ENTER.</p>	 <p>Option 2: Enable PLC function</p>
	 <p>Factory setting on the main screen displays PLC/RUN status bar.</p>
	<p>Option 3: Disable PLC function</p>
	 <p>Factory setting on the main screen displays PLC/STOP status bar</p>
	<p>If the PLC program is not available in the control board, PLFF warning will be displayed when choosing option 2 or 3. In this case, select option 1: No Function to clear PLFF warning.</p>
	<p>The PLC function of KPC-CE01 can only displays:</p> <ol style="list-style-type: none"> 1. PLC0 2. PLC1 3. PLC2

5. Copy PLC

	<p>4 duplicates are provided</p> <p>The steps are shown in the example below.</p> <p>Example: Saved in the motor drive.</p> <ol style="list-style-type: none"> 1 Go to Copy PLC 2 Select a parameter group to copy then press ENTER <p>1 Select 1: Save in the motor drive. 2. Press ENTER key to go to “Save in the motor drive” screen.</p> <p>Begin to copy PLC until it is done.</p> <p>Once copying PLC is done, keypad will automatically be back to this screen.</p> <p>NOTE</p> <p>If “Option 1: Save in the motor drive” is selected, verify if the PLC program is built-in to KPC-CC02 keypad. If PLC program is not available in the keypad while “Option 1: Save in the motor drive” is selected, an “ERR8 Warning: Type not matching” will be display on the screen.</p> <p>Unplug and plug back the keypad while copying the PLC program will have a CPLt warning.</p> <p>Example: Saved in the keypad.</p> <ol style="list-style-type: none"> 1. Once copying PLC is done, keypad will automatically be back to this screen. 2. Select the parameter group which needs to be copied and press ENTER key. <p>Press ENTER key to go to “Save in the motor drive” screen.</p> <p>If WPLSoft editor is installed and password is set, enter the password to save the file onto digital display.</p> <p>Use Up/Down key to select a symbol. Use Left/Right key to move the cursor to select a file name.</p> <p>String & Symbol Table: ! " # \$ % & ' () * + , - . / 0 1 2 3 4 5 6 7 8 9 : ; < = > ? @ A B C D E F G H I J K L M N O P Q R S T U V W X Y Z [\] ^ _ ` a b c d e f g h i j k l m n o p q r s t u v w x y z { } ~</p>

		<p>Once the file name is confirmed, press ENTER key.</p>
		<p>To begin copying parameters until it is done.</p>
		<p>When copying parameters is completed, keypad will automatically be back to this screen.</p>
		<p>Press Right key to see the date of copying parameters.</p>
		<p>Press Right key to see the time of copying parameters.</p>

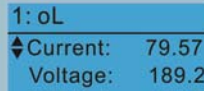
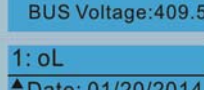
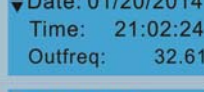
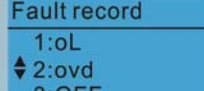
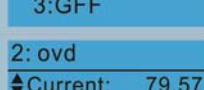
6. Fault record

	<p>Able to store 6 error code (Keypad V1.02 and previous versions) Able to store 20 error code (Keypad V1.03 and later version) The most recent error record is shown as the first record. Select an error record to see its detail such as date, time, frequency, current, voltage, DCBUS voltage)</p>	
<p>Press ENTER key to select.</p>		
		<p>Press Up/Down key to select an error record. After selecting an error code, press ENTER to see that error record's detail</p>
		
		<p>Press Up/Down key to see an error record's detail such as date, time, frequency, current, voltage, DCBus voltage.</p>
		<p>Press Up/Down key to select an error record. After selecting an error code, press ENTER to see that error record's detail</p>
		
		<p>Press Up/Down key to see an error record's detail such as date, time, frequency, current, voltage, DCBus voltage.</p>
	<p> NOTE Fault actions of AC motor drive are record and save to KPC-CC02. When KPC-CC02 is removed and apply to another AC motor drive, the previous fault records will not be deleted. The new fault records of the present AC motor drive will accumulate to KPC-CC02.</p>	

7. Quick Start

<div data-bbox="199 165 507 353"> <p>Quick Start</p> <p>▼ 1: V/F Mode 2: VFPG Mode 3: SVC Mode</p> </div> <p data-bbox="193 365 555 398">Press ENTER key to select.</p> <p data-bbox="193 432 331 461">Quick Start:</p> <ol data-bbox="193 463 411 645" style="list-style-type: none"> 1. V/F Mode 2. VFPG Mode 3. SVC Mode 4. FOCPG Mode 5. TQCPG Mode 6. My Mode 	<p data-bbox="571 174 1369 208">Description: PG mode is only applicable on C2000/ CH2000 series.</p> <p data-bbox="571 226 746 255">1. VF Mode</p> <div data-bbox="643 277 906 434"> <p>V/F Mode :P00-07</p> <p>◆01:Password De</p> <p>02:Password Inp</p> <p>03:Control Meth</p> </div> <p data-bbox="643 461 906 490">01:Password Decoder</p> <div data-bbox="643 517 906 674"> <p>00-07</p> <p>0</p> <p>Password Decoder</p> <p>0~65535</p> </div> <p data-bbox="922 264 991 293">Items</p> <ol data-bbox="922 295 1449 1238" style="list-style-type: none"> 1. Parameter Protection Password Input (P00-07) 2. Parameter Protection Password Setting (P00-08) 3. Control Mode (P00-10) 4. Control of Speed Mode (P00-11) 5. Load Selection (P00-16) 6. Source of the Master Frequency Command (AUTO) (P00-20) 7. Source of the Operation Command (AUTO) (P00-21) 8. Stop Method (P00-22) 9. Digital Keypad STOP function (P00-32) 10. Max. Operation Frequency (P01-00) 11. Base Frequency of Motor 1 (P01-01) 12. Max. Output Voltage Setting of Motor 1 (P01-02) 13. Min. Output Frequency of Motor 1 (P01-07) 14. Min. Output Voltage of Motor 1 (P01-08) 15. Output Frequency Upper Limit (P01-10) 16. Output Frequency Lower Limit (P01-11) 17. Accel. Time 1 (P01-12) 18. Decel Time 1 (P01-13) 19. Over-voltage Stall Prevention (P06-01) 20. Software Brake Level (P07-00) 21. Filter Time of Torque Command (P07-24) 22. Filter Time of Slip Compensation (P07-25) 23. Slip Compensation Gain (P07-27) <p data-bbox="571 1249 786 1279">2. VFPG Mode</p> <div data-bbox="643 1301 906 1458"> <p>VFPG Mode :P00-07</p> <p>◆01:Password De</p> <p>02:Password Inp</p> <p>03:Control Meth</p> </div> <p data-bbox="643 1485 906 1514">01: Password Decoder</p> <div data-bbox="643 1541 906 1697"> <p>00-07</p> <p>0</p> <p>Password Decoder</p> <p>0~65535</p> </div> <p data-bbox="922 1290 991 1319">Items</p> <ol data-bbox="922 1321 1449 2112" style="list-style-type: none"> 1. Parameter Protection Password Input (P00-07) 2. Parameter Protection Password Setting (P00-08) 3. Control Mode (P00-10) 4. Control of Speed Mode (P00-11) 5. Load Selection (P00-16) 6. Source of the Master Frequency Command (AUTO) (P00-20) 7. Source of the Operation Command (AUTO) (P00-21) 8. Stop Method (P00-22) 9. Digital Keypad STOP function (P00-32) 10. Max. Operation Frequency (P01-00) 11. Base Frequency of Motor 1 (P01-01) 12. Max. Output Voltage Setting of Motor 1 (P01-02) 13. Min. Output Frequency of Motor 1 (P01-07) 14. Min. Output Voltage of Motor 1 (P01-08) 15. Output Frequency Upper Limit (P01-10) 16. Output Frequency Lower Limit (P01-11) 17. Accel. Time 1 (P01-12)
---	---

	<p>18. Decel Time 1 (P01-13)</p> <p>19. Over-voltage Stall Prevention (P06-01)</p> <p>20. Software Brake Level (P07-00)</p> <p>21. Filter Time of Torque Command (P07-24)</p> <p>22. Filter Time of Slip Compensation (P07-25)</p> <p>23. Slip Compensation Gain (P07-27)</p> <p>24. Encoder Type Selection (P10-00)</p> <p>25. Encoder Pulse (P10-01)</p> <p>26. Encoder Input Type Setting (P10-02)</p> <p>27. ASR Control (P) 1 (P11-06)</p> <p>28. ASR Control (I) 1 (P11-07)</p> <p>29. ASR Control (P) 2 (P11-08)</p> <p>30. ASR Control (I) 2 (P11-09)</p> <p>31. P Gain of Zero Speed (P11-10)</p> <p>32. I Gain of Zero Speed (P11-11)</p> <p>3. SVC Mode</p> <div data-bbox="614 728 877 884" style="border: 1px solid black; padding: 5px; margin: 10px 0;"> <p>SVC Mode :P00-07</p> <p>01:Password De</p> <p>02:Password Inp</p> <p>03:Control Meth</p> </div> <p>01: Password Decoder</p> <div data-bbox="614 974 877 1131" style="border: 1px solid black; padding: 5px; margin: 10px 0;"> <p>00-07</p> <p>0</p> <p>Password Decoder</p> <p>0-65535</p> </div> <p>Items</p> <ol style="list-style-type: none"> 1. Parameter Protection Password Input (P00-07) 2. Parameter Protection Password Setting (P00-08) 3. Control Mode (P00-10) 4. Control of Speed Mode (P00-11) 5. Load Selection (P00-16) 6. Carrier Frequency (P00-17) 7. Source of the Master Frequency Command (AUTO) (P00-20) 8. Source of the Operation Command (AUTO) (P00-21) 9. Stop Method (P00-22) 10. Digital Keypad STOP function (P00-32) 11. Max. Operation Frequency (P01-00) 12. Base Frequency of Motor 1 (P01-01) 13. Max. Output Voltage Setting of Motor 1 (P01-02) 14. Min. Output Frequency of Motor 1 (P01-07) 15. Min. Output Voltage of Motor 1 (P01-08) 16. Output Frequency Upper Limit (P01-10) 17. Output Frequency Lower Limit (P01-11) 18. Accel. Time 1 (P01-12) 19. Decel Time 1 (P01-13) 20. Full-load Current of Induction Motor 1 (P05-01) 21. Rated Power of Induction Motor 1 (P05-02) 22. Rated Speed of Induction Motor 1 (P05-03) 23. Pole Number of Induction Motor 1 (P05-04) 24. No-load Current of Induction Motor 1 (P05-05) 25. Over-voltage Stall Prevention (P06-01) 26. Over-current Stall Prevention during Acceleration (P06-03) 27. Derating Protection (P06-55) 28. Software Brake Level (P07-00)
--	--

29. Emergency Stop (EF) & Force to Stop Selection (P07-20)
30. Filter Time of Torque Command (P07-24)
31. Filter Time of Slip Compensation (P07-25)
32. Slip Compensation Gain (P07-27)

4. FOCPG Mode

FOCPG Mode :P00-07
 ↕01:Password De
 02:Password Inp
 03:Control Meth

01: Password Decoder

00-07
 0
 Password Decoder
 0~65535

Items

1. Parameter Protection Password Input (P00-07)
2. Parameter Protection Password Setting (P00-08)
3. Control Mode (P00-10)
4. Control of Speed Mode (P00-11)
5. Source of the Master Frequency Command (AUTO) (P00-20)
6. Source of the Operation Command (AUTO) (P00-21)
7. Stop Method (P00-22)
8. Max. Operation Frequency (P01-00)
9. Base Frequency of Motor 1 (P01-01)
10. Max. Output Voltage Setting of Motor 1 (P01-02)
11. Output Frequency Upper Limit (P01-10)
12. Output Frequency Lower Limit (P01-11)
13. Accel. Time 1 (P01-12)
14. Decel Time 1 (P01-13)
15. Full-load Current of Induction Motor 1 (P05-01)
16. Rated Power of Induction Motor 1 (P05-02)
17. Rated Speed of Induction Motor 1 (P05-03)
18. Pole Number of Induction Motor 1 (P05-04)
19. No-load Current of Induction Motor 1 (P05-05)
20. Over-voltage Stall Prevention (P06-01)
21. Over-current Stall Prevention during Acceleration (P06-03)
22. Derating Protection (P06-55)
23. Software Brake Level (P07-00)
24. Emergency Stop (EF) & Force to Stop Selection (P07-20)
25. Encoder Type Selection (P10-00)
26. Encoder Pulse (P10-01)
27. Encoder Input Type Setting (P10-02)
28. System Control (P11-00)
29. Per Unit of System Inertia (P11-01)
30. ASR1 Low-speed Bandwidth (P11-03)
31. ASR2 High-speed Bandwidth (P11-04)
32. Zero-speed Bandwidth (P11-05)

5. TQCPG Mode

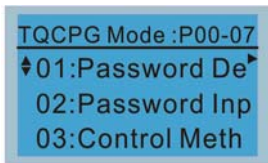

01: Password Decoder

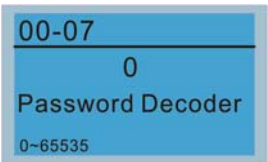

Items

1. Password Input (Decode) (P00-07)
2. Password Setting (P00-08)
3. Control Mode (P00-10)
4. Control of Speed Mode (P00-11)
5. Source of the Master Frequency Command (P00-20)
6. Source of the Operation Command (P00-21)
7. Max. Operation Frequency (P01-00)
8. Base Frequency of Motor 1 (P01-01)
9. Max. Output Voltage Setting of Motor 1 (P01-02)
10. Full-load Current of Induction Motor 1 (P05-01)
11. Rated Power of Induction Motor 1 (P05-02)
12. Rated Speed of Induction Motor 1 (P05-03)
13. Pole Number of Induction Motor 1 (P05-04)
14. No-load Current of Induction Motor 1 (P05-05)
15. Over-voltage Stall Prevention (P06-01)
16. Software Brake Level (P07-00)
17. Encoder Type Selection (P10-00)
18. Encoder Pulse (P10-01)
19. Encoder Input Type Setting (P10-02)
20. System Control (P11-00)
21. Per Unit of System Inertia (P11-01)
22. ASR1 Low-speed Bandwidth (P11-03)
23. ASR2 High-speed Bandwidth (P11-04)
24. Zero-speed Bandwidth (P11-05)
25. Max. Torque Command (P11-27)
26. Source of Torque Offset (P11-28)
27. Torque Offset Setting (P11-29)
28. Source of Torque Command (P11-33)
29. Torque Command (P11-34)
30. Speed Limit Selection (P11-36)
31. Forward Speed Limit (torque mode) (P11-37)
32. Reverse Speed Limit (torque mode) (P11-38)

6. My Mode

My Mode

```

01:
02:
03:

```

Click F4 in parameter setting page, the parameter will save to My Mode. To delete or correct the parameter, enter this parameter and click the "DEL" on the bottom right corner.

Items

It can save 01~32 sets of parameters (Pr).

Setup process

1. Go to Parameter Setup function.

Press ENTER to select the parameter which you need to use. There is an ADD on the bottom right-hand corner of the screen. Press F4 on the key pad to add this parameter to My Mode

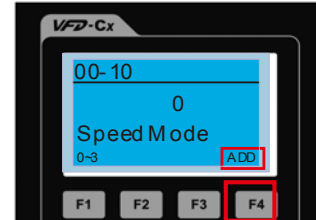

```

00-10
Press ENTER to
Save MyMode

```

2. The parameter (Pr) will be displayed in My mode if it is properly saved. To correct or to delete this Pr. clicks DEL.

```

My Mode :P00-10
01: Control Met ▶
02: MAX Output
03:

```

3. To delete a parameter, go to My Mode and select a parameter which you need to delete.

Press ENTER to enter the parameter setting screen. There is a DEL on the bottom left-hand corner of the screen. Press F4 on the keypad to delete this parameter from My Mode.

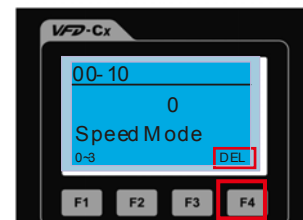

```

00-10
Press ENTER to
Delete MyMode

```











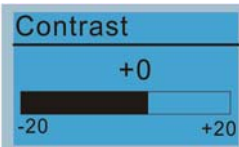

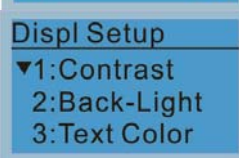

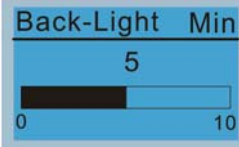

4. After pressing ENTER to delete <01 Control Mode>, the <02 Maximum Operating Frequency > will automatically replace <01 Control Mode>.

```

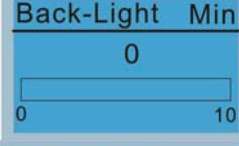
My Mode :P01-00
01: MAX Output ▶
02:
03:

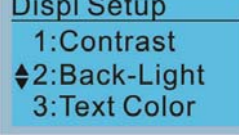

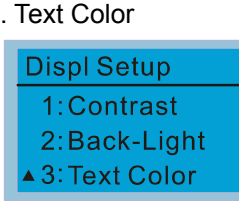

```

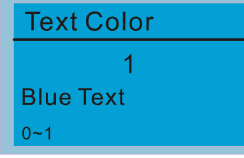
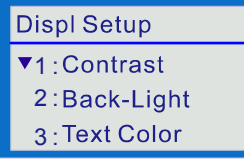
8. Display setup

	<p>1. Contrast</p> 	<p>Use Up/Down key to adjust the setting value.</p>
<p>Press ENTER key to setting menu.</p>		<p>After selecting a setting value. Press ENTER to see screen's display after contrast is adjusted to be +10.</p>
		<p>When the setting value is 0 Min, the back light will be steady on.</p>
		<p>Then press ENTER.</p> <p>After select a setting value Press ENTER to see screen's display result after contrast is adjusted to be -10.</p>
	<p>2. Back-light</p> 	<p>Press ENTER to go to Back Light Time Setting screen.</p>
		<p>Use Up / Down key to adjust the setting value.</p>
		<p>When the setting value is 0 Min, the back light will be steady on.</p>
		<p>When the setting value is 10 Min, the backlight will be off in 10 minutes.</p>
	<p>3. Text Color</p> 	<p>Press ENTER to go to Text Color Setting screen.</p>
		<p>The default value is White Text.</p>

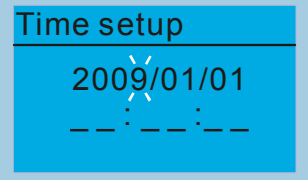
	 	<p>Use Up / Down key to adjust the setting value.</p> <p>The setting value changes to Blue Text.</p>
--	--	--

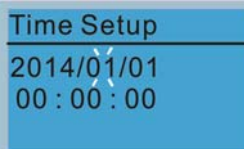
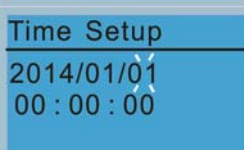
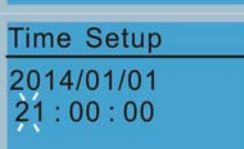
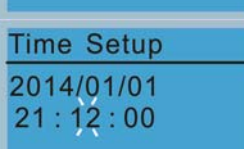
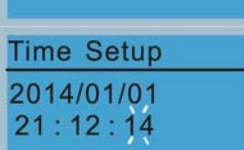
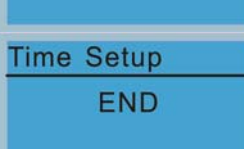

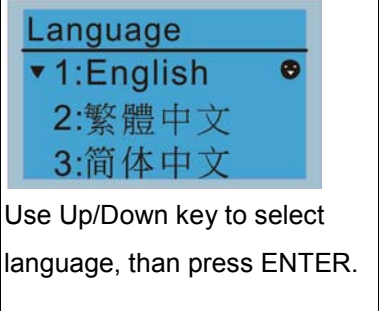

9. Time setting

 <p>Use Left/Right key to select Year, Month, Day, Hour, Minute or Second to set up</p>		Use Up/Down key to set up Year
		Use Up/Down key to set up Month
		Use Up/Down key to set up day
		Use Up/Down key to set up hour
		Use Up/Down key to set up Minute
		Use Up/Down key to set up Second
		After setting up, press ENTER to confirm the setup.
		<p> NOTE</p> <p>Limitation: The charging process of the super capacitor will finish in about 6 minutes. When the digital keypad is removed, the time setting will be in standby status for 7 days. After this period, the time needs to be reset.</p>

10. Language setup

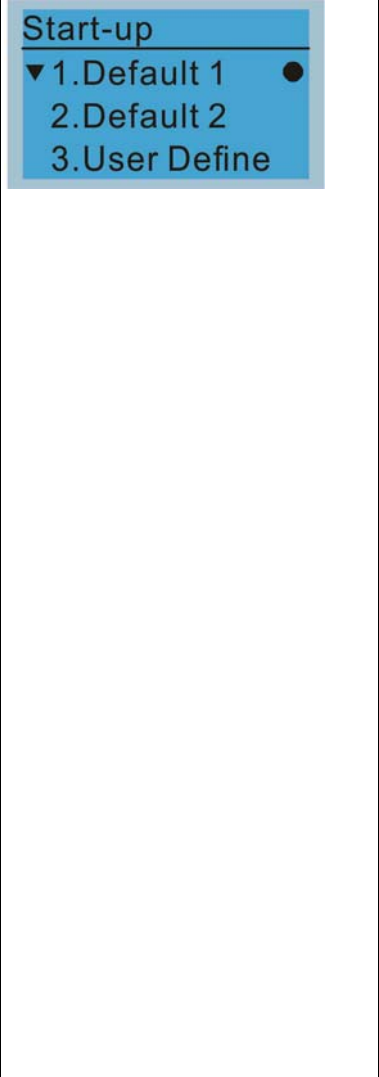
	<p>Language setting option is displayed in the language of the user's choice. Language setting options:</p> <table border="0"> <tr> <td>1. English</td> <td>5. Русский</td> </tr> <tr> <td>2. 繁體中文</td> <td>6. Español</td> </tr> <tr> <td>3. 简体中文</td> <td>7. Português</td> </tr> <tr> <td>4. Türkçe</td> <td>8. Français</td> </tr> <tr> <td></td> <td>9. Polski</td> </tr> </table>	1. English	5. Русский	2. 繁體中文	6. Español	3. 简体中文	7. Português	4. Türkçe	8. Français		9. Polski
1. English	5. Русский										
2. 繁體中文	6. Español										
3. 简体中文	7. Português										
4. Türkçe	8. Français										
	9. Polski										

11. Startup-up

	<p>1. Default 1 DELTA LOGO</p>  <p>2. Default 2 DELTA Text</p>  <p>3. User Defined: optional accessory is require (TPEditor & USB/RS-485 Communication Interface-IFD6530) Install an editing accessory would allow users to design their own start-up page. If editor accessory is not installed, "user defined" option will display a blank page.</p>  <p><u>USB/RS-485 Communication Interface-IFD6530</u> Please refer to Chapter 07 Optional Accessories for more detail.</p> <p><u>TPEditor</u> Go to Delta's website to download TPEditor V1.60 or later versions. http://www.deltaww.com/services/DownloadCenter2.aspx?seclD=8&pid=2&tid=0&CID=06&itemID=060302&typeID=1&downloadID=&title=-- Select Product Series --&dataType=8;&check=1&hl=en-US</p>
--	--

12. Main page

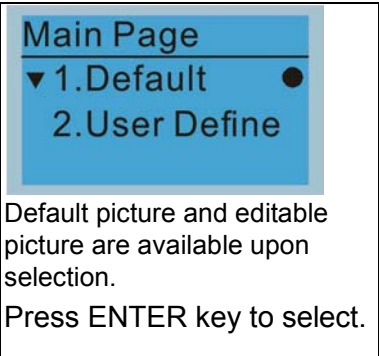
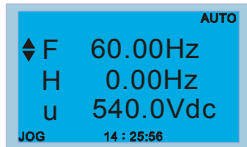
	<p>1. Default page</p>  <p>F 60.00Hz >>> H >>> A >>> U (circulate)</p> <p>2. User Defined: optional accessory is require (TPEditor & USB/RS-485 Communication Interface-IFD6530) Install an editing accessory would allow users to design their own start-up</p>
---	--

page. If editor accessory is not installed, “user defined” option will display a blank page.

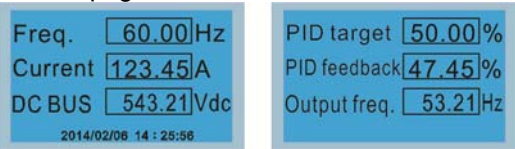

USB/RS-485 Communication Interface-IFD6530
Please refer to Chapter 07 Optional Accessories for more detail.

TPEditor
Go to Delta's website to download TPEditor V1.60 or later versions.
<http://www.deltaww.com/services/DownloadCenter2.aspx?seclD=8&pid=2&tid=0&CID=06&itemID=060302&typeID=1&dowloadID=&title=-- Select Product Series --&dataType=8;&check=1&hl=en-US>

13. PC Link

PC Link

- ▼1. TPEditor
- 2. VFDSOft

1. TPEditor: This function allows users to connect the keypad to a computer then to download and edit user defined pages.

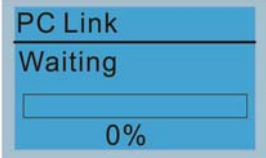

Click ENTER to go to <Waiting to connect to PC>

In TPEditor, choose <Communication>, then choose “Write to HMI”

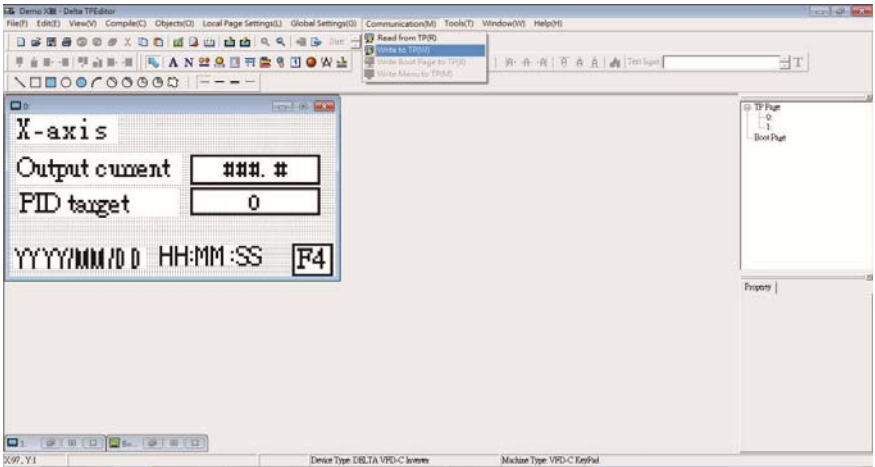

Choose <YES> in the <Confirm to Write> dialogue box.

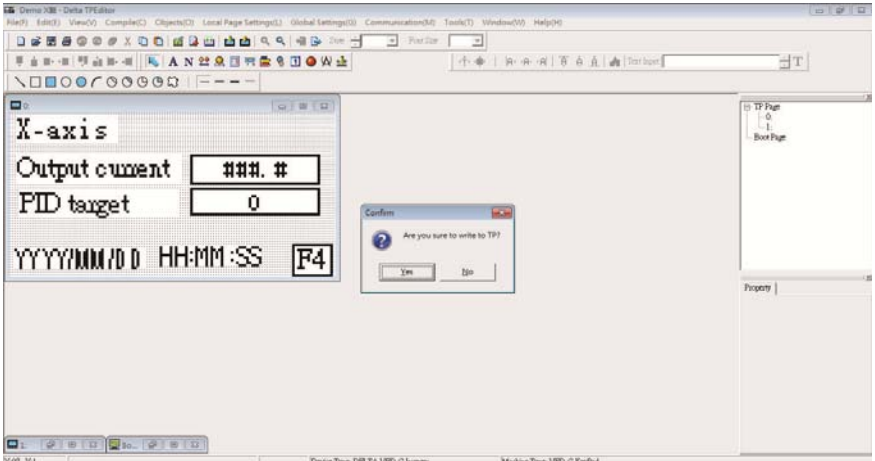

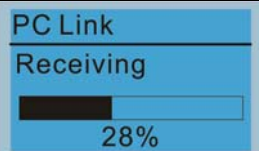

Start downloading pages to edit KPC-CC02.



Download completed

2. VFDSOft: this function allows user to link to the VFDSOft Operating software then to upload data

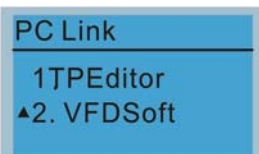

Start downloading pages to edit to KPC-CC02

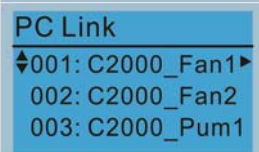

Use Up/Down key to select a parameter group to upload to VFDSOft. Press ENTER

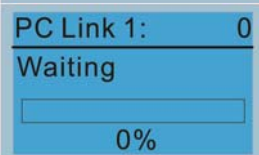

Waiting to connect to PC

Open VFDSOft, choose <Parameter Manager function>

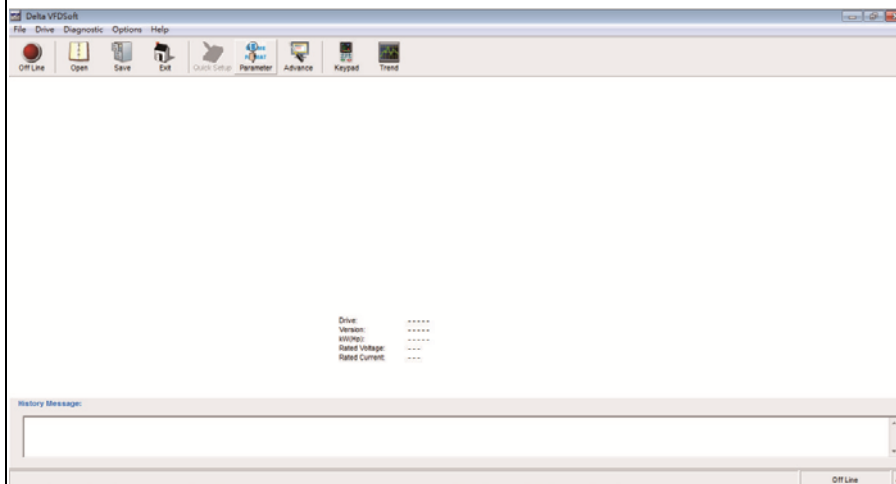

In Parameter Manager, choose <Load parameter table from KPC-CC02>

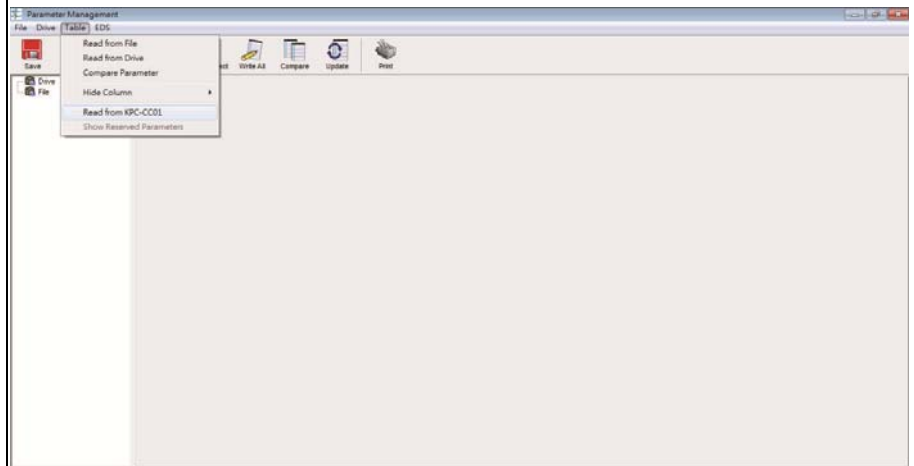

Choose the right communication port and click OK

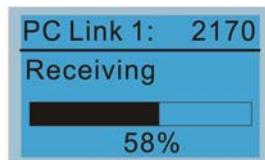
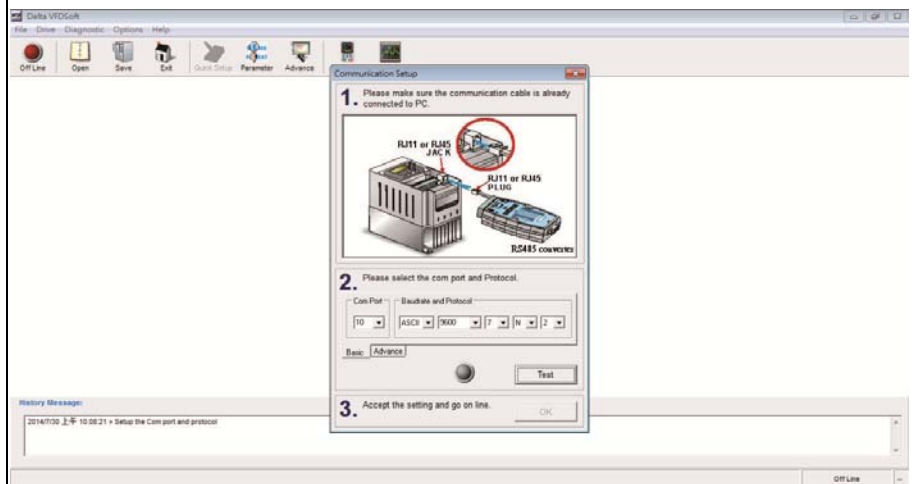

Start to upload parameters to VFDSolk

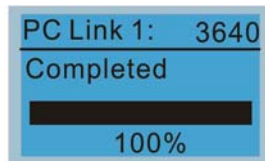

Uploading parameter is completed

Before using the user defined starting screen and user defined main screen, the starting screen setup and the main screen setup have to be preset as user defined.

If the user defined page is not downloaded to KPC-CC02, the starting screen and the main screen will be blank.

14. Application Selection List

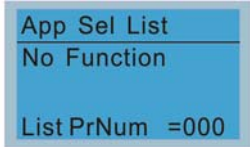

Select "Macro / User Define Macro" then set relevant parameters in "Application Selection List".

Application Selection List is the collection focusing on common used parameters for industry application, which is providing user the required parameter groups according to application; hence it also can change the value of the modified parameters to achieve a more rapid and convenient parameter settings.

Application Selection List operation associated charts is as below showing.

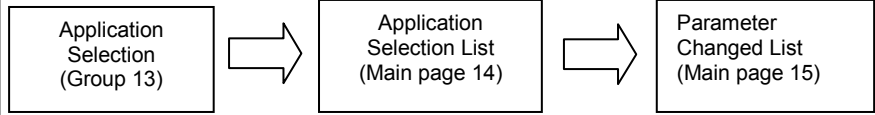

	Application Selection	Application Selection List	Parameter Changed List
Pr. location	Group 13 (parameter setting)	Main page 14	Main page 15
Function	Enter & edit parameter location	Set the value of parameter	Parameter changed list reference & Set the value of parameter
Operation	Set parameter 13-00=2~10(2~10:application selection;1:user parameter)	<ul style="list-style-type: none"> In application selection list · press ENTER 2 times it will show the related parameters. Use up/down key to select application selection list · then press ENTER to set parameter value. 	<ul style="list-style-type: none"> In parameter changed list · press ENTER 2 times it will enter the changed list.
Disable	Edit the value of parameter	Edit the location of parameter	Edit the location of parameter

Into the Application Selection page(during Pr.13-00≠0) · then press ENTER into Application Selection List · it will show the corresponding settings according to application list (13-00) · and then press ENTER key to see the user-defined or other application parameter groups,the parameter setting is the same as the general case, you can press the up/down key to select the parameters you want to change.

Operation Steps:

1. Choose "Parameter setting" group 13 then select the application which you want in "Application Selection List",the setting list is as below:

13-00=0 :Disabled (Macro function close)

- =1 :User Parameter
- =2 :Compressor
- =3 :Fan
- =4 :Pump
- =5~9 :Reserve
- =10 :AHU

2. After selecting application · Pr.13-01~99 will display the related

parameters (it will have a little number of parameters different according to the different kind of application list you select. There are 24 default parameters in compressor application; if you select Fan application, there are 33 default parameters.)

3. For example, if you select Compressor application:

13-00=2 (Compressor)

13-01~13-24 (Compressor related parameters)



4. The showing in Application Selection List is Compressor

List PrNum=024(Compressor related parameters)



Compressor			
No.	Pr.	Explanation	Settings
1	00-11	Control of Speed Mode	System Definition
2	00-16	Load Selection	System Definition
3	00-17	Carrier Frequency	Factory Setting
4	00- 0	Source of Master Frequency Command (AUTO)	System Definition
5	00-21	Source of the Operation Command (AUTO)	System Definition
	00-22	Stop Method	System Definition
7	00-23	Control of Motor Direction	System Definition
8	01-00	Max. Operation Frequency	Factory Setting
9	01-01	Output Frequency of Motor 1	Factory Setting
10	01-02	Output Voltage of Motor 1	Factory Setting
11	01-03	Mid-point Frequency 1 of Motor 1	Factory Setting
12	01-04	Mid-point Voltage 1 of Motor 1	Factory Setting
13	01-05	Mid-point Frequency 2 of Motor 1	Factory Setting
14	01-06	Mid-point Voltage 2 of Motor 1	Factory Setting
15	01-07	Min. Output Frequency of Motor 1	Factory Setting
16	01-08	Min. Output Voltage of Motor 1	Factory Setting
17	01-11	Output Frequency Lower Limit	System Definition
18	01-12	Accel. Time 1	System Definition
19	01-13	Decel Time 1	System Definition

20	03-00	Analog Input Selection (AVI)	System Definition
21	03-01	Analog Input Selection (ACI)	System Definition
22	05-01	Full-load Current of Induction Motor 1(A)	Factory Setting
23	05-03	Rated Speed of Induction Motor 1 (rpm)	Factory Setting
24	05-04	Pole Number of Induction Motor 1	Factory Setting

5. When user select "Application Selection List" (e.g. Compressor), drive will show the related parameters in above table according to user 's selection, the settings content can be divided into "System Definition" and "Factory Setting". "System Definition" means drive will load the commonly used value settings in compressor application, "Factory Setting" means the default setting of drive. User can edit the parameter value no matter the setting is "System Definition" or "Factory Setting".

6. User can edit or change the parameter space(max. to 99, Pr.13-01~99) for Compressor in "Application Selection List", if you want to add 2 spaces after default parameter(Pr.13-01~24) for Compressor, it needs to select No.25 & 26 parameter space(Pr.13-25 and Pr.13-26) then enter 7.11(Pr.07-11) and 7.33(Pr.07-33) separately (Please pay a special attention, if you key in 0.00 in any position, it will be identified as the final parameters of this application parameter) · after changing the Application Selection List will have 26 parameter locations for Compressor can be selected.

No.	Pr.	Explanation	Setting
25	07-11	Number of Times of Auto Restart After Fault	System Definition
26	07-33	Auto restart interval of Fault	System Definition

Please follow the setting process below to set the User Defined application selection (Pr.13-00=1):

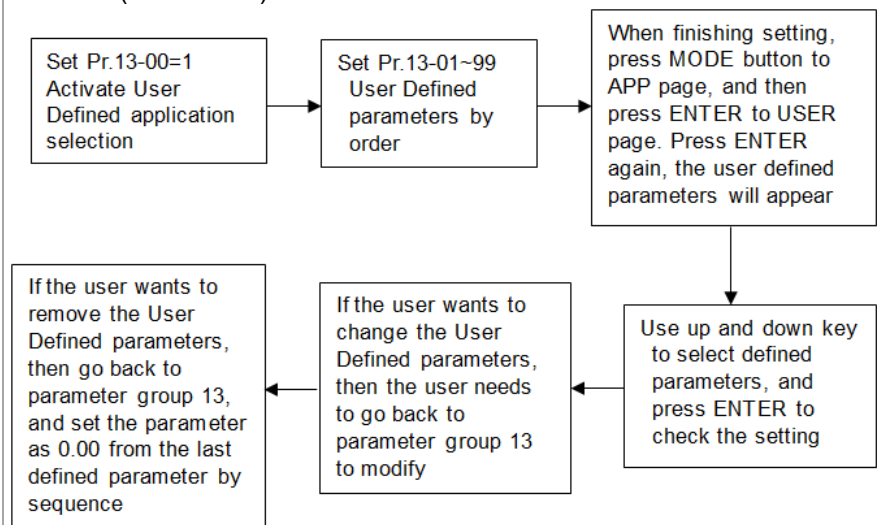

If user select User Parameter (Pr.13-00=1), but there is no any definition for parameter location (Pr.13-01~99), it is not allow to check in Application Selection List page, but also cannot enter next page when press ENTER.If

If there has User Parameter settings, when back to Application Selection List page, press ENTER it will display the current application as " User Parameter ", then press ENTER again, it will appear the previous setting parameters.

Example : Select Fan Application

	<p>In Pr. Setup page · use▲▼ key to select 13 : Application Selection List · then press </p>
	<p>Use▲▼key to select 00 : Application Selection List · then press </p>
	<p>It is showing 13-00 parameter value=0(no function) ,use▲▼ key to adjust the number to 3: Fan · then press to load the relevant parameters of the fan application.</p>
	<p>Back to main page · use ▲▼ key to select 14 : Application Selection List · then press </p>
	<p>It shows there are 33 default parameters setting in fan application · then press </p>

Fan			
No.	Pr.	Explanation	Settings
1	00-11	Control of Speed Mode	System Definit on
2	00-16	Load Selection	System Definition
3	00-17	Carrier Frequency	Factory Setting
4	00-20	Source of Master Frequency Command (AUTO)	System Definition
5	00-21	Source of the Operation Command (AUTO)	System Definition
6	00-22	Stop Method	System Defin tion
7	00-23	Control of Motor Direction	System Definition
8	00-30	Source of the Master Frequency Command (HAND)	System Definition

9	00-31	Source of the Operation Command (HAND)	System Definition
10	1-00	Max. Operation Frequency	Factory Setting
11	01 01	Output Frequency of Motor 1	Factory Setting
12	01-02	Output Voltage of Motor 1	Factory Setting
1	01-03	Mid-point Frequency 1 of Motor 1	Factory Setting
14	01-04	Mid-point Voltage 1 of Motor 1	Factory Setting
15	01-05	Mid-point Frequency 2 of Motor 1	Factory Setting
16	01-06	Mid-point Voltage 2 of Motor 1	Factory Setting
17	01-07	Min. Output Frequency of Motor 1	Factory Setting
18	01-08	Min. Output Voltage of Motor 1	Factory Setting
19	01-10	Output Frequency Upper Limit	System Definition
20	01-11	Output Frequency Lower Limit	System Definition
21	01-12	Accel. Time 1	System Definition
22	01-13	Decel Time 1	System Definition
23	01-43	V/F Curve Selection	System Definition
24	02-05	Multi-function Input Command 5 (MI5)	System Definition
25	03-00	Analog Input Selection (AVI)	System Definition
26	03-01	Analog Input Selection (ACI)	System Definition
27	03-28	AVI1 Selection	System Definition
28	03-29	ACI Selection	System Definition
29	03-31	AFM2 Output Selection	System Definition
30	03-50	Analog Input Curve Selection	System Definition
31	07-06	Restart after Momentary Power Loss	System Definition
32	07-11	Number of Times of Auto Restart After Fault	System Definition
33	07-33	Auto restart internal of Fault	System Definition

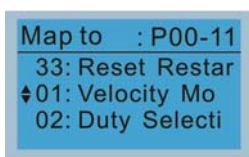

Use▲▼ key to select parameter from 01~33 · after selecting the parameter you want to change(e.g. 01 : Control of Speed Mode) · then press .

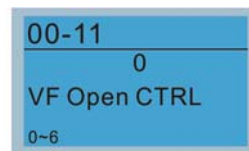

It is showing 00-11 parameter value=0(VF(IM V/F control)) ,use▲▼ key to adjust the number to 2 SVC(IM/PM Sensorless vector control) · then press , it will change to SVC control.

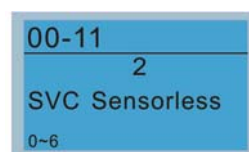

There are 33 parameters in fan application · if you want to adjust or add parameters · please select Pr. 13-01~33 for parameter adjustment; or select Pr. 13-34~99 for new parameter setting in parameter group 13.

e.g. adjust 13-01 Application Parameter 1 value from 0.11(00-11 Control of Speed Mode) to 0.02(00-02 Parameter Reset).

13-App Sel List

◆00: App Sel List
01: App Par 1
02: App Par 2

13-01

0.1
App Par 1
0.00~655.35 ADD

Use▲▼ key to select 01 : Application Parameter 1 · then press **ENTER** to adjust parameter value.

13-01

0.02
App Par 1
0.00~655.35 ADD

Use▲▼ key to adjust the parameter 0.02 · then press **ENTER**.

- In Fan application, when adding new parameter space (Pr.13-34~99) · it needs to pay attention that if you key in 0.00 in any position, it will be identified as the final parameters of this application parameter.
- In addition, whether the user has edited or changed the Application Selection List, when switching to other application, it will load the initial value of this application definition.
- Application Selection List needs to set in parameter group 13. Set Pr.13-00≠0, the Application Selection List is enable.
- Set Pr.13-00=1, User Parameter is enable.
- User sets parameter Pr.13-01 ~ 99 according to the function demand, when the value is 0.00, it means there is no preset or user defined parameters. Select the desired parameter location then press ENTER, the settings will record to parameters Pr.13-01 ~ 99.
- The settings of user parameter is the same as general parameter, use the up /down, left and right keys to speed up the setting, please note that the read-only parameters can not be set.
- If the changed parameter settings need to change again, it needs to back Pr.13-01~99 for modification.
- If you want to remove the parameter when the parameter has been set, you must to remove from the last parameter. For example, if you set 5 parameters from Pr.13-01 to Pr.13-05, if you want to remove Pr.13-02; it needs to remove from Pr.13-05, Pr.13-04 and Pr.13-03 in order.

15. Parameter Changed List

<div data-bbox="177 185 424 331" style="border: 1px solid black; padding: 5px; margin-bottom: 10px;"> <p>Changed List Changed Pr</p> <hr/> <p>List PrNum =000</p> </div> <p>User can review Changed List to check the parameter that is different from default setting.</p>	<p>Parameter changed list will record the parameter change from user (not limited in parameter setting record list)</p>	
	<div data-bbox="608 280 855 425" style="border: 1px solid black; padding: 5px;"> <p>Menu</p> <p>14: App Sel List</p> <p>◆15: Changed List</p> <p>1: Pr Setup</p> </div>	<p>In Menu page · use▲▼ key to select 15 : Changed List · then press ENTER.</p>
	<div data-bbox="608 472 855 618" style="border: 1px solid black; padding: 5px;"> <p>Chaned List Changed Pr</p> <hr/> <p>List PrNum =029</p> </div>	<p>It will show the parameter change history · there are total 29 records change parameters · then press ENTER.</p>
	<div data-bbox="608 665 855 810" style="border: 1px solid black; padding: 5px;"> <p>Map to : P00-17</p> <p>29: Circulative</p> <p>◆01: Carry Frequ</p> <p>02: Source of FR</p> </div>	<p>Use ▲▼ key to check and review parameter 01~29 · after selecting the parameter you want to change (e.g. 01 : Carrier Frequency) · then press ENTER · you can change the value of parameter directly.</p>

Other display

When fault occur, the menu will display:

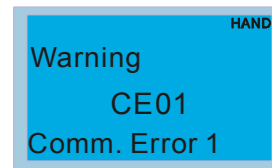
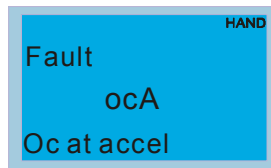

1. Press STOP/RESET button to reset the fault code. If still no response, please contact local distributor or return to the factory. To view the fault DC BUS voltage, output current and output voltage, press "MENU"→"Fault Record".
2. After resetting, if the screen returns to main page and shows no fault after pressing ESC, the fault is clear.
3. When fault or warning message appears, backlight LED will blinks until the fault or the warning is cleared.

Optional accessory: RJ45 Extension Lead for Digital Keypad

Part No.	Description
CBC-K3FT	RJ45 extension lead, 3 feet (approximately 0.9m)
CBC-K5FT	RJ45 extension lead, 5 feet (approximately 1.5 m)
CBC-K7FT	RJ45 extension lead, 7 feet (approximately 2.1 m)
CBC-K10FT	RJ45 extension lead, 10 feet (approximately 3 m)
CBC-K16FT	RJ45 extension lead, 16 feet (approximately 4.9 m)

Note: When you need to buy communication cables, buy non-shielded, 24 AWG, 4 twisted pair, 100 ohms communication cables.

10-3 TPEditor Installation Instruction

TPEditor can edit up to 256 HMI (Human-Machine Interface) pages with a total storage capacity of 256KB. Each page can edit 50 normal objects and 10 communication objects.

1) TPEditor: Setup & Basic Functions

1. Run TPEditor version 1.60 or above

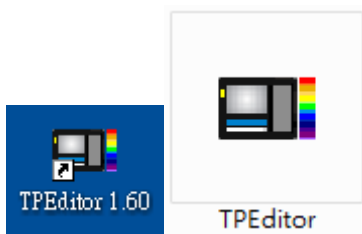

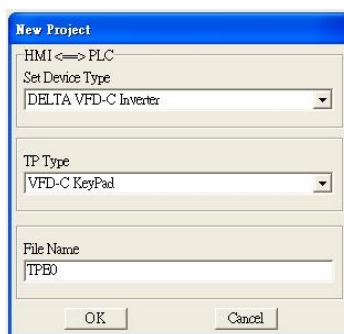

2. Go to File(F)→Click on New. The Window below will pop up. At the device type, click on the drop down menu and choose DELTA VFD-C Inverter. At the TP type, click on the drop down menu and choose VFD-C Keypad. As for File Name, enter TPE0. Now click on OK.



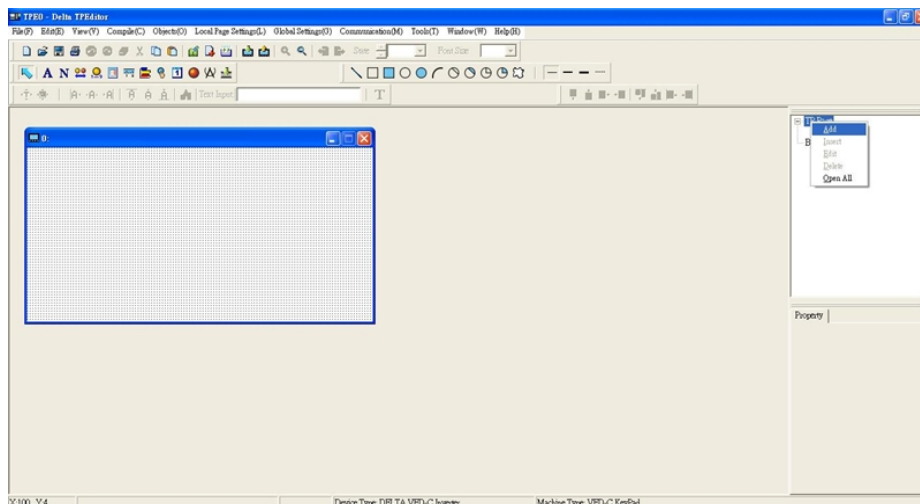

3. You are now at the designing page. Go to Edit (E)→Click on Add a New Page (A) or go to the TP page on the upper right side, right click once on TP page and choose Add to increase one more page for editing.

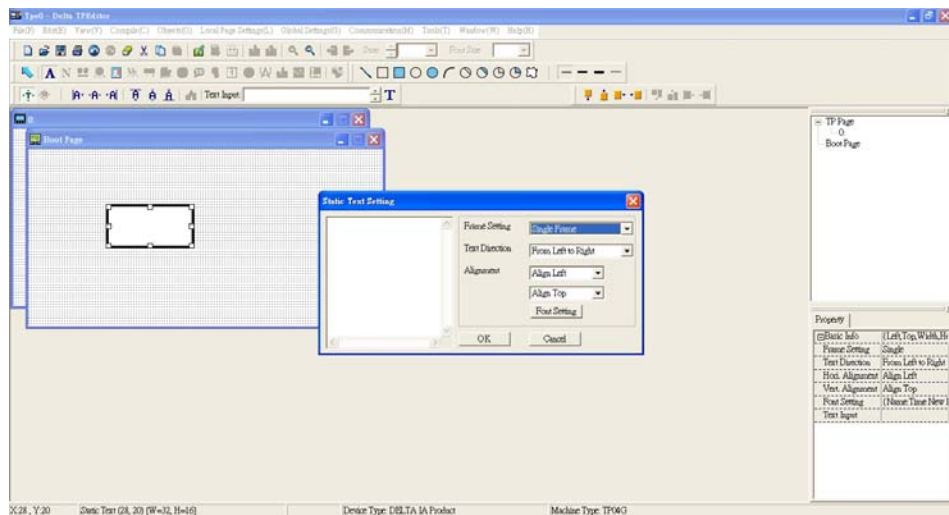

4. Edit Startup Page

5. Static Text  . Open a blank page, click once on this button  , and then double click on that blank page. The following windows will pop up.



6. Static Bitmap  → Open a blank page, then click once on this button  and then double click on that blank page. The following window will pop up.

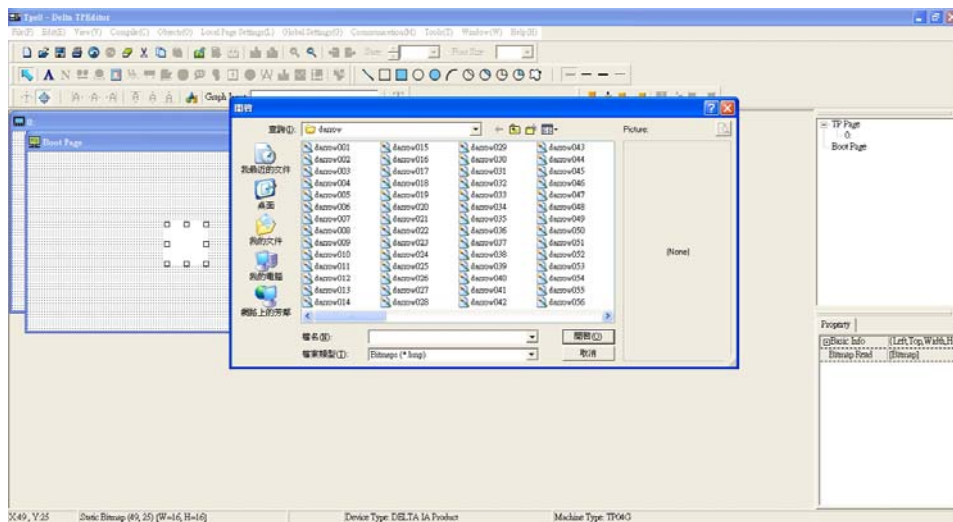

Please note that Static Bitmap setting support only images in BMP format. Now choose an image that you need and click open, then that image will appear in the Static Bitmap window.

7. Geometric Bitmap  → As shown in the picture on the left side, there are 11 kinds of geometric bitmap to choose. Open a new blank page then click once on a geometric bitmap icon that you need. Then drag that icon and enlarge it to the size that you need on that blank page.

- Finish editing the keypad starting screen and select **Communication>Input User Defined Keypad Starting Screen**.

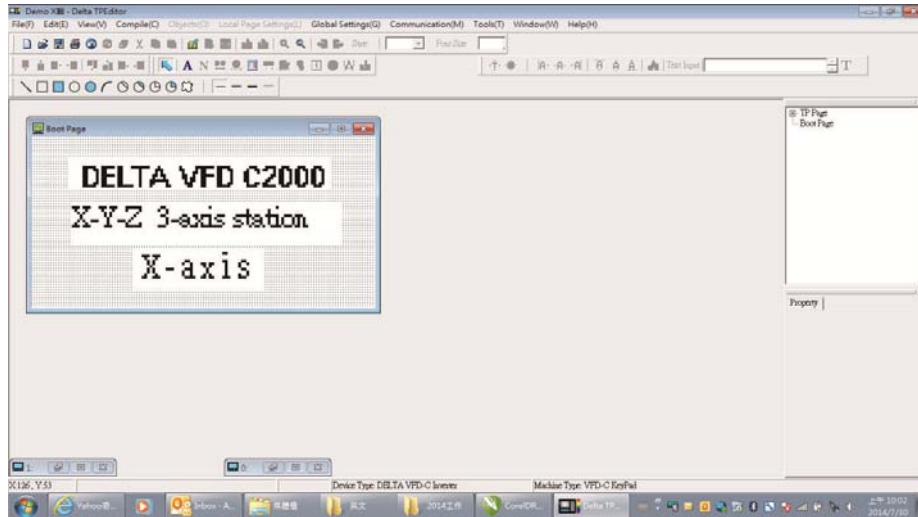

- Downloading setting: Go to Tool > Communication. Set up communication port and speed of IFD6530. There are five speed selections available: 9600 、 19200 、 38400 、 57600 and 115200 bps.
- Only three speed selections are available: 9600 bps, 19200 bps and 38400 bps. Select 通訊-> 自訂開機畫面輸入

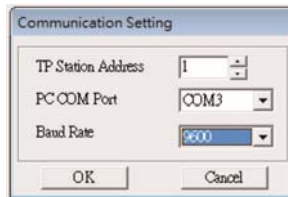

- When a dialogue box displayed on the screen asking to confirm writing or not, press buttons on the keypad to go to MENU, select PC LINK and then press ENTER and wait for few seconds. Then select YES on the screen to start downloading.

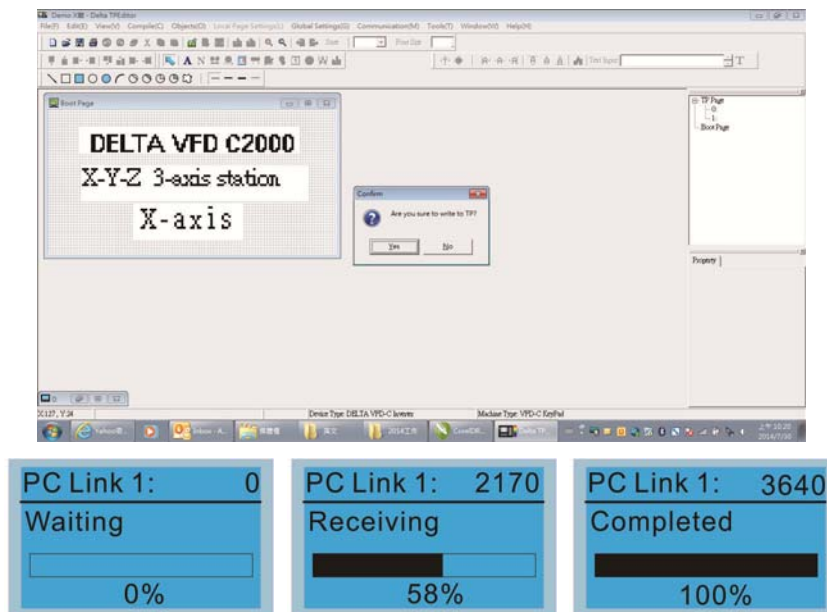

2) Edit Main Page & Example of Download

1. Go to editing page, select add one page or press the button ADD on the right hand side of the HMI page to increase number of pages to edit. This keypad currently support up to 256 pages.

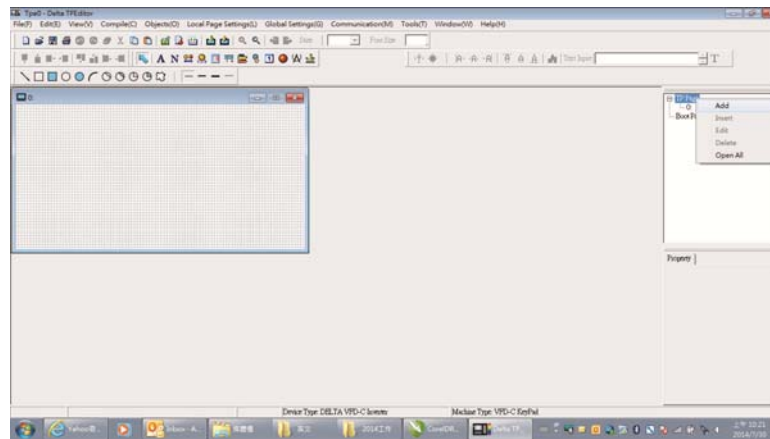

2. On the bottom right-hand corner of the HMI, click on a page number to edit or go to VIEW >HMI page to start editing main page. As shown in the image, the following objects are available. From left to right: Static Text, ASCII Display, Static Bitmap, Scale, Bar Graph, Button, Clock Display, Multi-state bit map, Units, Numeric Input and 11 geometric bitmaps and lines of different width. The application of Static Text, Static Bitmap, and geometric bitmap is the same as the editing startup page.



3. Numeric/ASCII Display: To add a Numeric/ASCII Display object to a screen, double click on the object to set up Related Devices, Frame Setting, Fonts and Alignment.

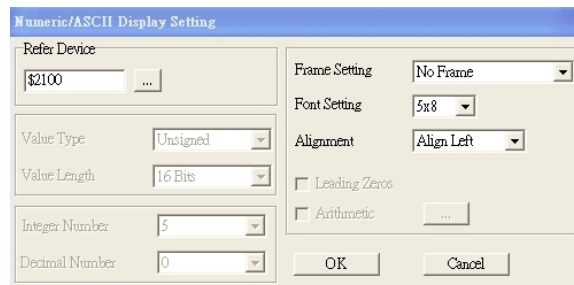

Related Device: Choose the VFD Communication Port that you need, if you want to read output frequency (H), set the VFD Communication Port to \$2202. For other values, please refer to ACMD Modbus Comm Address List.



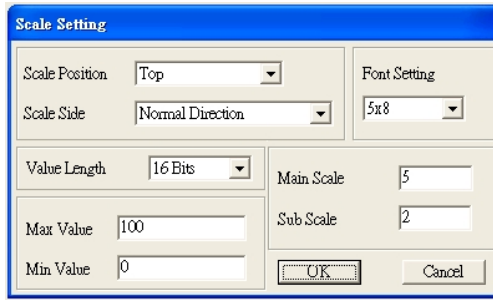

4. Scale Setting  : On the Tool Bar, click on this  for Scale Setting. You can also edit Scale Setting in the Property Window on the right hand side of your computer screen.

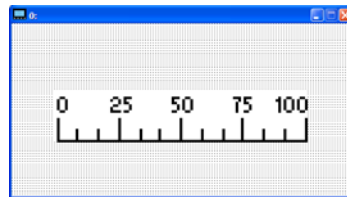

- Scale Position: Click on the drop down list to choose which position that you need to place a scale.
- Scale Side: Click on the drop down list to choose if you want to number your scale from smaller number to bigger number or from big to small. Click OK to accept this setting or click Cancel to abort.
- Font Setting: Click on the drop down list to choose the Font setting that you need then click OK to accept the setting or click Cancel to abort.
- Value Length: Click on the drop down to choose 16bits or 32 bits. Then click OK to accept the setting or click Cancel to abort.
- Main Scale & Sub Scale: In order to divide the whole scale into equal parts, key in the numbers of your choices for main scale and sub scale.
- Maximum value & Minimum Value are the numbers on the two ends of a scale. They can be negative numbers. But the values allowed to be input are limited by the length of value. For example, when the length of value is set to **be hexadecimal**, the maximum and the minimum value cannot be input as -4000.

Follow the Scale setting mentioned above; you will have a scale as shown below.



5. Bar Graph setting  :

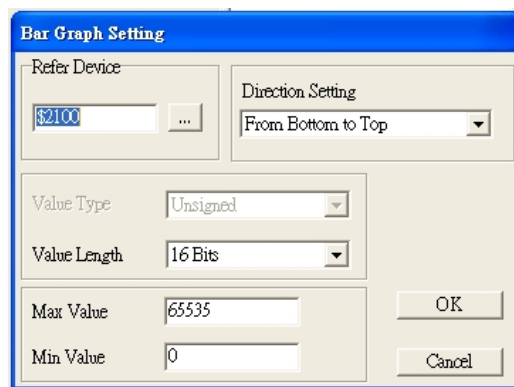

- Related Device: Choose the VFD Communication Port that you need.
- Direction Setting: Click on the drop down menu to choose one of the following directions: From Bottom to Top, From Top to Bottom, From Left to Right or From Right to Left.
- Maximum Value & Minimum Value: They define the range covered by the maximum value and minimum value. If a value is smaller than or equal to the minimum value, then the bar graph will be blank. If a value is bigger or equal to the maximum value, then the bar graph will be full. If a value is between minimum and maximum value, then the bar graph will be filled proportionally.

6. Button  : Currently this function only allows the Keypad to switch pages, other functions are not yet available. Text input function and Image inserted functions are not yet supported.

Double click on  to open set up window.

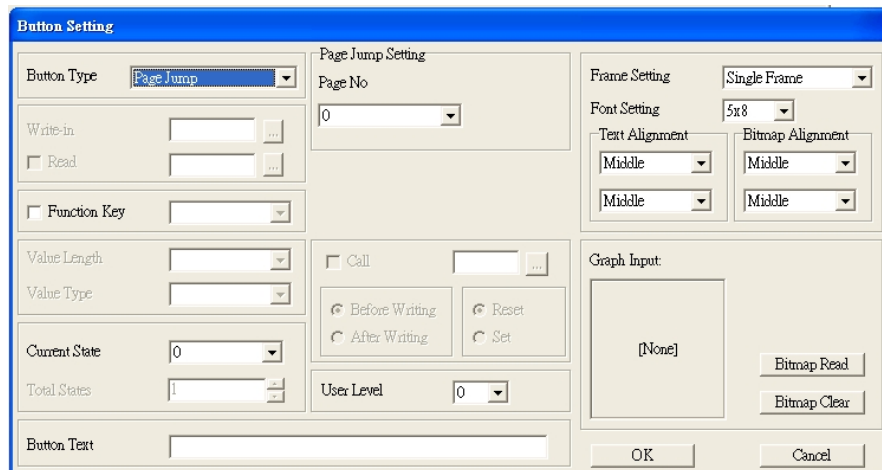

<Button Type> allows users set up buttons' functions. <Page Jump> and <Constant Setting> are the only two currently supported functions.

A [Page Jump] function setting

- Page Jump setting: After you choose the Page Jump function in the drop down list, you will see this Page Jump Setting Menu
- <Function Key> allows you to assign functions to the following keys on the KPC-CC02 keypad: F1, F2, F3, F4, Up, Down, Left and Right. Please note that the Up and Down keys are locked by TPEditor. These two keys cannot be programmed. If you want to program Up and Down keys, go to Tool→Function Key Settings (F)→Re-Define Up/Down Key(R).

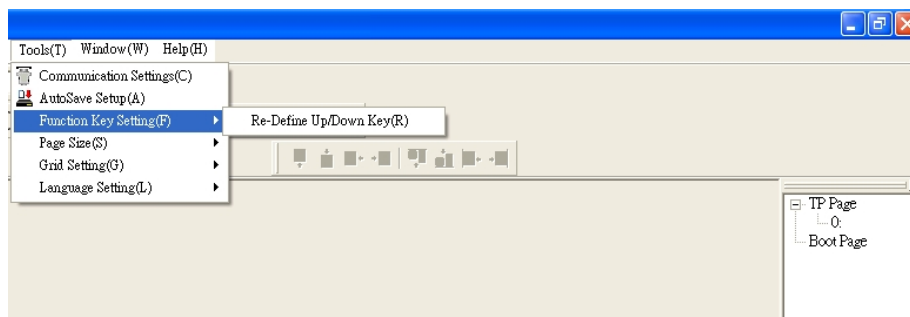

- Button Text: This function allows user to name buttons. For example, key in <Next Page> in the empty space, a button will have the wording <Next Page> displayed on it.

B [Constant setting] function

This function is to set up the memory address' value of the VFD or PLC. When pressing the <function button> set up in before, a value will be written to the memory address of the <Constant Setting>. This function can be used as initializing a variable.

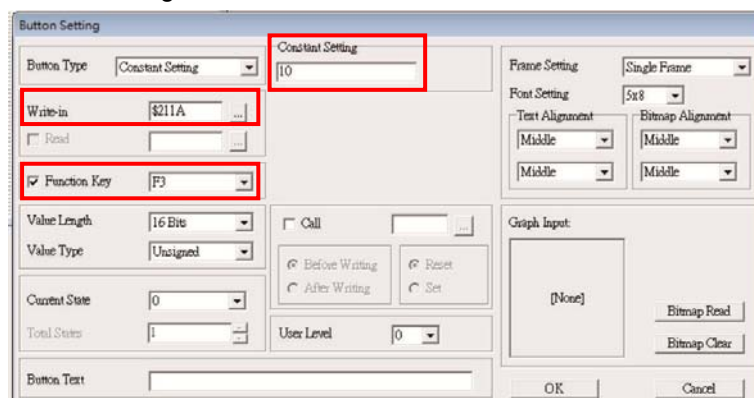

7. Clock Display Setting  : The setup window of the Clock Display is shown as the image below. Time, Day or Date can be displayed on the keypad. Open a new file and click once in that window, you will see the following In the clock display setting, you can choose to display Time, Day or Date on the Keypad. To adjust time, go to #9 on the Keypad's menu. You can also adjust Frame Setting, Font Setting and Alignment.

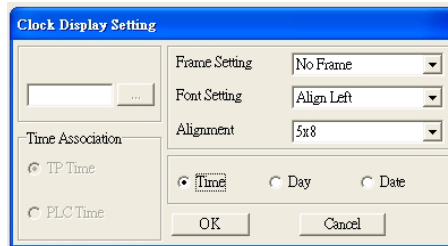

8. Multi-state bitmap  : The setup window of the multi-state is shown as the image below. This object reads the bit's property value of the PLC. It defines what image or wording is when this bit is 0 or when this bit is 1. Set the initial status to be 0 or 1 to define the displayed image or wording.

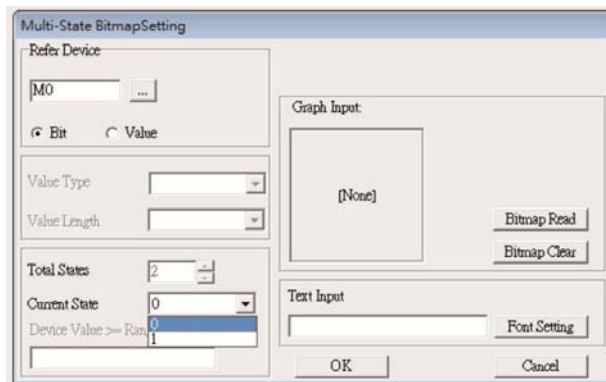

9. Unit Measurement  : Click once on this Button: Open a new file and double click on that window, you will see the following

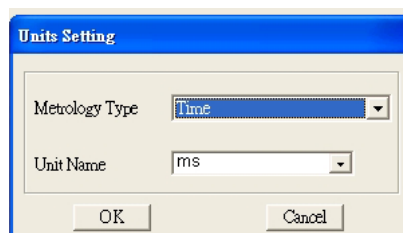

Choose from the drop down list the Metrology and the Unity Name that you need. As for Metrology, you have the following choices Length, Square Measure, Volume/Solid Measure, Weight, Speed, Time and Temperature. The unit name changes automatically when you change metrology type.

10. Numeric Input Setting 

This menu allows you to provide parameters or communication ports and to input numbers.

Click once on this button .

Open a new file and double click on that window, you will see the following:

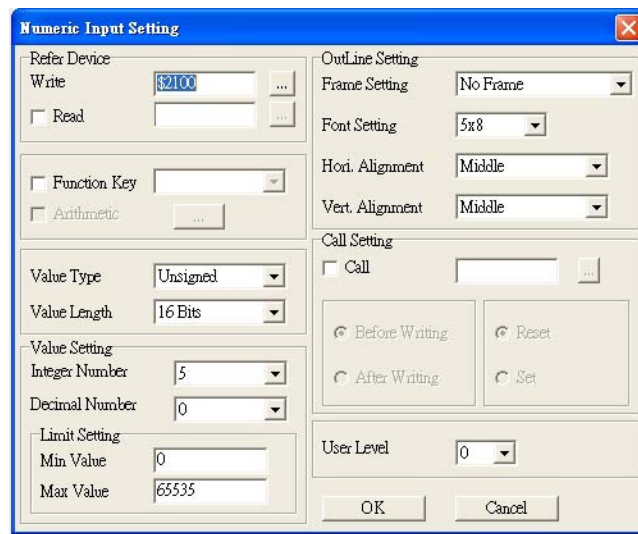

- Related Device: There are two blank spaces to fill in, one is <Write> and another one is <Read>. Input the numbers that you want to display and the corresponding numbers of a parameter and that of a communication port. For example, input 012C to Read and Write Parameter P01-44.
- Outline Setting: The Frame setting, Font setting, Vertical Alignment and Horizontal Alignment are the same as mentioned before. Click on the drop down menu and choose the setting that you need.
- Function key: The setting here allows you to program keys on the keypad. Press the key on the menu then the corresponding key on the keypad will start to blink, then press Enter to confirm the setting.
- Value Type & Value Length: These two factors influence the range of the Minimum and Maximum Value of the Limit Setting. Please note that the corresponding supporting values for C2000 have to be 16bits. The 32bits values are not supported.
- Value Setting: This part is set automatically by the keypad itself.
- Limit Setting: Input the range the security setting here.

For example, if you set Function Key as F1, Minimum Value as 0 and Maximum Value is 4, then press F1 on Keypad Then you can press Up and Down key on the keypad to increase or decrease the value. Press Enter Key on the keypad to confirm your setting. You can also go to parameter table 01-44 to verify if your input correctly the value.

11. Download TP Page: Press Up or Down key on the keypad until you reach #13 PC Link.

Then press Enter on the keypad and you will see the word "Waiting" on keypad's screen. Now choose a page that you have created then go to Communication (M)→Write to TP(W) to start downloading the page to the keypad

When you see the word Completed on the keypad's screen, that means the download is done. Then you can press ESC on the keypad to go back to the menu of the keypad.

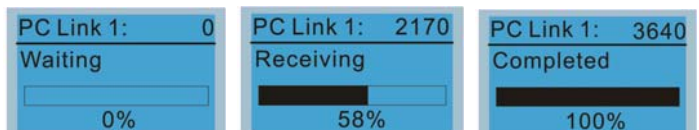
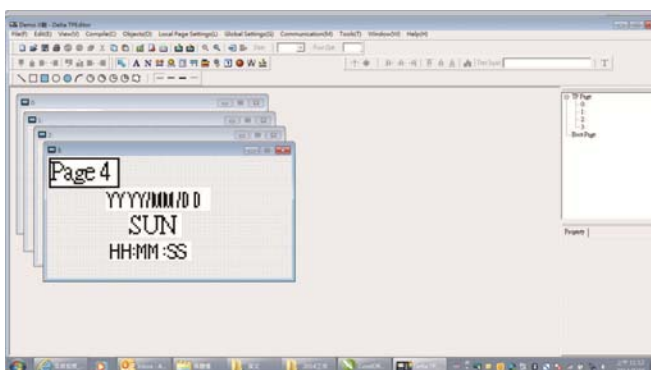

10-4 Digital Keypad KPC-CC02 Fault Codes and Descriptions

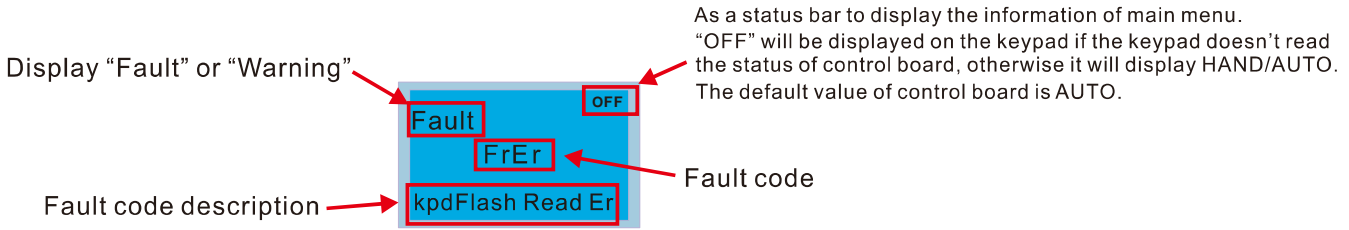

Fault Codes

LCM Display *	Description	Corrective Actions
	Keypad flash memory read error	An error has occurred on keypad's flash memory. <ol style="list-style-type: none"> 1. Press RESET on the keypad to clear errors. 2. Verify what kind of error has occurred on keypad's flash memory. 3. Shut down the system, wait for ten minutes, and then power on again the system. If none of the solution above works, contact your authorized local dealer.
	Keypad flash memory save error	An error has occurred on keypad's flash memory. <ol style="list-style-type: none"> 1. Press RESET on the keypad to clear errors. 2. Press RESET on the keypad to clear errors. 3. Shut down the system, wait for ten minutes, and then power on again the system. If none of the solution above works, contact your authorized local dealer.
	Keypad flash memory parameter error	Errors occurred on parameters of factory setting. It might be caused by firmware update. <ol style="list-style-type: none"> 1. Press RESET on the keypad to clear errors. 2. Verify if there's any problem on Flash IC. 3. Shut down the system, wait for ten minutes, and then power on again the system. If none of the solution above works, contact your local authorized dealer.
	Keypad flash memory when read AC drive data error	Keypad can't read any data sent from VFD. <ol style="list-style-type: none"> 1. Verify if the keypad is properly connect to the motor drive by a communication cable such as RJ-45. 2. Press RESET on the keypad to clear errors. 3. Shut down the system, wait for ten minutes, and then power on again the system. If none of the solution above works, contact your local authorized dealer.
	And then power on again the system.	A Serious error has occurred on keypad's CPU. <ol style="list-style-type: none"> 1. Verify if there's any problem on CPU clock? 2. Verify if there's any problem on Flash IC? 3. Verify if there's any problem on RTC IC? 4. Verify if the communication quality of the RS485 is good? 5. Shut down the system, wait for ten minutes, and then power on again the system. If none of the solution above works, contact your local authorized dealer.

Warning Codes

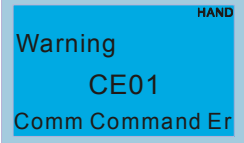
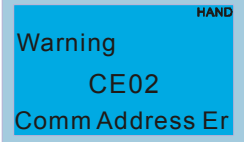
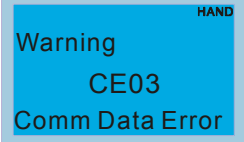
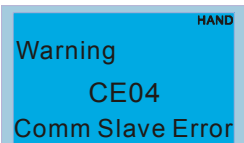
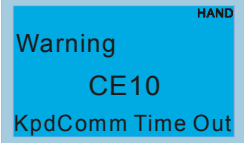
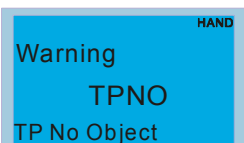
LCM Display *	Description	Corrective Actions
	Modbus function code error	Motor drive doesn't accept the communication command sent from keypad. 1. Verify if the keypad is properly connected to the motor drive on the communication contact by a communication cable such as RJ-45. 2. Press RESET on the keypad to clear errors. If none of the solution above works, contact your local authorized dealer.
	Modbus data address error	Motor drive doesn't accept keypad's communication address. 1. Verify if the keypad is properly connected to the motor drive on the communication contact by a communication cable such as RJ-45. 2. Press RESET on the keypad to clear errors. If none of the solution above works, contact your local authorized dealer.
	Modbus data value error	Motor drive doesn't accept the communication data sent from keypad. 1. Verify if the keypad is properly connected to the motor drive on the communication contact by a communication cable such as RJ-45. 2. Press RESET on the keypad to clear errors. If none of the solution above works, contact your local authorized dealer.
	Modbus slave drive error	Motor drive cannot process the communication command sent from keypad. 1. Verify if the keypad is properly connected to the motor drive on the communication contact by a communication cable such as RJ-45. 2. Press RESET on the keypad to clear errors. 3. Shut down the system, wait for ten minutes, and then power on again the system. If none of the solution above works, contact your local authorized dealer.
	Modbus transmission time-Out	Motor drive doesn't respond to the communication command sent from keypad. 1. Verify if the keypad is properly connected to the motor drive on the communication contact by a communication cable such as RJ-45. 2. Press RESET on the keypad to clear errors. 3. Shut down the system, wait for ten minutes, and then power on again the system. If none of the solution above works, contact your local authorized dealer.
	Object not supported by TP Editor	Keypad's TP Editor uses unsupported object or Drive series. 1. Verify how the TP Editor should use that object. Delete unsupported object and unsupported setting. 2. Reedit the TP editor and then download it. 3. Make sure the the Drive series support TP functions. If it didn't, the main page will display default. If none of the solution above works, contact your local authorized dealer.

 **NOTE** The warning code which shows as “CExx” only occurs when the communication problem between the drive and keypad, and it's nothing to do with the drive and other device. Be noted that the warning code description to judge the cause of error if “CExx” occurs.

File Copy Setting Fault Description:

These faults will happen when KPC-CC02 cannot perform the command after clicking the Enter button in copy function.

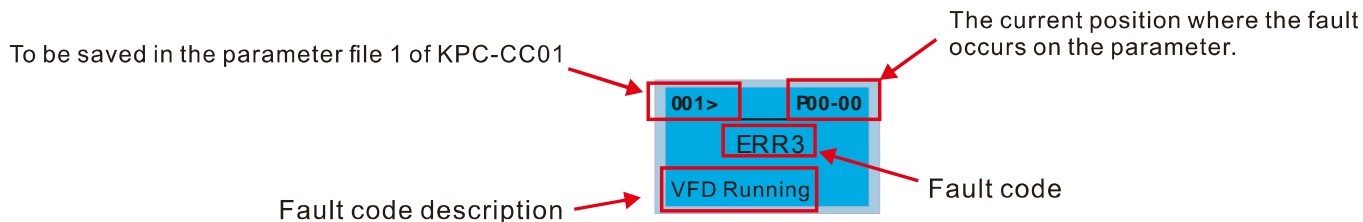

LCM Display *	Description	Corrective Actions
<div style="border: 1px solid black; padding: 5px;"> <div style="display: flex; justify-content: space-between; border-bottom: 1px solid black;"> 001> P00-00 </div> <div style="text-align: center; font-weight: bold; font-size: 1.2em;">ERR1</div> <div style="text-align: center; font-weight: bold;">Read Only</div> </div>	Parameter and file are read only	The property of the parameter/file is read-only and cannot be written to. 1. Verify the specification on the user manual. If the solution above doesn't work, contact your local authorized dealer.
<div style="border: 1px solid black; padding: 5px;"> <div style="display: flex; justify-content: space-between; border-bottom: 1px solid black;"> 001> P00-00 </div> <div style="text-align: center; font-weight: bold; font-size: 1.2em;">ERR2</div> <div style="text-align: center; font-weight: bold;">Write Fail</div> </div>	Fail to write parameter and file	An error occurred while write to a parameter/file. 1. Verify if there's any problem on the Flash IC. 2. Shut down the system, wait for ten minutes, and then power on again the system. If none of the solution above work, contact your local authorized dealer.
<div style="border: 1px solid black; padding: 5px;"> <div style="display: flex; justify-content: space-between; border-bottom: 1px solid black;"> 001> P00-00 </div> <div style="text-align: center; font-weight: bold; font-size: 1.2em;">ERR3</div> <div style="text-align: center; font-weight: bold;">VFD Running</div> </div>	AC drive is in operating status	A setting cannot be made while motor drive is in operation. 1. Verify if the drive is not in operation. If the solution above doesn't work, contact your local authorized dealer.
<div style="border: 1px solid black; padding: 5px;"> <div style="display: flex; justify-content: space-between; border-bottom: 1px solid black;"> 001> P00-00 </div> <div style="text-align: center; font-weight: bold; font-size: 1.2em;">ERR4</div> <div style="text-align: center; font-weight: bold;">Pr Lock</div> </div>	AC drive parameter is locked	A setting cannot be made because a parameter is locked. 1. Verify if the parameter is locked or not. If it is locked, unlock it and try to set up the parameter again. If the solution above doesn't work, contact your local authorized dealer.
<div style="border: 1px solid black; padding: 5px;"> <div style="display: flex; justify-content: space-between; border-bottom: 1px solid black;"> 001> P00-00 </div> <div style="text-align: center; font-weight: bold; font-size: 1.2em;">ERR5</div> <div style="text-align: center; font-weight: bold;">Pr Changing</div> </div>	AC drive parameter changing	A setting cannot be made because a parameter is being modified. 1. Verify if the parameter is being modified. If it is not being modified, try to set up that parameter again. If the solution above doesn't work, contact your local authorized dealer.
<div style="border: 1px solid black; padding: 5px;"> <div style="display: flex; justify-content: space-between; border-bottom: 1px solid black;"> 001> P00-00 </div> <div style="text-align: center; font-weight: bold; font-size: 1.2em;">ERR6</div> <div style="text-align: center; font-weight: bold;">Fault Code</div> </div>	Fault code	A setting cannot be made because an error has occurred on the motor drive. 1. Verify if there's any error occurred on the motor drive. If there isn't any error, try to make the setting again. If the solution above doesn't work, contact your local authorized dealer.
<div style="border: 1px solid black; padding: 5px;"> <div style="display: flex; justify-content: space-between; border-bottom: 1px solid black;"> 001> P00-00 </div> <div style="text-align: center; font-weight: bold; font-size: 1.2em;">ERR7</div> <div style="text-align: center; font-weight: bold;">Warning Code</div> </div>	Warning code	A setting cannot be made because of a warning message given to the motor drive. 1. Verify if there's any warning message given to the motor drive. If the solution above doesn't work, contact your local authorized dealer.
<div style="border: 1px solid black; padding: 5px;"> <div style="display: flex; justify-content: space-between; border-bottom: 1px solid black;"> 001> P00-00 </div> <div style="text-align: center; font-weight: bold; font-size: 1.2em;">ERR8</div> <div style="text-align: center; font-weight: bold;">Type Dismatch</div> </div>	File type dismatch	Data need to be copied are not same type, so the setting cannot be made. 1. Verify if the products' serial numbers need to be copied fall in the category. If they are in the same category, try to make the setting again. If the solution above doesn't work, contact your authorized dealer.

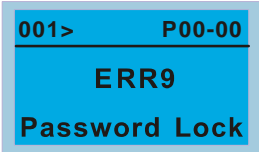
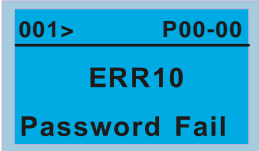
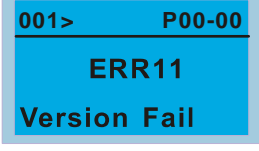
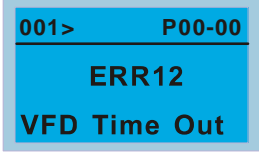
LCM Display *	Description	Corrective Actions
	File is locked with password	<p>A setting cannot be made, because some data are locked.</p> <ol style="list-style-type: none"> 1. Verify if the data are unlocked or able to be unlocked. If the data are unlocked, try to make the setting again. 2. Shut down the system, wait for ten minutes, and then power on again the system. <p>If none of the solution above works, contact your local authorized dealer.</p>
	File version mismatch	<p>A setting cannot be made because the password is incorrect.</p> <ol style="list-style-type: none"> 1. Verify if the password is correct. If the password is correct, try to make the setting again. 2. Shut down the system, wait for ten minutes, and then power on again the system. <p>If none of the solution above works, contact your local authorized dealer.</p>
	AC drive copy function time-out	<p>A setting cannot be made, because the version of the data is incorrect.</p> <ol style="list-style-type: none"> 1. Verify if the version of the data matches the motor drive. If it matches, try to make the setting again. <p>If none of the solution above works, contact your local authorized dealer.</p>
	Other keypad error	<p>A setting cannot be made, because data copying timeout expired.</p> <ol style="list-style-type: none"> 1. Redo data copying. 2. Verify if copying data is authorized. If it is authorized, try again to copy data. 3. Shut down the system, wait for ten minutes, and then power on again the system. <p>If none of the solution above works, contact your local authorized dealer.</p>

※ The content in this chapter only applies on V1.01 and above of KPC-CC02 keypad.

10-5 Functions not supported when using TPEditor with KPC-CC02

1. Local Page Setting and Global Setting functions are not supported.



2. [Communication]→[Read from TP] functions are not supported.

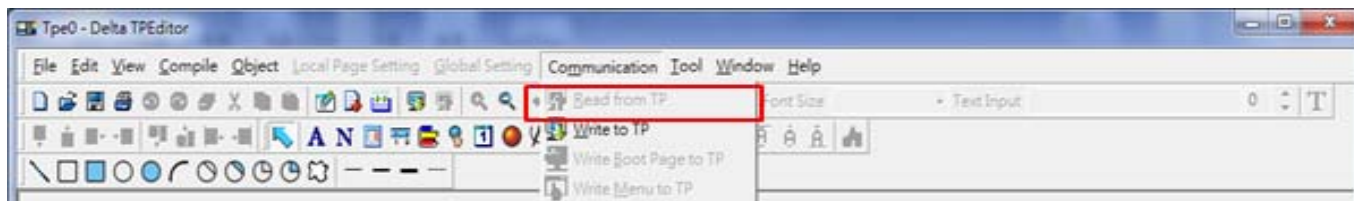

3. In RTC Display Setting, the Refer Device cannot be modified.

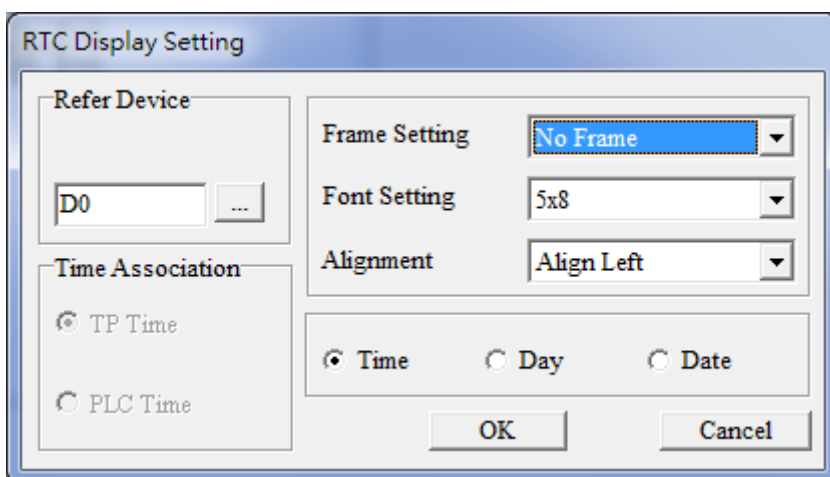



Chapter 11 Summary of Parameter Settings

This chapter provides summary of parameter settings for user to gather the parameter setting ranges, factory settings and set parameters. The parameters can be set, changed and reset by the digital keypad.

NOTE

- 1) : the parameter can be set during operation
- 2) For more detail on parameters, please refer to Ch12 Description of Parameter Settings.

00 Drive Parameters

Pr.	Explanation	Settings	Factory Setting
00-00	Identity Code of the AC Motor Drive	5 : 460V · 1HP (0.75kW) 7 : 460V · 2HP (1.5kW) 9 : 460V · 3HP (2.2kW) 11 : 460V · 5HP (3.7kW) 13 : 460V · 7.5HP (5.5kW) 15 : 460V · 10HP (7.5kW) 17 : 460V · 15HP (11kW) 19 : 460V · 20HP (15kW) 21 : 460V · 25HP (18.5kW) 23 : 460V · 30HP (22kW) 25 : 460V · 40HP (30kW) 27 : 460V · 50HP (37kW) 29 : 460V · 60HP (45kW) 31 : 460V · 75HP (55kW) 33 : 460V · 100HP (75kW) 35 : 460V · 125HP (90kW) 93 : 460V · 5.5HP (4.0kW)	Read only
00-01	Display AC Motor Drive Rated Current	Display by models	Read only
00-02	Parameter Reset	0: No function 1: Parameter write protect 5: Reset KWH display to 0 6: Reset PLC (including CANopen Master Index) 7: Reset CANopen Index (Slave) 9: All parameters are reset to factory settings(base frequency is 50Hz) 10: All parameters are reset to factory settings (base frequency is 60Hz)	0
 00-03	Start-up Display Selection	0: F (frequency command) 1: H (output frequency) 2: U (multi-function display, see Pr.00-04) 3: A (output current)	0
 00-04	Content of Multi-function Display	0: Display output current (A) (Unit: Amps) 1: Display counter value (c) (Unit: CNT) 2: Display actual output frequency (H.) (Unit: Hz) 3: Display DC-BUS voltage (v) (Unit: Vdc) 4: Display output voltage (E) (Unit: Vac) 5: Display output power angle (n) (Unit: deg) 6: Display output power in kW (P) (Unit: kW) 7: Display actual motor speed rpm (r) (Unit: rpm) 8: Reserved 9: Reserved 10: Display PID feedback (b) (Unit: %) 11: Display AVI in % (1.) (Unit: %) 12: Display ACI in % (2.) (Unit: %)	3

Pr.	Explanation	Settings	Factory Setting			
		13: Display AUI in % (3.) (Unit: %) 14: Display the temperature of IGBT in °C (i.) (Unit: °C) 15: Display the temperature of capacitance in °C (c.) (Unit: °C) 16: The status of digital input (ON/OFF) (i) 17: The status of digital output (ON/OFF) (o) 18: Multi-step speed (S) 19: The corresponding CPU pin status of digital input (d) 20: The corresponding CPU pin status of digital output (0.) 21~24: Reserved 25: Overload count (0.00~100.00%) (h.) (Unit: %) 26: Ground Fault GFF(G.) (Unit: %) 27: DC Bus voltage ripple (Unit: Vdc) (r.) 28: Display PLC data D1043 (C) 29: Reserved 30: Display output of user defined (U) 31: Display Pr.00-05 user Gain(K) 32: Reserved 33: Reserved 34: Operation speed of fan (F.) (Unit: %) 35: Reserved 36: Present operating carrier frequency of drive (Hz) (J.) 37: Reserved 38: Display drive status (6.) 39: Reserved 40: Reserved 41: KWH display (J) (Unit: kWH) 42: PID Reference (L) (Unit: %) 43: PID offset (o.) (Unit: %) 44: PID Output Fcmd(Hz) (b.) (Unit: Hz) 45: Hardware ID (0)				
↗	00-05	Coefficient Gain in Actual Output Frequency	0~160.00	1.00		
	00-06	Software Version	Read only	##		
↗	00-07	Parameter Protection Password Input	0~65535 0~4: the times of password attempts	0		
↗	00-08	Parameter Protection Password Setting	0 ~ 65535 0: No password protection / password is entered correctly (Pr00-07) 1: Parameter is locked	0		
	00-09	Reserved				
	00-10	Reserved				
	00-11	Control of Speed Mode	0: VF (IM V/f control) 2: SVC(IM/PM Sensorless vector control)	0		
	00-12 ~ 00-15	Reserved				
↗	00-16	Load Selection	0: Light load 1: Normal load	0		
	00-17	Carrier Frequency	1-25HP	2~15KHz	4	
				30-100HP	2~10KHz	4
				125HP	2~9KHz	4
	00-18	Reserved				
	00-19	PLC Command Mask	Bit 0: Control command by PLC force control Bit 1: Frequency command by PLC force control	0		

Pr.	Explanation	Settings	Factory Setting
		Bit 2: Reserved Bit 3: Reserved	
00-20	Source of Master Frequency Command (AUTO)	0: Digital keypad 1: RS-485 serial communication 2: External analog input (Pr.03-00) 3: External UP/DOWN terminal 6: CANopen communication card 8: Communication card (no CANopen card)	0
00-21	Source of the Operation Command (AUTO)	0: Digital keypad 1: External terminals. Keypad STOP disabled. 2: RS-485 serial communication. Keypad STOP disabled. 3: CANopen communication card 5: Communication card (no CANopen card)	0
↗ 00-22	Stop Method	0: Ramp to stop 1: Coast to stop	0
↗ 00-23	Control of Motor Direction	0: Enable forward/reverse 1: Reverse disable 2: Forward disable	0
00-24	Memory of Digital Operator (Keypad) Frequency Command	Read only	Read only
↗ 00-25	User Defined Characteristics	Bit 0~3: user defined decimal place 0000b: no decimal place 0001b: one decimal place 0010b: two decimal place 0011b: three decimal place Bit 4~15: user define on unit 000xh: Hz 001xh: rpm 002xh: % 003xh: kg 004xh: m/s 005xh: kW 006xh: HP 007xh: ppm 008xh: 1/m 009xh: kg/s 00Axh: kg/m 00Bxh: kg/h 00Cxh: l _l /s 00Dxh: l _l /m 00Exh: l _l /h 00F _l xh: ft/s 010xh: ft/m 011xh: m 012xh: ft 013xh: degC 014xh: degF 015xh: mbar 016xh: bar 017xh: Pa 018xh: kPa 019xh: mWG 01Axh: inWG 01Bxh: ftWG 01Cxh: psi 01Dxh: atm 01Exh: L/s 01F _l xh: L/m 020xh: L/h 021xh: m ³ /s 022xh: m ³ /h	0

Pr.	Explanation	Settings	Factory Setting
		023xh: GPM 024xh: CFM	
00-26	Max. User Defined Value	When Pr.00-25 bit 0~3=0000B Setting: 1~65535 0: Disable When Pr.00-25 bit 0~3=0000B Setting: 0.1~6553.5 Factory Setting: 0.0 When Pr.00-25 bit 0~3=0000B Setting: 0.01~655.35 Factory Setting: 0.00 When Pr.00-25 bit 0~3=0000B Setting: 0.001~65.535 Factory Setting: 0.000	0
00-27	User Defined Value	Read only	Read Only
00-28	Switch from AUTO control to HAND (MANUAL) control	bit0: Sleep mode control bit 0: Disable sleep mode 1: Same sleep mode as in AUTO control bit1: Unit displaying control bit 0: Change the displayed unit to Hz 1: Same unit displaying as in AUTO control bit2: PID control bit 0: Disable PID mode 1: Same PID mode as in AUTO control bit3: Source of frequency control bit 0: Source of the frequency depends on the parameter setting. If the multi-speed setting is enabled, the multi-speed has the priority. 1: Source of frequency follows the setting of Pr00-30, regardless the multi-speed setting.	0
00-29	LOCAL/REMOTE Selection	0: Standard HOA function 1: Switching Local/Remote, the drive stops 2: Switching Local/Remote, the drive runs as the REMOTE setting for frequency and operation status 3: Switching Local/Remote, the drive runs as the LOCAL setting for frequency and operation status 4: Switching Local/Remote, the drive runs as LOCAL setting when switch to Local and runs as REMOTE setting when switch to Remote for frequency and operation status.	0
00-30	Source of the Master Frequency Command (HAND)	0: Digital keypad 1: RS-485 serial communication 2: External analog input (Pr.03-00) 3: External UP/DOWN terminal 6: CANopen communication card 8: Communication card (no CANopen card)	0
00-31	Source of the Operation Command (HAND)	0: Digital keypad 1: External terminals. Keypad STOP disabled. 2: RS-485 serial communication. Keypad STOP disabled. 3: CANopen communication card 5: Communication card (not include CANopen card)	0

Pr.	Explanation	Settings	Factory Setting
↗ 00-32	Digital Keypad STOP Function	0: STOP key disable 1: STOP key enable	0
00-33 ~ 00-47	Reserved		
↗ 00-48	Display Filter Time (Current)	0.001~65.535 sec	0.100
↗ 00-49	Display Filter Time (Keypad)	0.001~65.535 sec	0.100
00-50	Software Version (date)	Read only	#####
00-51 ~ 00-60	Reserved		

01 Basic Parameters

Pr.	Explanation	Settings	Factory Setting
✓ 01-00	Max. Operation Frequency	0.75~75kW (1~100HP): 50.00~599.00Hz 90kW (125HP): 0.00~400.00Hz	60.00/ 50.00
01-01	Output Frequency of Motor 1	0.00~599.00Hz	60.00/ 50.00
01-02	Output Voltage of Motor 1	0.0V~510.0V	400.0
01-03	Mid-point Frequency 1 of Motor 1	0.00~599.00Hz	3.00
✓ 01-04	Mid-point Voltage 1 of Motor 1	0.0V~480.0V	22.0
01-05	Mid-point Frequency 2 of Motor 1	0.00~599.00Hz	1.50
✓ 01-06	Mid-point Voltage 2 of Motor 1	0.0V~480.0V	10.0
01-07	Min. Output Frequency of Motor 1	0.00~599.00Hz	0.50
✓ 01-08	Min. Output Voltage of Motor 1	0.0V~480.0V	2.0
01-09	Start-Up Frequency	0.00~599.00Hz	0.50
✓ 01-10	Output Frequency Upper Limit	0.00~599.00Hz	599.00
✓ 01-11	Output Frequency Lower Limit	0.00~599.00Hz	0
✓ 01-12	Accel. Time 1	Pr.01-45=0: 0.00~600.00 second Pr.01-45=1: 0.00~6000.0 second	10.00 10.0
✓ 01-13	Decel Time 1	Pr.01-45=0: 0.00~600.00 second Pr.01-45=1: 0.00~6000.0 second	10.00 10.0
✓ 01-14	Accel Time 2	Pr.01-45=0: 0.00~600.00 second Pr.01-45=1: 0.00~6000.0 second	10.00 10.0
✓ 01-15	Decel Time 2	Pr.01-45=0: 0.00~600.00 second Pr.01-45=1: 0.00~6000.0 second	10.00 10.0
✓ 01-16	Accel Time 3	Pr.01-45=0: 0.00~600.00 second Pr.01-45=1: 0.00~6000.0 second	10.00 10.0
✓ 01-17	Decel Time 3	Pr.01-45=0: 0.00~600.00 second Pr.01-45=1: 0.00~6000.0 second	10.00 10.0
✓ 01-18	Accel Time 4	Pr.01-45=0: 0.00~600.00 second Pr.01-45=1: 0.00~6000.0 second	10.00 10.0
✓ 01-19	Decel Time 4	Pr.01-45=0: 0.00~600.00 second Pr.01-45=1: 0.00~6000.0 second	10.00 10.0
✓ 01-20	JOG Acceleration Time	Pr.01-45=0: 0.00~600.00 second Pr.01-45=1: 0.00~6000.0 second	10.00 10.0
✓ 01-21	JOG Deceleration Time	Pr.01-45=0: 0.00~600.00 second Pr.01-45=1: 0.00~6000.0 second	10.00 10.0
✓ 01-22	JOG Frequency	0.00~599.00Hz	6.00
✓ 01-23	1st/4th Accel/decel Frequency	0.00~599.00Hz	0.00
✓ 01-24	S-curve Acceleration Begin Time 1	Pr.01-45=0: 0.00~25.00 second Pr.01-45=1: 0.0~250.0 second	0.20 0.2
✓ 01-25	S-curve Acceleration Arrival Time 2	Pr.01-45=0: 0.00~25.00 second Pr.01-45=1: 0.0~250.0 second	0.20 0.2
✓ 01-26	S-curve Deceleration Begin Time 1	Pr.01-45=0: 0.00~25.00 second Pr.01-45=1: 0.0~250.0 second	0.20 0.2

Pr.	Explanation	Settings	Factory Setting
✓ 01-27	S-curve Deceleration Arrival Time 2	Pr.01-45=0: 0.00~25.00 second Pr.01-45=1: 0.0~250.0 second	0.20 0.2
01-28	Skip Frequency 1 (upper limit)	0.00~599.00Hz	0.00
01-29	Skip Frequency 1 (lower limit)	0.00~599.00Hz	0.00
01-30	Skip Frequency 2 (upper limit)	0.00~599.00Hz	0.00
01-31	Skip Frequency 2 (lower limit)	0.00~599.00Hz	0.00
01-32	Skip Frequency 3 (upper limit)	0.00~599.00Hz	0.00
01-33	Skip Frequency 3 (lower limit)	0.00~599.00Hz	0.00
01-34	Zero-speed Mode	0: Output waiting 1: Zero-speed operation 2: Fmin (Refer to Pr.01-07, 01-41)	0
01-35	Output Frequency of Motor 2	0.00~599.00Hz	60.00/ 50.00
01-36	Output Voltage of Motor 2	0.0V~510.0V	400.0
01-37	Mid-point Frequency 1 of Motor 2	0.00~599.00Hz	3.00
✓ 01-38	Mid-point Voltage 1 of Motor 2	0.0V~480.0V	22.0
01-39	Mid-point Frequency 2 of Motor 2	0.00~599.00Hz	1.50
✓ 01-40	Mid-point Voltage 2 of Motor 2	0.0V~480.0V	10.0
01-41	Min. Output Frequency of Motor 2	0.00~599.00Hz	0.50
✓ 01-42	Min. Output Voltage of Motor 2	0.0V~480.0V	2.0
01-43	V/f Curve Selection	0: V/f curve determined by Pr.01-00~01-08 1: 1.5 th V/F curve 2: 2 nd V/F curve 3: 60Hz (voltage saturation in 50Hz) 4: 72Hz (voltage saturation in 60Hz) 5: 3 rd decreasing (50Hz) 6: 2 nd decreasing (50Hz) 7: 3 rd decreasing (60Hz) 8: 2 nd decreasing (60Hz) 9: Mid. Starting torque (50Hz) 10: High starting torque (50Hz) 11: Mid. Starting torque (60Hz) 12: High starting torque (60Hz) 13: 90Hz (voltage saturation in 60Hz) 14: 120Hz (voltage saturation in 60Hz) 15: 180Hz (voltage saturation in 60Hz)	0
✓ 01-44	Optimal Acceleration/Deceleration Setting	0: Linear accel. /decel. 1: Auto accel.; linear decel. 2: Linear accel.; auto decel. 3: Auto accel./decel. 4: Linear, stall prevention by auto accel./decel. (limit by Pr.01-12~01-21)	0
01-45	Time Unit for Accel. /Decel. and S Curve	0: Unit: 0.01 sec 1: Unit: 0.1 sec	0
✓ 01-46	CANopen Quick Stop Time	Pr. 01-45=0: 0.00~600.00 sec Pr. 01-45=1: 0.0~6000.0 sec	1.00/ 1.0
01-47	Reserved		
01-48	Reserved		
01-49	Deceleration Method	0: Normal decel. 1: Over fluxing decel. 2: Traction energy control	0

02 Digital Input/Output Parameters

Pr.	Explanation	Settings	Factory Setting
02-00	2-wire/3-wire Operation Control	0: 2-wire mode 1, power on for operation control 1: 2-wire mode 2, power on for operation control 2: 3-wire, power on for operation control	0
02-01	Multi-function Input Command 1 (MI1)	0: No function	1
02-02	Multi-function Input Command 2 (MI2)	1: Multi-step speed command 1/multi-step position command 1	2
02-03	Multi-function Input Command 3 (MI3)	2: Multi-step speed command 2/multi-step position command 2	3
02-04	Multi-function Input Command 4 (MI4)	3: Multi-step speed command 3/multi-step position command 3	4
02-05	Multi-function Input Command 5 (MI5)	4: Multi-step speed command 4/multi-step position command 4	0
02-06	Multi-function Input Command 6 (MI6)	5: Reset	0
02-07	Multi-function Input Command 7 (MI7)	6: JOG command (By KPC-CC02 or external control)	0
02-08	Multi-function Input Command 8 (MI8)	7: Acceleration/deceleration speed inhibit	0
02-26	Input terminal of I/O extension card (MI10)	8: The 1 st , 2 nd acceleration/deceleration time selection	0
02-27	Input terminal of I/O extension card (MI11)	9: The 3 rd , 4 th acceleration/deceleration time selection	0
02-28	Input terminal of I/O extension card (MI12)	10: EF Input (Pr.07-20)	0
02-29	Input terminal of I/O extension card (MI13)	11: B.B input from external (Base Block)	0
02-30	Input terminal of I/O extension card (MI14)	12: Output stop	0
02-31	Input terminal of I/O extension card (MI15)	13: Cancel the setting of optimal accel. /decel. time 14: Switch between motor 1 and motor 2 15: Operation speed command from AVI1 16: Operation speed command from ACI 17: Operation speed command from AVI2 18: Emergency stop (Pr.07-20) 19: Digital up command 20: Digital down command 21: PID function disabled 22: Clear counter 23: Input the counter value (MI6) 24: FWD JOG command 25: REV JOG command 26: Reserved 27: Reserved 28: Emergency stop (EF1) 29: Signal confirmation for Y-connection 30: Signal confirmation for Δ-connection 31~37: Reserved 38: Disable EEPROM write function 39: Reserved 40: Force coast to stop 41: HAND switch 42: AUTO switch 43~48: Reserved 49: Drive enable 50: Slave dEb action to execute 51: Selection for PLC mode bit0	0

Pr.	Explanation	Settings	Factory Setting
		52: Selection for PLC mode bit1	
		53: Trigger CANopen quick stop	
		54: UVW Output Electromagnetic valve Switch	
		55: Brake release	
		56: Local/Remote Selection	
		57: Reserved	
		58: Enable fire mode (with RUN Command)	
		59: Enable fire mode (without RUN Command)	
		60: All motors disabled	
		61: Motor #1 disabled	
		62: Motor #2 disabled	
		63: Motor #3 disabled	
		64: Motor #4 disabled	
		65: Motor #5 disabled	
		66: Motor #6 disabled	
		67: Motor #7 disabled	
		68: Motor #8 disabled	
		69: Preheating Command	
✓	02-09 UP/DOWN key mode	0: up/down by the accel. /decel. time 1: up/down constant speed (Pr.02-10)	0
✓	02-10 Constant speed. The Accel. /Decel. Speed of the UP/DOWN Key	0.001~1.000Hz/ms	0.001
✓	02-11 Digital Input Response Time	0.000~30.000 second	0.005
✓	02-12 Digital Input Mode Selection	0000h~FFFFh (0: N.O.; 1: N.C.)	0000
✓	02-13 Multi-function Output 1 RY1	0: No function	11
✓	02-14 Multi-function Output 2 RY2	1: Operation Indication	1
✓	02-15 Multi-function Output 3 RY3	2: Operation speed attained	66
✓	02-36 Output terminal of the I/O extension card (MO10 or RA10)	3: Desired frequency attained 1 (Pr.02-22)	0
✓	02-37 Output Terminal of I/O Extension Card (MO11 or RA11)	4: Desired frequency attained 2 (Pr.02-24)	0
✓	02-38 Output Terminal of I/O Extension Card (MO12 or RA12)	5: Zero speed (Frequency command)	0
✓	02-39 Output Terminal of I/O Extension Card (MO13 or RA13)	6: Zero speed, include STOP(Frequency command)	0
✓	02-40 Output Terminal of I/O Extension Card (MO14 or RA14)	7: Over torque 1(Pr.06-06~06-08)	0
✓	02-41 Output Terminal of I/O Extension Card (MO15 or RA15)	8: Over torque 2(Pr.06-09~06-11)	0
✓	02-42 Output Terminal of I/O Extension Card (MO16)	9: Drive is ready	0
✓	02-43 Output Terminal of I/O Extension Card (MO17)	10: Low voltage warning (LV) (Pr.06-00)	0
✓	02-44 Output Terminal of I/O Extension Card (MO18)	11: Malfunction indication	0
✓	02-45 Output Terminal of I/O Extension Card (MO19)	12: Mechanical brake release(Pr.02-32)	0
✓	02-46 Output Terminal of I/O Extension Card (MO20)	13: Overheat warning (Pr.06-15, OH1, OH2)	0
✓		14: Software brake signal indication(Pr.07-00)	
		15: PID feedback error	
		16: Slip error (oSL)	
		17: Terminal count value attained, does not return to 0 (Pr.02-20)	

Pr.	Explanation	Settings	Factory Setting
		18: Preliminary count value attained, returns to 0 (Pr.02-19)	
		19: Base Block	
		20: Warning output	
		21: Over voltage warning	
		22: Over-current stall prevention warning	
		23: Over-voltage stall prevention warning	
		24: Operation mode indication	
		25: Forward command	
		26: Reverse command	
		27: Output when current >= Pr.02-33	
		28: Output when current < Pr.02-33	
		29: Output when frequency >= Pr.02-34	
		30: Output when frequency < Pr.02-34	
		31: Y-connection for the motor coil	
		32: Δ-connection for the motor coil	
		33: Zero speed (actual output frequency)	
		34: Zero speed include stop(actual output frequency)	
		35: Error output selection 1(Pr.06-23)	
		36: Error output selection 2(Pr.06-24)	
		37: Error output selection 3(Pr.06-25)	
		38: Error output selection 4(Pr.06-26)	
		39: Reserved	
		40: Speed attained (including Stop)	
		41: Reserved	
		42: Reserved	
		43: Reserved	
		44: Low current output (use with Pr.06-71~06-73)	
		45: UVW Output Electromagnetic valve Switch	
		46: Reserved	
		47: Closed brake output	
		48: Reserved	
		49: Reserved	
		50: Output for CANopen control	
		51: Output for RS485	
		52: Output for communication card	
		53: Fire mode indication	
		54: Bypass fire mode indication	
		55: Motor #1 Output	
		56: Motor #2 Output	
		57: Motor #3 Output	
		58: Motor #4 Output	
		59: Motor #5 Output	
		60: Motor #6 Output	
		61: Motor #7 Output	
		62: Motor #8 Output	
		63~65: Reserved	
		66: STO Logic A Output (Pr02-15)	
		67: Pressure Relief Indication	
		68: STO Logic B Output (Pr02-15)	
		69: Preheating Output Indication	
02-16 ~ 02-17	Reserved		
↗ 02-18	Multi-function output direction	0000h~FFFFh (0: N.O.; 1: N.C.)	0000
↗ 02-19	Terminal counting value attained (returns to 0)	0~65500	0
↗ 02-20	Preliminary counting value attained (not return to 0)	0~65500	0

Pr.	Explanation	Settings	Factory Setting	
✎ 02-21	Reserved			
✎ 02-22	Desired Frequency Attained 1	0.00~599.00Hz	60.00/ 50.00	
✎ 02-23	The Width of the Desired Frequency Attained 1	0.00~599.00Hz	2.00	
✎ 02-24	Desired Frequency Attained 2	0.00~599.00Hz	60.00/ 50.00	
✎ 02-25	The Width of the Desired Frequency Attained 2	0.00~599.00Hz	2.00	
	02-32	Brake Delay Time	0.000~65.000 sec.	0.000
✎ 02-33	Output Current Level Setting for Multi-function External Terminals	0.00~655.35%	0	
✎ 02-34	Output frequency setting for multi-function output terminal	0.00~599.00Hz (Motor speed when using PG Card)	0.00	
✎ 02-35	External Operation Control Selection after Reset and Activate	0: Disable 1: Drive runs if run command exists after reset	0	
✎ 02-47 ~ 02-49	Reserved			
	02-50	Status of Multi-function Input Terminal	Monitor the status of multi-function input terminals	Read only
	02-51	Status of Multi-function Output Terminal	Monitor the status of multi-function output terminals	Read only
	02-52	Display External Output terminal occupied by PLC	Monitor the status of PLC input terminals	Read only
	02-53	Display External Multi-function Output Terminal occupied by PLC	Monitor the status of PLC output terminals	Read only
	02-54	Display the Frequency Command Executed by External Terminal	0.01~599.00Hz (Read only)	Read only
	02-55	Reserved		
	02-56	Reserved		
	02-57	MO: Erase Current Level	0.00~655.35%	0.00
	02-58	Brake Detection Frequency	0.00~3.00Hz	0.00
	02-70	IO Expansion Card ID Parameter	0~7	Read only
	02-71	Reserved		
	02-72	Preheating Output Current Level	0~100%	0
	02-73	Preheating Output Cycle	0~100%	0

03 Analog Input/Output Parameters

	Pr.	Explanation	Settings	Factory Setting
✓	03-00	Analog Input Selection (AVI1)	0: No function	1
✓	03-01	Analog Input Selection (ACI)	1: Frequency command (speed limit under torque control mode)	0
✓	03-02	Analog Input Selection (AVI2)	2~3: Reserved	0
			4: PID target value	
			5: PID feedback signal	
			6: PTC thermistor input value	
			7~10: Reserved	
			11: PT100 thermistor input value	
			12: Reserved	
			13: PID Bias Value	
	14~17: Reserved			
✓	03-03	Analog Input Bias (AVI1)	-100.0~100.0%	0
✓	03-04	Analog Input Bias (ACI)	-100.0~100.0%	0
✓	03-05	Analog Input Bias (AVI2)	-100.0~100.0%	0
	03-06	Reserved		
✓	03-07	Positive/negative Bias Mode (AVI1)	0: No bias 1: Lower than or equal to bias 2: Greater than or equal to bias 3: The absolute value of the bias voltage while serving as the center 4: Serve bias as the center	0
✓	03-08	Positive/negative Bias Mode (ACI)		
✓	03-09	Positive/negative Bias Mode (AVI2)		
	03-10	Analog Frequency Command for Reverse Run	0: Negative frequency is not valid. Forward and reverse run is controlled by digital keypad or external terminal. 1: Negative frequency is valid. Positive frequency = forward run; negative frequency = reverse run. Direction can not be switched by digital keypad or external terminal control.	0
✓	03-11	Analog Input Gain (AVI1)	-500.0~500.0%	100.0
✓	03-12	Analog Input Gain (ACI)	-500.0~500.0%	100.0
✓	03-13	Analog Positive Input Gain 1 (AVI2)	-500.0~500.0%	100.0
✓	03-14	Analog Negative Input Gain 2 (AVI2)	-500.0~500.0%	100.0
✓	03-15	Analog Input Filter Time (AVI1)	0.00~20.00 sec.	0.01
✓	03-16	Analog Input Filter Time (ACI)	0.00~20.00 sec.	0.01
✓	03-17	Analog Input Filter Time (AVI2)	0.00~20.00 sec.	0.01
✓	03-18	Addition Function of the Analog Input	0: Disable (AVI1, ACI, AVI2) 1: Enable	0
✓	03-19	ACI Signal Loss	0: Disable 1: Continue operation at the last frequency 2: Decelerate to 0Hz 3: Stop immediately and display ACE	0

Pr.	Explanation	Settings	Factory Setting
✓ 03-20	Multi-function Output 1 (AFM1)	0: Output frequency (Hz)	0
✓ 03-23	Multi-function Output 2 (AFM2)	1: Frequency command (Hz)	0
		2: Motor speed (Hz)	
		3: Output current (rms)	
		4: Output voltage	
		5: DC Bus voltage	
		6: Power factor	
		7: Power	
		8: Reserved	
		9: AVI1	
		10: ACI	
		11: AVI2	
		12~19: Reserved	
		20: CANopen analog output	
		21: RS485 analog output	
	22: Communication card analog output		
	23: Constant voltage/current output		
✓ 03-21	Gain of Analog Output 1 (AFM1)	0~500.0%	100.0
✓ 03-22	Analog Output 1 when in REV Direction (AFM1)	0: Absolute output voltage 1: Reverse output 0V; Positive output 0-10V 2: Reverse output 5-0V; Positive output 5-10V	0
✓ 03-24	Gain of Analog Output 2 (AFM2)	0~500.0%	100.0
✓ 03-25	Analog Output 2 when in REV Direction (AFM2)	0: Absolute output voltage 1: Reverse output 0V; Positive output 0-10V 2: Reverse output 5-0V; Positive output 5-10V	0
✓ 03-26	Reserved		
✓ 03-27	AFM2 Output Bias	-100.00~100.00%	0.00
✓ 03-28	AVI1 Selection	0: 0-10V 1: 0-20mA 2: 4-20mA	0
✓ 03-29	ACI Selection	0: 4-20mA 1: 0-10V 2: 0-20mA	0
03-30	Status of PLC Output Terminal	Monitor the status of PLC output terminals	0000
✓ 03-31	AFM2 Output Selection	0: 0-20mA Output 1: 4-20mA Output	0
✓ 03-34	AFM1 Output Selection	0: 0-20mA Output 1: 4-20mA Output	0
✓ 03-32	AFM1 DC output setting level	0.00~100.00%	0.00
✓ 03-33	AFM2 DC Output Setting Level	0.00~100.00%	0.00
✓ 03-35	AFM1 filter output time	0.00 ~ 20.00 Seconds	0.01
✓ 03-36	AFM2 filter output time	0.00 ~ 20.00 Seconds	0.01
03-37 ~ 03-43	Reserved		
✓ 03-44	MO by source of AI level	0: AVI1 1: ACI 2: AVI2	0
✓ 03-45	AI upper level	-100.00%~100.00%	50.00%
✓ 03-46	AI lower level	-100.00%~100.00%	10.00%

Pr.	Explanation	Settings	Factory Setting
03-47 ~ 03-49	Reserved		
✎ 03-50	Analog Input Curve Selection	0: Regular Curve 1: 3 point curve of AVI1 2: 3 point curve of ACI 3: 3 point curve of AVI1 & ACI 4: 3 point curve of AVI2 5: 3 point curve of AVI1 & AVI2 6: 3 point curve of ACI & AVI2 7: 3 point curve of AVI1 & ACI & AVI2	7
✎ 03-51	AVI1 Low Point	Pr.03-28=0, 0.00~10.00V Pr.03-28≠0, 0.00~20.00mA	0.00
✎ 03-52	AVI1 Proportional Low Point	-100.00~100.00%	0.00
✎ 03-53	AVI1 Mid Point	Pr.03-28=0, 0.00~10.00V Pr.03-28≠0, 0.00~20.00mA	5.00
✎ 03-54	AVI1 Proportional Mid Point	-100.00~100.00%	50.00
✎ 03-55	AVI1 High Point	Pr.03-28=0, 0.00~10.00V Pr.03-28≠0, 0.00~20.00mA	10.00
✎ 03-56	AVI1 Proportional High Point	-100.00~100.00%	100.00
✎ 03-57	ACI Low Point	Pr.03-29=1, 0.00~10.00V Pr.03-29≠1, 0.00~20.00mA	4.00
✎ 03-58	ACI Proportional Low Point	-100.00~100.00%	0.00
✎ 03-59	ACI Mid Point	Pr.03-29=1, 0.00~10.00V Pr.03-29≠1, 0.00~20.00mA	12.00
✎ 03-60	ACI Proportional Mid Point	-100.00~100.00%	50.00
✎ 03-61	ACI High Point	Pr.03-29=1, 0.00~10.00V Pr.03-29≠1, 0.00~20.00mA	20.00
✎ 03-62	ACI Proportional High Point	-100.00~100.00%	100.00
✎ 03-63	Positive AVI2 Voltage Low Point	0.00~10.00V	0.00
✎ 03-64	Positive AVI2 Voltage Proportional Low Point	-100.00%~100.00%	0.00
✎ 03-65	Positive AVI2 Voltage Mid Point	0.00~10.00V	5.00
✎ 03-66	Positive AVI2 Voltage Proportional Mid Point	-100.00%~100.00%	50.00
✎ 03-67	Positive AVI2 Voltage High Point	0.00~10.00V	10.00
✎ 03-68	Positive AVI2 Voltage Proportional High Point	-100.00%~100.00%	100.00

04 Multi-step Speed Parameters

	Pr.	Explanation	Settings	Factory Setting
✓	04-00	1st Step Speed Frequency	0.00~599.00Hz	0.00
✓	04-01	2nd Step Speed Frequency	0.00~599.00Hz	0.00
✓	04-02	3rd Step Speed Frequency	0.00~599.00Hz	0.00
✓	04-03	4th Step Speed Frequency	0.00~599.00Hz	0.00
✓	04-04	5th Step Speed Frequency	0.00~599.00Hz	0.00
✓	04-05	6th Step Speed Frequency	0.00~599.00Hz	0.00
✓	04-06	7th Step Speed Frequency	0.00~599.00Hz	0.00
✓	04-07	8th Step Speed Frequency	0.00~599.00Hz	0.00
✓	04-08	9th Step Speed Frequency	0.00~599.00Hz	0.00
✓	04-09	10th Step Speed Frequency	0.00~599.00Hz	0.00
✓	04-10	11th Step Speed Frequency	0.00~599.00Hz	0.00
✓	04-11	12th Step Speed Frequency	0.00~599.00Hz	0.00
✓	04-12	13th Step Speed Frequency	0.00~599.00Hz	0.00
✓	04-13	14th Step Speed Frequency	0.00~599.00Hz	0.00
✓	04-14	15th Step Speed Frequency	0.00~599.00Hz	0.00
	04-15 ~ 04-49	Reserved		
✓	04-50	PLC buffer 0	0~65535	0
✓	04-51	PLC buffer 1	0~65535	0
✓	04-52	PLC buffer 2	0~65535	0
✓	04-53	PLC buffer 3	0~65535	0
✓	04-54	PLC buffer 4	0~65535	0
✓	04-55	PLC buffer 5	0~65535	0
✓	04-56	PLC buffer 6	0~65535	0
✓	04-57	PLC buffer 7	0~65535	0
✓	04-58	PLC buffer 8	0~65535	0
✓	04-59	PLC buffer 9	0~65535	0
✓	04-60	PLC buffer 10	0~65535	0
✓	04-61	PLC buffer 11	0~65535	0
✓	04-62	PLC buffer 12	0~65535	0
✓	04-63	PLC buffer 13	0~65535	0
✓	04-64	PLC buffer 14	0~65535	0
✓	04-65	PLC buffer 15	0~65535	0
✓	04-66	PLC buffer 16	0~65535	0
✓	04-67	PLC buffer 17	0~65535	0
✓	04-68	PLC buffer 18	0~65535	0
✓	04-69	PLC buffer 19	0~65535	0

05 Motor Parameters

Pr.	Explanation	Settings	Factory Setting
05-00	Motor Auto Tuning	0: No function 1: Rolling test for induction motor(IM) (Rs, Rr, Lm, Lx, no-load current) 2: Static test for induction motor(IM) 5: Dynamic test for PM(SPM) motor 13: Stacic test for PM(IPM) motor	0
05-01	Full-load Current of Induction Motor 1(A)	10~120% of drive's rated current	###
✓ 05-02	Rated Power of Induction Motor 1(kW)	0~655.35kW	###
✓ 05-03	Rated Speed of Induction Motor 1 (rpm)	0~65535 1710 (60Hz 4poles) ; 1410(50Hz 4 poles)	1710
05-04	Pole Number of Induction Motor 1	2~20	4
05-05	No-load Current of Induction Motor 1 (A)	0~ Pr.05-01 factory setting	###
05-06	Stator Resistance (Rs) of Induction Motor 1	0.000~65.535Ω	0.000
05-07	Rotor Resistance (Rr) of Induction Motor 1	0.000~65.535Ω	0.000
05-08	Magnetizing Inductance (Lm) of Induction Motor 1	0~6553.5mH	0.0
05-09	Stator Inductance (Lx) of Induction Motor 1	0~6553.5mH	0.0
05-10 ~ 05-12	Reserved		
05-13	Full-load Current of Induction Motor 2 (A)	10~120%	###
✓ 05-14	Rated Power of Induction Motor 2 (kW)	0~655.35kW	###
✓ 05-15	Rated Speed of Induction Motor 2 (rpm)	0~65535 1710(60Hz 4 poles) ; 1410(50Hz 4 poles)	1710
05-16	Pole Number of Induction Motor 2	2~20	4
05-17	No-load Current of Induction Motor 2 (A)	0~ Pr.05-01 factory setting	###
05-18	Stator Resistance (Rs) of Induction Motor 2	0.000~65.535Ω	0.000
05-19	Rotor Resistance (Rr) of Induction Motor 2	0.000~65.535Ω	0.000
05-20	Magnetizing Inductance (Lm) of Induction Motor 2	0~6553.5mH	0.0
05-21	Stator Inductance (Lx) of Induction Motor 2	0~6553.5mH	0.0
05-22	Induction Motor 1/ 2 Selection	1: motor 1 2: motor 2	1
✓ 05-23	Frequency for Y-connection/Δ -connection Switch of Induction Motor	0.00~599.00Hz	60.00
05-24	Y-connection/Δ -connection Switch of Induction Motor	0: Disable 1: Enable	0
05-25	Delay Time for Y-connection/Δ -connection Switch of Induction Motor	0.000~60.000 seconds	0.200
05-26	Reserved		

Pr.	Explanation	Settings	Factory Setting
05-27	Reserved		
05-28	Motor drive's Accumulated Operating Watt per Hour (W-Hour)	Read only	0.0
05-29	Motor drive's Accumulated Operating Kilowatt per Hour (KW-Hour)	Read only	0.0
05-30	Motor Drive's Accumulated Operating Megawatt per Hour (MW-Hour)	Read only	0.0
05-31	Accumulative Motor Operation Time (Min)	00~1439	0
05-32	Accumulative Motor Operation Time (day)	00~65535	0
05-33	Induction Motor and Permanent Magnet Motor Selection	0: Induction Motor 1: SPM Permanent Magnet Motor 2: IPM Permanent Magnet Motor	0
05-34	Full-load current of Permanent Magnet Motor	0.00~655.35Amps	0.00
✓ 05-35	Rated Power of Permanent Magnet Motor	0.00~655.35kW	0.00
✓ 05-36	Rated speed of Permanent Magnet Motor	0~65535rpm	2000
05-37	Pole number of Permanent Magnet Motor	0~65535	10
05-38	Inertia of Permanent Magnet Motor	0.0~6553.5 kg.cm ²	0.0
05-39	Stator Resistance of PM Motor	0.000~65.535Ω	0.000
05-40	Permanent Magnet Motor Ld	0.00~655.35mH	0.000
05-41	Permanent Magnet Motor Lq	0.00~655.35mH	0.000
✓ 05-42	PG Offset angle of PM Motor	0.0~360.0°	0.0
✓ 05-43	Ke parameter of PM Motor	0~65535 (Unit: V/1000rpm)	0

06 Protection Parameters

	Pr.	Explanation	Settings	Factory Setting
✓	06-00	Low Voltage Level	300.0~440.0Vdc	360.0
✓	06-01	Over-voltage Stall Prevention	700.0~900.0Vdc	760.0
✓	06-02	Selection for Over-voltage Stall Prevention	0: Traditional over-voltage stall prevention 1: Smart over-voltage prevention	0
✓	06-03	Over-current Stall Prevention during Acceleration	Normal Load: 0~160%(100%: drive's rated current) Light Load: 0~130%(100%: drive's rated current)	120
✓	06-04	Over-current Stall Prevention during Operation	Normal Load: 0~160%(100%: drive's rated current) Light Load: 0~130%(100%: drive's rated current)	120
✓	06-05	Accel. /Decel. Time Selection of Stall Prevention at Constant Speed	0: by current accel/decel time 1: by the 1st accel/decel time 2: by the 2nd accel/decel time 3: by the 3rd accel/decel time 4: by the 4th accel/decel time 5: by auto accel/decel	0
✓	06-06	Over-torque Detection Selection (OT1)	0: No function 1: Continue operation after Over-torque detection during constant speed operation 2: Stop after Over-torque detection during constant speed operation 3: Continue operation after Over-torque detection during RUN 4: Stop after Over-torque detection during RUN	0
✓	06-07	Over-torque Detection Level (OT1)	10~200% (100%: drive's rated current)	120
✓	06-08	Over-torque Detection Time (OT1)	0.1~60.0 sec.	0.1
✓	06-09	Over-torque Detection Selection (OT2)	0: No function 1: Continue operation after Over-torque detection during constant speed operation 2: Stop after Over-torque detection during constant speed operation 3: Continue operation after Over-torque detection during RUN 4: Stop after Over-torque detection during RUN	0
✓	06-10	Over-torque Detection Level (OT2)	10~200% (100%: drive's rated current)	120
✓	06-11	Over-torque Detection Time (OT2)	0.1~60.0 sec.	0.1
✓	06-12	Current Limit	0~200% (100%: drive's rated current)	150
✓	06-13	Electronic Thermal Relay Selection (Motor 1)	0: Inverter motor (with external forced cooling) 1: Standard motor (so motor with fan on the shaft) 2: Disable	2
✓	06-14	Electronic Thermal Characteristic for Motor 1	30.0~600.0 sec.	60.0
✓	06-15	Heat Sink Over-heat (OH1) Warning	0.0~110.0°C	105.0
✓	06-16	Stall Prevention Limit Level	0~100% (Pr.06-03, Pr.06-04)	50
	06-17	Fault Record 1 (Present Fault Record)	0: No fault record	0
	06-18	Fault Record 2	1: Over-current during acceleration (ocA)	0
	06-19	Fault Record 3	2: Over-current during deceleration (ocd)	0
	06-20	Fault Record 4	3: Over-current during constant speed(ocn)	0
	06-21	Fault Record 5	4: Ground fault (GFF)	0

Pr.	Explanation	Settings	Factory Setting
06-22	Fault Record 6	5: IGBT short-circuit (occ)	0
		6: Over-current at stop (ocS)	
		7: Over-voltage during acceleration (ovA)	
		8: Over-voltage during deceleration (ovd)	
		9: Over-voltage during constant speed (ovn)	
		10: Over-voltage at stop (ovS)	
		11: Low-voltage during acceleration (LvA)	
		12: Low-voltage during deceleration (Lvd)	
		13: Low-voltage during constant speed (Lvn)	
		14: Stop mid-low voltage (LvS)	
		15: Phase loss protection (OrP)	
		16: IGBT over-heat (oH1)	
		17: Inner temp. over-heat (oH2)	
		18: tH1o (TH1 open: IGBT over-heat protection error)	
		19: tH2o (TH2 open: Inner temp. over-heat protection error)	
		20: Reserved	
		21: Drive over-load (oL)	
		22: Electronics thermal relay 1 (EoL1)	
		23: Electronics thermal relay 2 (EoL2)	
		24: Motor overheat (oH3) (PTC/PT100)	
		25: Reserved	
		26: Over-torque 1 (ot1)	
		27: Over-torque 2 (ot2)	
		28: Low current (uC)	
		29: Reserved	
		30: Memory write-in error (cF1)	
		31: Memory read-out error (cF2)	
		32: Reserved	
		33: U-phase current detection error (cd1)	
		34: V-phase current detection error (cd2)	
		35: W-phase current detection error (cd3)	
		36: Clamp current detection error (Hd0)	
		37: Over-current detection error (Hd1)	
		38: Over-voltage detection error (Hd2)	
		39: Unusual IGBT short-circuiting (Hd3)	
		40: Auto tuning error (AUE)	
		41: PID feedback loss (AFE)	
		42~47: Reserved	
		48: Analog current input loss (ACE)	
		49: External fault input (EF)	
		50: Emergency stop (EF1)	
		51: External Base Block (bb)	
		52: Password error (PcodeE)	
		53: Reserved	
		54: Communication error (cE1)	
		55: Communication error (cE2)	
		56: Communication error (cE3)	
		57: Communication error (cE4)	
		58: Communication Time-out (cE10)	
		59: Reserved	
		60: Brake transistor error (bF)	
		61: Y-connection/ Δ -connection switch error (ydc)	
		62: Decel. Energy Backup Error (dEb)	
		63: Slip error (oSL)	
		64: Electromagnet switch error (ryF)	
		65~71: Reserved	
		72: Channel 1 (STO1~SCM1) internal hardware error (STL1)	
		73: External safety gate (S1)	

Pr.	Explanation	Settings	Factory Setting	
		74: FIRE mode output		
		75: Reserved		
		76: Safety Torque Off (STO)		
		77: Channel 2 (STO2~SCM2) internal hardware error (STL2)		
		78: Channel 1 and Channel 2 internal hardware error (STL3)		
		79: U phase over current (Uocc)		
		80: V phase over current (Vocc)		
		81: W phase over current (Wocc)		
		82: U phase output phase loss (OPHL)		
		83: V phase output phase loss (OPHL)		
		84: W phase output phase loss (OPHL)		
		85~89: Reserved		
		90: FStp Inner PLC function is forced to stop		
		91~98: Reserved		
		99: TRAP CPU command error		
		100: Reserved		
		101: CANopen software disconnect1 (CGdE)		
		102: CAN open software disconnect2 (CHbE)		
		103: CANopen synchronous error (CSyE)		
		104: CANopen hardware disconnect (CbFE)		
		105: CANopen index setting error (CIde)		
		106: CANopen slave station number setting error (CAde)		
		107: CANopen index setting exceed limit (CFrE)		
		108~110: Reserved		
		111: Internal communication overtime error (ictE)		
✓	06-23	Fault Output Option 1	0~65535(refer to bit table for fault code)	0
✓	06-24	Fault Output Option 2	0~65535(refer to bit table for fault code)	0
✓	06-25	Fault Output Option 3	0~65535(refer to bit table for fault code)	0
✓	06-26	Fault Output Option 4	0~65535(refer to bit table for fault code)	0
✓	06-27	Electronic Thermal Relay Selection 2 (Motor 2)	0: Inverter motor (with external forced cooling) 1: Standard motor (so motor with fan on the shaft) 2: Disable	2
✓	06-28	Electronic Thermal Characteristic for Motor 2	30.0~600.0 sec	60.0
✓	06-29	PTC Detection Selection	0: Warn and keep operation 1: Warn and ramp to stop 2: Warn and coast to stop 3: No warning	0
✓	06-30	PTC Level	0.0~100.0%	50.0
	06-31	Frequency Command for Malfunction	0.00~655.35Hz	Read only
	06-32	Output Frequency at Malfunction	0.00~655.35Hz	Read only
	06-33	Output Voltage at Malfunction	0.0~6553.5 V	Read only
	06-34	DC Voltage at Malfunction	0.0~6553.5 V	Read only
	06-35	Output Current at Malfunction	0.00~655.35 Amp	Read only
	06-36	IGBT Temperature at Malfunction	-3276.7~3276.7 °C	Read only
	06-37	Capacitance Temperature at Malfunction	-3276.7~3276.7 °C	Read only

Pr.	Explanation	Settings	Factory Setting
06-38	Motor Speed in rpm at Malfunction	-32767~32767 rpm	Read only
06-39	Reserved		
06-40	Status of Multi-function Input Terminal at Malfunction	0000h~FFFFh	Read only
06-41	Status of Multi-function Output Terminal at Malfunction	0000h~FFFFh	Read only
06-42	Drive Status at Malfunction	0000h~FFFFh	Read only
06-43	Reserved		
✓ 06-44	STO Latch Selection	0 : STO Latch 1 : STO No Latch	0
✓ 06-45	Treatment to Output Phase Loss Detection (OPHL)	0: Warn and keep operation 1: Warn and ramp to stop 2: Warn and coast to stop 3: No warning	3
✓ 06-46	Deceleration Time of Output Phase Loss	0~65.535 sec	0.500
✓ 06-47	Current detection level of output phase loss	0.00~100.00%	1.00
✓ 06-48	DC Brake Time of Output Phase Loss	0~65.535sec	0.000
✓ 06-49	LvX Auto Reset	0: Disable 1: Enable	0
✓ 06-50	Time for Input Phase Loss Detection	0.00~600.00 sec	0.20
06-51	Reserved		
✓ 06-52	Ripple of Input Phase Loss	0.0~320.0 Vdc	60.0
✓ 06-53	Treatment for the detected Input Phase Loss (OrP)	0: warn and ramp to stop 1: warn and coast to stop	0
06-54	Fault Code Record Index	0~6	Read only
06-55	Derating Protection	0: constant rated current and limit carrier wave by load current and temperature 1: constant carrier frequency and limit load current by setting carrier wave 2: constant rated current(same as setting 0), but close current limit	0
✓ 06-56	PT100 Detected Level 1	0.000~10.000V	5.000
✓ 06-57	PT100 Detected Level 2	0.000~10.000V	7.000
✓ 06-58	PT100 Level 1 Frequency Protect	0.00~599.00Hz	0.00
✓ 06-59	PT100 activation level delay time	0~6000 sec.	60
✓ 06-60	Software Detection GFF Current Level	0.0~6553.5 %	60.0
✓ 06-61	Software Detection GFF Filter Time	0.00~655.35 sec	0.10
06-62	Reserved		
06-63	Fault Record 1 (Day)	0~65535 days	Read only
06-64	Fault Record 1 (Min)	0~1439 min	Read only
06-65	Fault Record 2 (Day)	0~65535 days	Read only

Pr.	Explanation	Settings	Factory Setting
06-66	Fault Record 2 (Min)	0~1439 min	Read only
06-67	Fault Record 3 (Day)	0~65535 days	Read only
06-68	Fault Record 3 (Min)	0~1439 min	Read only
06-69	Fault Record 4 (Day)	0~65535 days	Read only
06-70	Fault Record 4 (Min)	0~1439 min	Read only
✓ 06-71	Low Current Setting Level	0.0 ~ 100.0 %	0.0
✓ 06-72	Low Current Detection Time	0.00 ~ 360.00 sec.	0.00
✓ 06-73	Treatment for low current	0 : No function 1 : Warn and coast to stop 2 : Warn and ramp to stop by 2nd deceleration time 3 : Warn and operation continue	0
06-74 ~ 06-75	Reserved		
✓ 06-76	dEb motion offset setting	0~200.0 Vdc	40.0Vdc
06-77 ~ 06-79	Reserved		
06-80	Fire mode	0: No function 1: Forward operation 2: Reverse Operation	0
06-81	Operating Frequency when running Fire Mode(Hz)	0.00 to 599.00Hz	60.00
06-82	Bypass Fire Mode enabled	0: Disable Bypass 1: Enable Bypass	0
06-83	Delayed Time when Bypass Fire Mode	0.0 to 6550.0 sec	0.0
06-84	Auto reset counter of Fire Mode	0~10	0
06-85	Length of time to reset auto-counter (seconds)	0.0 to 6000.0 sec	60.0
06-86	Fire mode motion	0: Open loop control & manual reset fire mode 1: Close loop control & manual reset fire mode 2: Open loop control & auto reset fire mode 3: Close loop control & auto reset fire mode	0
06-87	Fire mode PID set point	0~100.00% (according to Pr.01-00 Max. operation frequency)	0.0

07 Special Parameters

	Pr.	Explanation	Settings	Factory Setting
✓	07-00	Software Brake Level	700.0~900.0Vdc	740.0
✓	07-01	DC Brake Current Level	0~100%	0
✓	07-02	DC Brake Time at RUN	0.0~60.0 sec.	0.0
✓	07-03	DC Brake Time at Stop	0.0~60.0 sec.	0.0
✓	07-04	DC Brake frequency at Stop	0.00~599.00Hz	0.00
✓	07-05	Voltage Increasing Gain	1~200%	100
✓	07-06	Restart after Momentary Power Loss	0: Stop operation 1: Speed search for last frequency command 2: Speed search for minimum output frequency	0
✓	07-07	Maximum Power Loss Duration	0.0~20.0 sec.	2.0
✓	07-08	Base Block Time	0.1~5.0 sec.	0.5
✓	07-09	Current Limit for Speed Search	20~200%	100
✓	07-10	Treatment to Restart After Fault	0: Stop operation 1: Speed search starts with current speed 2: Speed search starts with minimum output frequency	0
✓	07-11	Number of Times of Auto Restart After Fault	0~10	0
✓	07-12	Speed Search during Start-up	0: Disable 1: Speed search for maximum output frequency 2: Speed search for start-up motor frequency 3: Speed search for minimum output frequency	0
✓	07-13	dEb Selection	0: Disable 1: dEb with auto accel./decel., the output frequency will not return after power reply. 2: dEb with auto accel./decel., the output frequency will return after power reply.	0
✓	07-14	Reserved		
✓	07-15	Dwell Time at Accel.	0.00 ~ 600.00sec	0.00
✓	07-16	Dwell Frequency at Accel.	0.00 ~ 599.00Hz	0.00
✓	07-17	Dwell Time at Decel.	0.00 ~ 600.00sec	0.00
✓	07-18	Dwell Frequency at Decel.	0.00 ~ 599.00Hz	0.00
✓	07-19	Fan Cooling Control	0: Fan always ON 1: 1 minute after the AC motor drive stops, fan will be OFF 2: When the AC motor drive runs, the fan is ON. When the AC motor drive stops, the fan is OFF 3: Fan turns ON when preliminary IGBT temperature (around 60°C) is attained. 4: Fan always OFF	0
✓	07-20	Emergency Stop (EF) & Force to Stop Selection	0: Coast stop 1: By deceleration Time 1 2: By deceleration Time 2 3: By deceleration Time 3 4: By deceleration Time 4 5: System Deceleration 6: Automatic Deceleration	0
✓	07-21	Auto Energy-saving Operation	0: Disable 1: Enable	0

	Pr.	Explanation	Settings	Factory Setting
↗	07-22	Energy-saving Gain	10~1000%	100
↗	07-23	Auto Voltage Regulation(AVR) Function	0: Enable AVR 1: Disable AVR 2: Disable AVR during deceleration	0
↗	07-24	Filter Time of Torque Compensation (V/F and SVC control mode)	0.001~10.000 sec	0.500
↗	07-25	Filter Time of Slip Compensation (V/F and SVC control mode)	0.001~10.000 sec	0.100
↗	07-26	Torque Compensation Gain (V/F and SVC control mode)	0~10 (Default: 1 in SVC mode)	0
↗	07-27	Slip Compensation Gain (V/F and SVC control mode)	0.00~10.00	0.00
↗	07-28	Reserved		
↗	07-29	Slip Deviation Level	0.0~100.0%	0
↗	07-30	Detection Time of Slip Deviation	0.0~10.0 sec	1.0
↗	07-31	Over Slip Treatment	0: Warn and keep operation 1: Warn and ramp to stop 2: Warn and coast to stop 3: No warning	0
↗	07-32	Motor Hunting Gain	0~10000	1000
↗	07-33	Auto restart interval of Fault	0.0~6000.0 sec	60.0

08 High-function PID Parameters

Pr.	Explanation	Settings	Factory Setting
✓ 08-00	Input Terminal for PID Feedback	0: No function 1: Negative PID feedback: on analogue input acc. To setting 5 of Pr. 03-00 to Pr.03-02. 2~3: Reserved 4: Positive PID feedback from external terminal AVI (Pr.03-00) 5~8: Reserved	0
✓ 08-01	Proportional Gain (P)	0.0~100.0%	1.0
✓ 08-02	Integral Time (I)	0.00~100.00sec	1.00
✓ 08-03	Derivative Control (D)	0.00~1.00sec	0.00
✓ 08-04	Upper Limit of Integral Control	0.0~100.0%	100.0
✓ 08-05	PID Output Frequency Limit	0.0~110.0%	100.0
✓ 08-06	PID feedback value by communication protocol	-200.00~200.00%	Read only
✓ 08-07	PID Delay Time	0.0~35.0 sec	0.0
✓ 08-08	Feedback Signal Detection Time	0.0~3600.0 sec	0.0
✓ 08-09	Feedback Signal Fault Treatment	0: Warn and keep operation 1: Warn and ramp to stop 2: Warn and coast to stop 3: Warn and operate at last frequency	0
✓ 08-10	Sleep Frequency	0.00 ~ 599.00Hz or 0~200.00%	0.00
✓ 08-11	Wake-up Frequency	0.00 ~ 599.00Hz or 0~200.00%	0.00
✓ 08-12	Sleep Time	0.0 ~ 6000.0sec	0.0
✓ 08-13	PID Deviation Level	1.0 ~ 50.0%	10.0
✓ 08-14	PID Deviation Time	0.1~300.0sec	5.0
✓ 08-15	Reserved		
✓ 08-16	PID Compensation Selection	0: Parameter setting 1: Analog input	0
✓ 08-17	PID Compensation	-100.0~+100.0%	0
08-18	Setting of Sleep Mode Function	0: Follow PID output command 1: Follow PID feedback signal	0
✓ 08-19	Wakeup Integral Limit	0.0~200.0%	50.0
08-20	PID Mode Selection	0: Serial connection 1: Parallel connection	0
08-21	Enable PID to Change Operation Direction	0: Operation direction can be changed 1: Operation direction can not be changed	0
✓ 08-22	Wakeup Delay Time	0.00~600.00 Seconds	0.00

09 Communication Parameters

	Pr.	Explanation	Settings	Factory Setting
✓	09-00	COM1 Communication Address	1~254	1
✓	09-01	COM1 Transmission Speed	4.8~115.2Kbps	9.6
✓	09-02	COM1 Transmission Fault Treatment	0: Warn and continue operation 1: Warn and ramp to stop 2: Warn and coast to stop 3: No warning and continue operation	3
✓	09-03	COM1 Time-out Detection	0.0~100.0 sec.	0.0
✓	09-04	COM1 Communication Protocol	1: 7N2 (ASCII) 2: 7E1 (ASCII) 3: 7O1 (ASCII) 4: 7E2 (ASCII) 5: 7O2 (ASCII) 6: 8N1 (ASCII) 7: 8N2 (ASCII) 8: 8E1 (ASCII) 9: 8O1 (ASCII) 10: 8E2 (ASCII) 11: 8O2 (ASCII) 12: 8N1 (RTU) 13: 8N2 (RTU) 14: 8E1 (RTU) 15: 8O1 (RTU) 16: 8E2 (RTU) 17: 8O2 (RTU)	1
	09-05 ~ 09-08	Reserved		
✓	09-09	Response Delay Time	0.0~200.0ms	2.0
	09-10	Main Frequency of the Communication	0.00~599.00Hz	60.00
✓	09-11	Block Transfer 1	0~FFFF	0000h
✓	09-12	Block Transfer 2	0~FFFF	0000h
✓	09-13	Block Transfer 3	0~FFFF	0000h
✓	09-14	Block Transfer 4	0~FFFF	0000h
✓	09-15	Block Transfer 5	0~FFFF	0000h
✓	09-16	Block Transfer 6	0~FFFF	0000h
✓	09-17	Block Transfer 7	0~FFFF	0000h
✓	09-18	Block Transfer 8	0~FFFF	0000h
✓	09-19	Block Transfer 9	0~FFFF	0000h
✓	09-20	Block Transfer 10	0~FFFF	0000h
✓	09-21	Block Transfer 11	0~FFFF	0000h
✓	09-22	Block Transfer 12	0~FFFF	0000h
✓	09-23	Block Transfer 13	0~FFFF	0000h
✓	09-24	Block Transfer 14	0~FFFF	0000h
✓	09-25	Block Transfer 15	0~FFFF	0000h
✓	09-26	Block Transfer 16	0~FFFF	0000h

Pr.	Explanation	Settings	Factory Setting
09-27 ~ 09-29	Reserved		
09-30	Communication Decoding Method	0: Decoding Method 1 (20xx) 1: Decoding Method 2 (60xx)	1
09-31	Internal Communication Protocol	0: Modbus 485 -1: Internal Communication Slave 1 -2: Internal Communication Slave 2 -3: Internal Communication Slave 3 -4: Internal Communication Slave 4 -5: Internal Communication Slave 5 -6: Internal Communication Slave 6 -7: Internal Communication Slave 7 -8: Internal Communication Slave 8 -9: Reserved -10: Internal Communication Master -11: Reserved -12: Internal PLC Control	0
09-32	Reserved		
09-33	PLC command force to 0	0~FFFF	0000h
09-34	Reserved		
09-35	PLC Address	0: Disable 1~254	2
09-36	CANopen Slave Address	1~127	0
09-37	CANopen Speed	0: 1M bps 1: 500K bps 2: 250K bps 3: 125K bps 4: 100K bps (Delta only) 5: 50K bps	0
09-38	Reserved		
09-39	CANopen Warning Record	bit 0: CANopen Guarding Time out bit 1: CANopen Heartbeat Time out bit 2: CANopen SYNC Time out bit 3: CANopen SDO Time out bit 4: CANopen SDO buffer overflow bit 5: Can Bus Off bit 6: Error protocol of CANopen bit 7: Reserved bit 8: The setting values of CANopen indexes are fail bit 9: The setting value of CANopen address is fail bit10: The checksum value of CANopen indexes is fail	Read only
09-40	CANopen Decoding Method	0: Delta defined decoding method 1: CANopen DS402 Standard	1
09-41	CANopen Communication Status	0: Node Reset State 1: Com Reset State 2: Boot up State 3: Pre Operation State 4: Operation State 5: Stop State	Read Only
09-42	CANopen Control Status	0: Not ready for use state 1: Inhibit start state 2: Ready to switch on state 3: Switched on state 4: Enable operation state 7: Quick Stop Active state 13: Err Reaction Activation state	Read Only

Pr.	Explanation	Settings	Factory Setting
		14: Error state	
09-43	Reserved		
09-44	Reserved		
09-45	CANopen Master Function	0: Disable 1: Enable	0
09-46	CANopen Master Address	0~127	100
09-47 ~ 09-49	Reserved		
09-50	BACnet Dnet	0~127	10
09-51	BACnet Baud Rate	9.66~76.8 kbps	38.4
09-52	BACnet Device ID L	0~65535	10
09-53	BACnet Device ID H	0~63	0
09-54	Reserved		
09-55	BACnet Max Address	0~127	127
09-56	BACnet Password	0~65535	0
09-57 ~ 09-59	Reserved		
09-60	Identifications for Communication Card	0: No communication card 1: DeviceNet Slave 2: Profibus-DP Slave 3: CANopen Slave/Master 4: Modbus-TCP Slave 5: Ethernet/IP Slave 6~8: Reserved	0
09-61	Firmware Version of Communication Card	Read only	##
09-62	Product Code	Read only	##
09-63	Error Code	Read only	##
09-64 ~ 09-69	Reserved		
↗ 09-70	Address of Communication Card (for DeviceNet and PROFIBUS)	DeviceNet: 0-63 Profibus-DP: 1-125	1
↗ 09-71	Setting of DeviceNet Speed (for DeviceNet and PROFIBUS)	Standard DeviceNet: 0: 125Kbps 1: 250Kbps 2: 500Kbps 3: 1Mbps (Delta Only) Nonstandard DeviceNet: (Delta Only) 0: 10Kbps 1: 20Kbps 2: 50Kbps 3: 100Kbps 4: 125Kbps 5: 250Kbps 6: 500Kbps 7: 800Kbps 8: 1Mbps	2
↗ 09-72	Other Setting of DeviceNet Speed (for DeviceNet and PROFIBUS)	0: Disable In this mode, baud rate can only be 123K bps, 250K bps, 500K bps in standard DeviceNet speed 1: Enable In this mode, the baud rate of DeviceNet can be same as CANopen (0-8).	0

Pr.	Explanation	Settings	Factory Setting
09-73	Reserved		
09-74	Reserved		
✓ 09-75	IP Configuration of the Communication Card (for MODBUS TCP)	0~65535	0
✓ 09-76	IP Address 1 of the Communication Card (for MODBUS TCP)	0~65535	0
✓ 09-77	IP Address 2 of the Communication Card (for MODBUS TCP)	0~65535	0
✓ 09-78	IP Address 3 of the Communication Card (for MODBUS TCP)	0~65535	0
✓ 09-79	IP Address 4 of the Communication Card (for MODBUS TCP)	0~65535	0
✓ 09-80	Address Mask 1 of the Communication Card (for MODBUS TCP)	0~65535	0
✓ 09-81	Address Mask 2 of the Communication Card (for MODBUS TCP)	0~65535	0
✓ 09-82	Address Mask 3 of the Communication Card (for MODBUS TCP)	0~65535	0
✓ 09-83	Address Mask 4 of the Communication Card (for MODBUS TCP)	0~65535	0
✓ 09-84	Gateway Address 1 of the Communication Card (for MODBUS TCP)	0~65535	0
✓ 09-85	Gateway Address 2 of the Communication Card (for MODBUS TCP)	0~65535	0
✓ 09-86	Gateway Address 3 of the Communication Card (for MODBUS TCP)	0~65535	0
✓ 09-87	Gateway Address 4 of the Communication Card (for MODBUS TCP)	0~65535	0
✓ 09-88	Password for Communication Card (Low word) (for MODBUS TCP)	0~99	0
✓ 09-89	Password for Communication Card (High word) (for MODBUS TCP)	0~99	0
✓ 09-90	Reset Communication Card (for MODBUS TCP)	0: No function 1: Reset, return to factory setting	0
✓ 09-91	Additional Setting for Communication Card (for MODBUS TCP)	Bit 0: Enable IP filter Bit 1: Enable to write internet parameters (1bit). This bit will change to disable when it finishes saving the internet parameter updates. Bit 2: Enable login password (1bit). When enter login password, this bit will be enabled. After updating the parameters of communication card, this bit will change to disable.	0

Pr.	Explanation	Settings	Factory Setting
09-92	Status of Communication Card (for MODBUS TCP)	Bit 0: password enable When the communication card is set with password, this bit is enabled. When the password is clear, this bit is disabled.	0

10 Speed Feedback Control Parameters

**NOTE**

IM: Induction Motor; PM: Permanent Magnet Motor

Pr.	Explanation	Settings	Factory Setting
10-00 ~ 10-30	Reserved		
✓ 10-31	I/F Mode, current command	0~150%I _{rated} (Rated current % of motor)	40
✓ 10-32	PM Sensorless Observer Bandwidth for High Speed Zone	0.00~599.00Hz	5.00
10-33	Reserved		
✓ 10-34	PM Sensorless Observer Low-pass Filter Gain	0.00~655.35	1.00
10-35 ~ 10-38	Reserved		
✓ 10-39	Frequency when switch from I/F Mode to PM sensorless mode.	0.00~599.00Hz	20.00
✓ 10-40	Frequency when switch from I/F sensorless observer mode to V/F mode.	0.00~599.00Hz	20.00
✓ 10-41	I/F mode, low pass-filter time	0.0~6.0sec	0.2
✓ 10-42	Initial Angle Detection Time	0.0~3.0	1.0
10-43 ~ 10-48	Reserved		
✓ 10-49	Zero voltage time while start up	0.000~60.000 sec	00.000
✓ 10-50	Reserved		
✓ 10-51	Injection Frequency	0~1200Hz	500
✓ 10-52	Injection Magnitude	0.0~200.0V	15.0/30.0
✓ 10-53	PM motor rotor initial angle position detection method	0: Disable 1: Internal 1/4 rated current attracting the rotor to zero degrees 2: High frequency injection 3: Pulse injection 4~5: Reserved	0

11 Advanced Parameters

Group 11 Advanced Parameters are reserved.

12 Pump Parameters

Pr.	Explanation	Settings	Factory Setting
12-00	Circulative Control	0: No operation 1: Fixed Time Circulation (by time) 2: Fixed quantity circulation (by PID) 3: Fixed quantity control 4: Fixed Time Circulation+ Fixed quantity circulation 5: Fixed Time Circulation+ Fixed quantity control	0
12-01	Number of motors to be connected	From only 1 and up to 8 motors	1
12-02	Operating time of each motor (minutes)	0 to 65500 min	0
12-03	Delay Time due to the Acceleration (or the Increment) at Motor Switching	0.0 to 3600.0 sec	1.0
12-04	Delay Time due to the Deceleration (or the Decrement) at Motor Switching (seconds)	0.0 to 3600.0 sec	1.0
↗ 12-05	Delay time while fixed quantity circulation at Motor Switching (seconds)	0.0 to 3600.0 sec	10.0
↗ 12-06	Frequency when switching motors at fixed quantity circulation (Hz)	0.00 to 599.00 Hz	60.00
12-07	Action to do when Fixed Quantity Circulation breaks down.	0: Turn off all output 1: Motors powered by mains electricity continues to operate.	0
↗ 12-08	Frequency when stopping auxiliary motor (Hz)	0.00 to 599.00 Hz	0.00

13 Application Parameters by Industry

Pr.	Explanation	Settings	Factory Setting
13-00	Application selection	0: Disabled 1: User Parameter 2: Compressor IM 3: Fan 4: Pump	0
13-01 ~ 13-99	Application Parameter 1~99	00.00~14.99	00.00

Chapter 12 Description of Parameter Settings

12-1 Description of parameter settings

00 Drive Parameters

✎ This parameter can be set during operation.

00-00 Identity Code of the AC Motor Drive

Factory Setting: ##

Settings Read Only

00-01 Display AC Motor Drive Rated Current

Factory Setting: ##

Settings Read Only

📖 Pr. 00-00 displays the identity code of the AC motor drive. Using the following table to check if Pr.00-01 setting is the rated current of the AC motor drive. Pr.00-01 corresponds to the identity code Pr.00-00.

📖 The factory setting is the rated current for normal duty. Please set Pr.00-16 to 1 to display the rated current for the heavy duty.

Frame	A							B	
kW	0.75	1.5	2.2	3.7	4.0	5.5	7.5	11	15
HP	1	2	3	5	5	7.5	10	15	20
Pr.00-00	5	7	9	11	93	13	15	17	19
Rated Current for Light Duty (A)	3	4.2	5.5	8.5	10.5	13	18	24	32
Rated Current for Normal Duty (A)	1.7	3.0	4.0	6.0	9.0	10.5	12	18	24

Frame	B		C		D0		D	
kW	18.5	22	30	37	45	55	75	90
HP	25	30	40	50	60	75	100	125
Pr.00-00	21	23	25	27	29	31	33	35
Rated Current for Light Duty (A)	38	45	60	73	91	110	150	180
Rated Current for Normal Duty (A)	32	38	45	60	73	91	110	150

00-02 Parameter Reset

Factory Setting: 0

Settings 0: No Function

1: Parameter write protect

5: Reset KWH display to 0

6: Reset PLC (including CANopen Master Index)

7: Reset CANopen Index (Slave)





8: Reserved

9: All parameters are reset to factory settings(base frequency is 50Hz)

10: All parameters are reset to factory settings (base frequency is 60Hz)

📖 When it is set to 1, all parameters are read only except Pr.00-02~00-08 and it can be used with password setting for password protection. It needs to set Pr.00-02 to 0 before changing other parameter settings.

📖 When it is set to 9 or 10: all parameters are reset to factory settings. If password is set in Pr.00-08, input the password set in Pr.00-07 to reset to factory settings.

-  When it is set to 5, KWH display value can be reset to 0 even when the drive is operating. Pr. 05-26, 05-27, 05-28, 05-29, 05-30 reset to 0.
-  When it is set to 6: clear internal PLC program (includes the related settings of PLC internal CANopen master)
-  When it is set to 7: reset the related settings of CANopen slave.
-  When it is set to 6、7、9、10, please re-power the motor drive after setting.

 **00-03** Start-up Display Selection

Factory setting: 0

- Settings
- 0: Display the frequency command (F)
 - 1: Display the actual output frequency (H)
 - 2: Display User define (U)
 - 3: Output current (A)

 This parameter determines the start-up display page after power is applied to the drive. User defined choice display according to the setting in Pr.00-04.

 **00-04** Content of Multi-function Display

Factory setting: 3

- Settings
- 0: Display output current (A) (Unit: Amps)
 - 1: Display counter value (c) (Unit: CNT)
 - 2: Display actual output frequency (H) (Unit: Hz)
 - 3: Display DC-BUS voltage (v) (Unit: Vdc)
 - 4: Display output voltage (E) (Unit: Vac)
 - 5: Display output power angle (n) (Unit: deg)
 - 6: Display output power in kW (P) (Unit: Kw)
 - 7: Display actual motor speed rpm (r = 00: positive speed; -00 negative speed) (Unit: rpm)
 - 8: Reserved
 - 9: Reserved
 - 10: Display PID feedback (b) (Unit: %)
 - 11: Display AVI in % (1.), 0~10V/4-20mA/0-20mA corresponds to 0~100% (Refer to Note 2) (Unit: %)
 - 12: Display ACI in % (2.), 4~20mA/0~10V/0-20mA corresponds to 0~100% (Refer to Note 2) (Unit: %)
 - 13: Display AUI in % (3.), -10V~10V corresponds to -100~100% (Refer to Note 2) (Unit: %)
 - 14: Display the temperature of IGBT (i.) (Unit: °C)
 - 15: Display the temperature of capacitance (c.) (Unit: °C)
 - 16: The status of digital input (ON/OFF) refer to Pr.02-12 (i) (Refer to Note3)
 - 17: Display digital output status ON/OFF (Pr.02-18) (o) (refer to NOTE 4)
 - 18: Display the multi-step speed that is executing (S)

- 19: The corresponding CPU pin status of digital input (d) (refer to NOTE 3)
- 20: The corresponding CPU pin status of digital output (O.) (refer to NOTE 4)
- 21~24: Reserved
- 25: Overload counting (0.00~100.00%) (h.) (Refer to Note 6) (Unit: %)
- 26: GFF Ground Fault (G.) (Unit: %)
- 27: DC Bus voltage ripple (r.) (Unit: %)
- 28: Display PLC register D1043 data (C) display in hexadecimal
- 29: Reserved
- 30 : Display output of user defined (U)
- 31 : H page x 00-05 Display user Gain(K)
- 32~33: Reserved
- 34: Operation speed of fan (F.) (Unit: %)
- 35: Reserved
- 36: Present operating carrier frequency of drive (Hz) (J.)
- 37: Reserved
- 38: Display drive status (6.) (Refer to Note 7)
- 39~40: Reserved
- 41: KWH display (J) (Unit: KWH)
- 42: PID reference (h) (Unit: %)
- 43: PID offset (o.) (Unit: %)
- 44: PID output frequency (b.) (Unit: Hz)
- 45: Hardware ID (0)

 **NOTE**

- When Pr.10-01 is set to 1000 and Pr.10-02 is set to 1/2, the display range for PG feedback will be from 0 to 4000.
When Pr.10-01 is set to 1000 and Pr.10-02 is set to 3/4/5, the display range for PG feedback will be from 0 to 1000.
Home position: If it has Z phase, Z phase will be regarded as home position. Otherwise, home position will be the encoder start up position.
- It can display negative values when setting analog input bias (Pr.03-03~03-10).
Example: assume that AVI input voltage is 0V, Pr.03-03 is 10.0% and Pr.03-07 is 4 (Serve bias as the center).
- Example: If REV, MI1 and MI6 are ON, the following table shows the status of the terminals.
0: OFF, 1: ON

Terminal	MI15	MI14	MI13	MI12	MI11	MI10	MI8	MI7	MI6	MI5	MI4	MI3	MI2	MI1	REV	FWD
Status	0	0	0	0	0	0	0	0	1	0	0	0	0	1	1	0

MI10~MI15 are the terminals for extension cards (Pr.02-26~02-31).

If REV, MI1 and MI6 are ON, the value is 0000 0000 1000 0110 in binary and 0086h in HEX. When Pr.00-04 is set to "16" or "19", it will display "0086h" with LED U is ON on the keypad KPC-CE01. The setting 16 is the status of digital input by Pr.02-12 setting and the setting 19 is the corresponding CPU pin status of digital input, the FWD/REV action and the three-wire MI are not controlled by Pr.02-12. User can set to 16 to monitor digital input status and then set to 19 to check if the wire is normal.

- Assume that RY1: Pr.02-13 is set to 9 (Drive ready). After applying the power to the AC motor drive, if there is no other abnormal status, the contact will be ON. The display status will be shown as follows.

N.O. switch status:

Terminal	MO20~MO17				MO16~MO13				MO12~MO10				Reserved	Reserved	RY3	RY2	RY1
Status	0	0	0	0	0	0	0	0	0	0	0	0	0	0	0	0	1

At the meanwhile, if Pr.00-04 is set to 17 or 20, it will display in hexadecimal "0001h" with LED U is ON on the keypad. The setting 17 is the status of digital output by Pr.02-18 setting and the setting 20 is the corresponding CPU pin status of digital output. User can set 17 to monitor the digital output status and then set to 20 to check if the wire is normal.

5. Setting 8: 100% means the motor rated torque. Motor rated torque = (motor rated power $\times 60 / 2\pi$) / motor rated speed
6. If Pr.00-04 = 25, when display value reaches 100.00%, the drive will show "oL" as an overload warning.
7. If Pr.00-04 = 38,
 - Bit 0: The drive is running forward.
 - Bit 1: The drive is running backward.
 - Bit 2: The drive is ready.
 - Bit 3: Errors occurred on the drive.
 - Bit 4: The drive is running.
 - Bit 5: Warnings on the drive.

00-05 Coefficient Gain in Actual Output Frequency Factory Setting: 1.00

Settings 0.00~160.00

 This parameter is to set coefficient gain in actual output frequency. Set Pr.00-04= 31 to display the calculation result on the screen (calculation = output frequency * Pr.00-05).



00-06 Software Version Factory Setting: #.#

Settings Read only

00-07 Parameter Protection Password Input Factory Setting: 0

Settings 1~9998, 10000~65535

Display 0~4 (the times of password attempts)

-  This parameter allows user to enter their password (which is set in Pr.00-08) to unlock the parameter protection and to make changes to the parameter.
-  Pr.00-07 and Pr.00-08 are used to prevent the personal miss-operation.
-  When the user have forgotten the password, clear the setting by input 9999 and press ENTER key, then input 9999 again and press Enter within 10 seconds. After decoding, all the settings will return to factory setting.

00-08 Parameter Protection Password Setting Factory Setting: 0

Settings 1~9998, 10000~65535

0: No password protection / password is entered correctly (Pr00-07)

1: Password has been set

 To set a password to protect your parameter settings. In the first time, password can be set

directly. After setting, the value of 00-08 will become 1, which means password protection is activated. When the password is set, if any parameter setting needs to be changed, be sure to enter correct password in 00-07, and then the password will be inactivated temporarily with 00-08 changing to 0. At this time, parameters setting can be changed. After setting, re-power the motor drive, and password will be activated again.

- 📖 To cancel the password protection, after entering correct password in 00-07, 00-08 also needs to be set as 0 again to inactive password protection permanently. If not, password protection will be active after motor drive re-power.
- 📖 The keypad copy function will work normally only when the password protection is inactivated temporarily or permanently, and password set in 00-08 will not be copied to keypad. So when copying parameters from keypad to motor drive, the password need to be set manually again in the motor drive to active password protection.

Password Decode Flow Chart

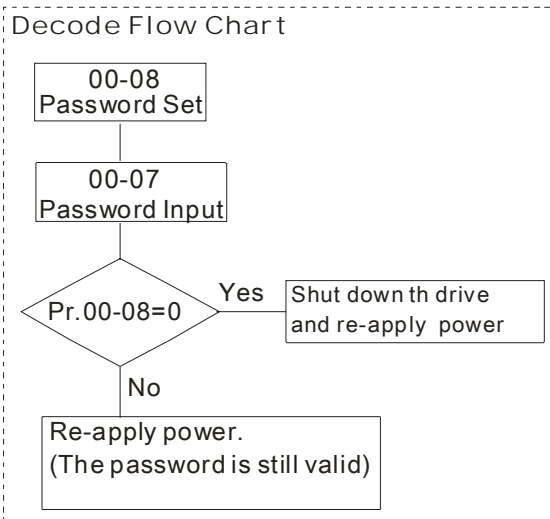
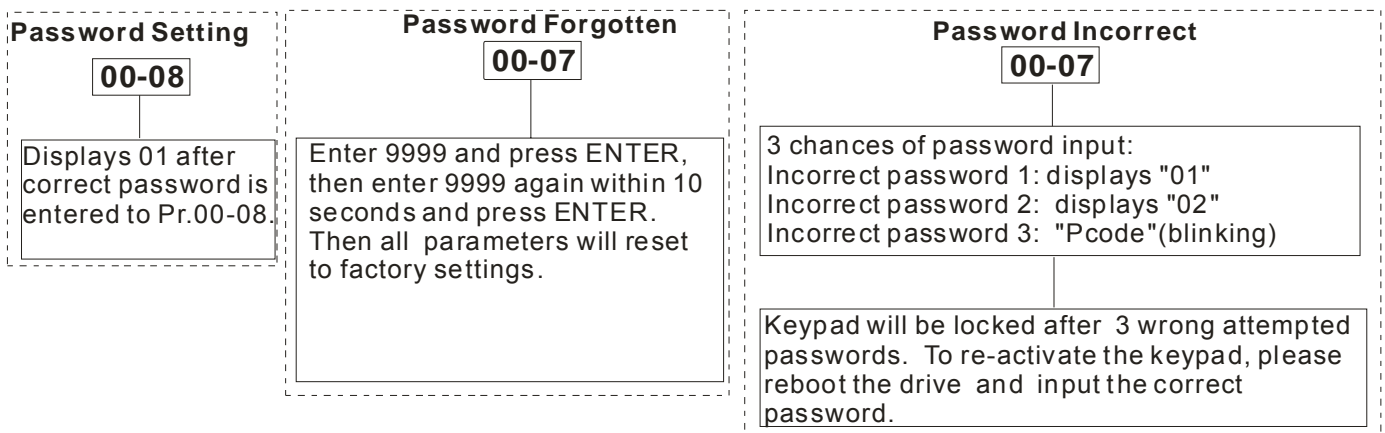

00-09	Reserved
00-10	Reserved

00-11	Control of Speed Mode
--------------	-----------------------

Factory Setting: 0

- Settings 0: VF (IM V/f control)
 2: SVC(IM/PM sensorless vector control)

- 📖 This parameter determines the control method of the AC motor drive:
 0: (IM V/f control): user can design proportion of V/f as required and can control multiple

motors simultaneously.

2: (IM/PM Sensorless vector control): get the optimal control by the auto-tuning of motor parameters.

When 00-10=0, and set Pr.00-11 to 0, the V/F control diagram is shown as follows.

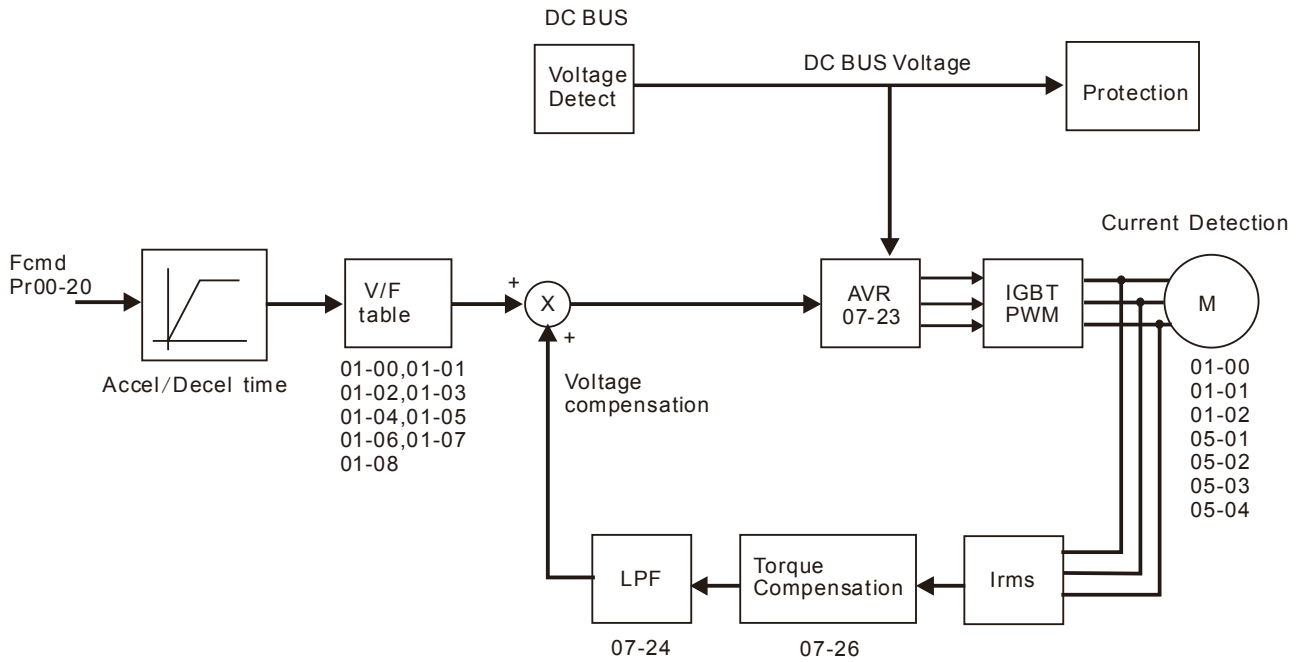

When 00-10=0, and set Pr.00-11 to 2, the sensorless vector control diagram is shown as follows.

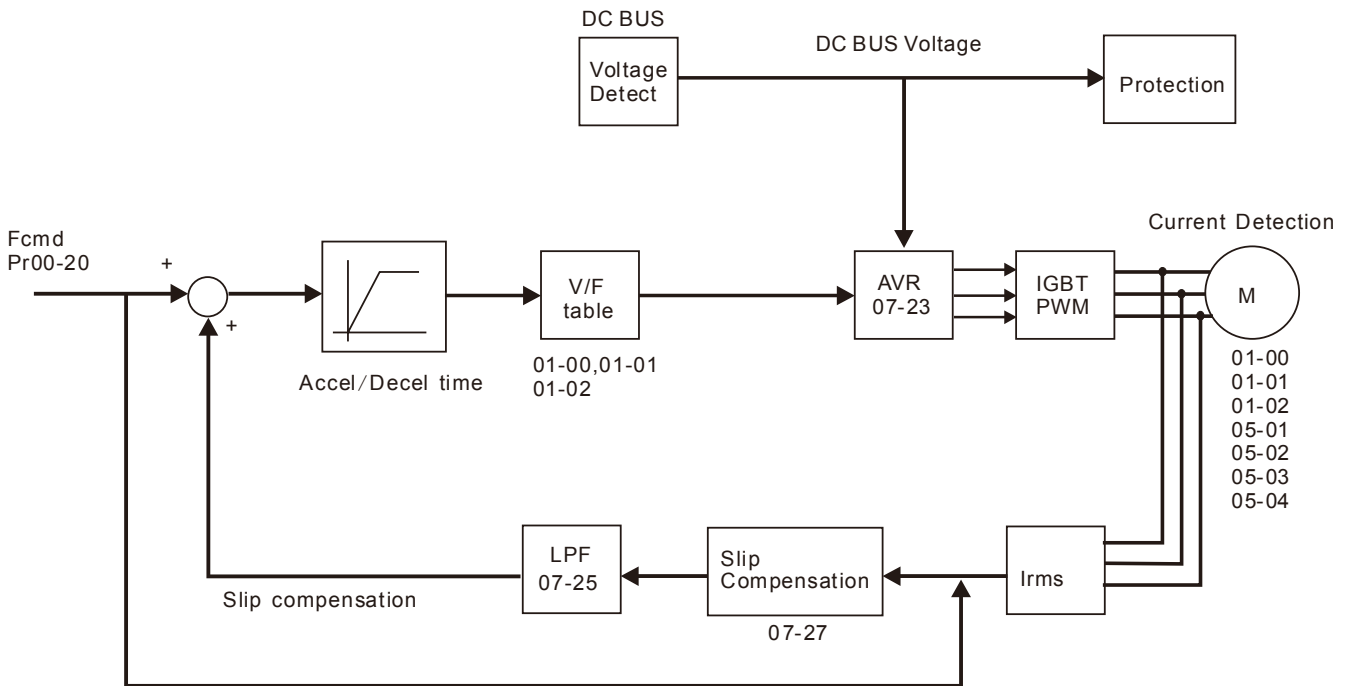

00-12	Reserved
00-15	Reserved
00-16	Load Selection

Factory Setting: 0

- Settings 0: Light load
- 1: Normal load

Light duty: over load ability is 120% rated output current in 60 second. Please refer to Pr.00-17 for

the setting of carrier. Refer to chapter 9 (specifications) or Pr.00-01 for the rated current.

- 📖 Normal duty: over load ability is 120% rated output current in 60 second (over load ability is 160% rated output current in 3 second). Please refer to Pr.00-17 for the setting of carrier wave. Refer to chapter 9 (specifications) or Pr.00-01 for the rated current.
- 📖 Pr.00-01 changes as the setting of Pr.00-16 changes. The default setting and maximum setting range of Pr.06-03, 06-04 will change as the setting of Pr.00-16 changes.



00-17 Carrier Frequency

Factory setting: Table below

Settings 2~15kHz

- 📖 This parameter determines the PWM carrier frequency of the AC motor drive.

Models	1-25HP [0.75-18.5kW]	30-100HP [22-75kW]	125HP [90kW]
Setting Range	02~15kHz	02~10kHz	02~09kHz
Normal Duty Factory Setting	6kHz	6kHz	6kHz
Light Duty Factory Setting	6kHz	6kHz	6kHz

Carrier Frequency	Acoustic Noise	Electromagnetic Noise or Leakage Current	Heat Dissipation	Current Wave
1kHz	Significant	Minimal	Minimal	
8kHz	↕	↕	↕	
15kHz	Minimal	Significant	Significant	

- 📖 From the table, we see that the PWM carrier frequency has a significant influence on the electromagnetic noise, AC motor drive heat dissipation, and motor acoustic noise. Therefore, if the surrounding noise is greater than the motor noise, lower the carrier frequency is good to reduce the temperature rise. Although it is quiet operation in the higher carrier frequency, the entire wiring and interference resistance should be considerate.

- 📖 When the carrier frequency is higher than the factory setting, it needs to protect by decreasing the carrier frequency. See Pr.06-55 for the related setting and details.

00-18 Reserved

00-19 PLC Command Mask (SOOC, SOOF, SOTC)

Factory Setting: Read Only

- Settings
- Bit 0: Control command by PLC force control
 - Bit 1: Frequency command by PLC force control
 - Bit 2: Reserved
 - Bit 3: Reserved

- 📖 This parameter determines if frequency command or control command is occupied by PLC

00-20 Source of the Master Frequency Command (AUTO)

Factory Setting: 0

- Settings
- 0: Digital keypad
 - 1: RS-485 serial communication
 - 2: External analog input (Pr.03-00)

- 3: External UP/DOWN terminal
- 6: CANopen communication card
- 8: Communication card (no CANopen card)

- It is used to set the source of the master frequency in AUTO mode.
- Pr.00-20 and 00-21 are for the settings of frequency source and operation source in AUTO mode. Pr.00-30 and 00-31 are for the settings of frequency source and operation source in HAND mode. The AUTO/HAND mode can be switched by the keypad KPC-CC02 or multi-function input terminal (MI).
- The factory setting of frequency source or operation source is for AUTO mode. It will return to AUTO mode whenever power on again after power off. If there is multi-function input terminal used to switch AUTO/HAND mode. The highest priority is the multi-function input terminal. When the external terminal is OFF, the drive won't receive any operation signal and can't execute JOG.

00-21 Source of the Operation Command (AUTO)

Factory Setting: 0

- Settings
- 0: Digital keypad
 - 1: External terminals. Keypad STOP disabled.
 - 2: RS-485 serial communication. Keypad STOP disabled.
 - 3: CANopen card
 - 5: Communication card (not includes CANopen card)

- It is used to set the source of the operation frequency in AUTO mode.
- When the operation command is controlled by the keypad KPC-CC02, keys RUN, STOP and JOG (F1) are valid.

00-22 Stop Method

Factory Setting: 0

- Settings
- 0: Ramp to stop
 - 1: Coast to stop

- The parameter determines how the motor is stopped when the AC motor drive receives a valid stop command.

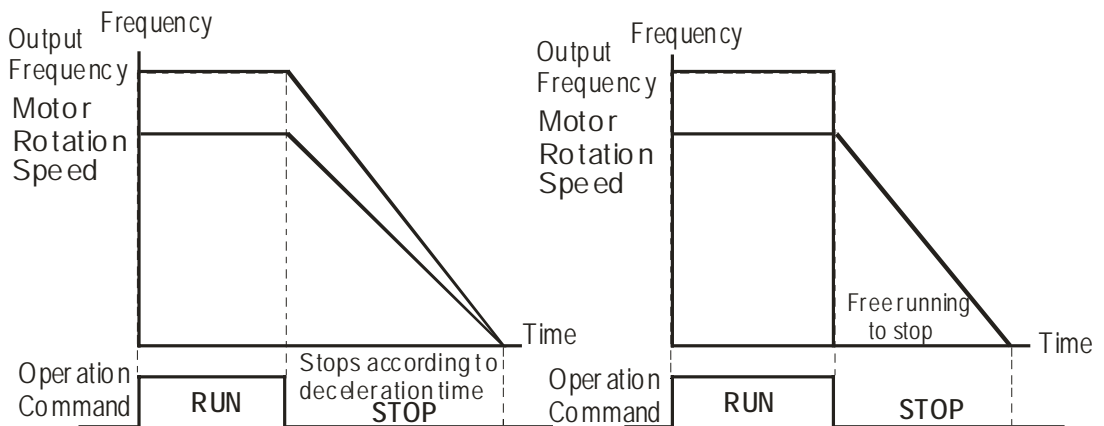

Ramp to Stop and Coast to Stop

- Ramp to stop:** the AC motor drive decelerates from the setting of deceleration time to 0 or

minimum output frequency (Pr. 01-09) and then stop (by Pr.01-07).

 **Coast to stop:** the AC motor drive stops the output instantly upon a STOP command and the motor free runs until it comes to a complete standstill.

(1) It is recommended to use “ramp to stop” for safety of personnel or to prevent material from being wasted in applications where the motor has to stop after the drive is stopped. The deceleration time has to be set accordingly.

(2) If the motor free running is allowed or the load inertia is large, it is recommended to select “coast to stop”. For example, blowers, punching machines and pumps

00-23 Control of Motor Direction

Factory Setting: 0

Settings 0: Enable forward/ reverse
1: Disable reverse
2: Disable forward

 This parameter enables the AC motor drives to run in the forward/reverse Direction. It may be used to prevent a motor from running in a direction that would consequently injure the user or damage the equipment.

00-24 Memory of Digital Operator (Keypad) Frequency Command

Factory Setting: Read Only

Settings Read only



 If keypad is the source of frequency command, when Lv or Fault occurs the present frequency command will be saved in this parameter.

00-25 User Defined Characteristics

Factory Setting: 0

Settings Bit 0~3: user defined decimal place
0000b: no decimal place
0001b: one decimal place
0010b: two decimal place
0011b: three decimal place
Bit 4~15: user defined unit
000xh: Hz
001xh: rpm
002xh: %
003xh: kg
004xh: m/s
005xh: kW
006xh: HP
007xh: ppm
008xh: 1/m
009xh: kg/s
00Axh: kg/m
00Bxh: kg/h
00Cxh: lb/s
00Dxh: lb/m
00Exh: lb/h
00Fhx: ft/s

- 010xh: ft/m
- 011xh: m
- 012xh: ft
- 013xh: degC
- 014xh: degF
- 015xh: mbar
- 016xh: bar
- 017xh: Pa
- 018xh: kPa 019xh: mWG
- 01Axh: inWG
- 01Bxh: ftWG
- 01Cxh: psi
- 01Dxh: atm
- 01Exh: L/s
- 01Fhx: L/m
- 020xh: L/h
- 021xh: m³/s
- 022xh: m³/h
- 023xh: GPM
- 024xh: CFM

-  Bit 0~3: Control F page, unit of user defined value (Pr00-04=d10, PID feedback) and the decimal point of Pr00-26 which supports up to 3 decimal points.
-  Bit 4~15: Control F page, unit of user defined value (Pr00-04=d10, PID feedback) and the display units of Pr00-26.

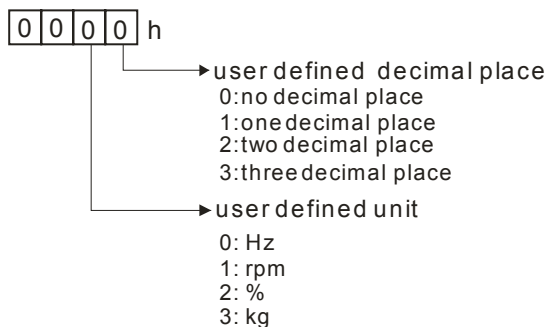

00-26 Max. User Defined Value

Factory Setting: 0

- Settings 0: Disable
- 1~65535 (when Pr.00-25 set to no decimal place)
 - 0.1~6553.5 (when Pr.00-25 set to 1 decimal place)
 - 0.01~655.35 (when Pr.00-25 set to 2 decimal place)
 - 0.001~65.535 (when Pr.00-25 set to 3 decimal place)

-  When Pr.00-26 is NOT set to 0. The user defined value is enabled. The value of this parameter should correspond to the frequency setting at Pr.01-00.

Example:

When the frequency at Pr. 01-00=60.00Hz, the max. user defined value at Pr. 00-26 is 100.0%. That also means Pr.00-25 is set at 0021h to select % as the unit.

 **NOTE**

The drive will display as Pr.00-25 setting when Pr.00-25 is properly set and Pr.00-26 is not 0.

00-27 User Defined Value

Factory Setting: Read only

Settings Read only

 Pr.00-27 will show user defined value when Pr.00-26 is not set to 0.

00-28 Switching from Auto mode to Hand mode

Factory Setting: 0

Settings

- bit0: Sleep Function Control Bit
 - 0: Sleep Function Control Bit
 - 1: Sleep function and Auto mode are the same
- bit1: Unit of the Control Bit
 - 0: Displaying Unit in Hz
 - 1: Same unit as the Auto mode
- bit2: PID Control Bit
 - 0: Cancel PID control
 - 1: PID control and Auto mode are the same.
- bit3: Frequency Source Control Bit
 - 0: Frequency command set by parameter, if the multi-step speed is activated, then multi-step speed has the priority.
 - 1: Frequency command set by Pr00-30, regardless if the multi-speed is activated.

00-29 LOCAL/REMOTE Selection

Factory Setting: 0

Settings

- 0: Standard HOA function
- 1: Switching Local/Remote, the drive stops
- 2: Switching Local/Remote, the drive runs as the REMOTE setting for frequency and operation status
- 3: Switching Local/Remote, the drive runs as the LOCAL setting for frequency and operation status
- 4: Switching Local/Remote, the drive runs as LOCAL setting when switch to Local and runs as REMOTE setting when switch to Remote for frequency and operation status.

 The factory setting of Pr.00-29 is 0 (standard Hand-Off-Auto function). The AUTO frequency and source of operation can be set by Pr.00-20 and Pr.00-21, and the HAND frequency and source of operation can be set by Pr.00-30 and Pr.00-31. AUTO/HAND mode can be selected or switched by using digital keypad (KPC-CC02) or setting multi-function input terminal MI= 41, 42.

 When external terminal MI is set to 41 and 42 (AUTO/HAND mode), the settings Pr.00-29=1,2,3,4 will be disabled. The external terminal has the highest priority among all command, Pr.00-29 will always function as Pr.00-29=0, standard HOA mode.

 When Pr.00-29 is not set to 0, Local/Remote function is enabled, the top right corner of digital keypad (KPC-CC02) will display "LOC" or "REM". The LOCAL frequency and source of operation can be set by Pr.00-20 and Pr.00-21, and the REMOTE frequency and source of operation can be set by Pr.00-30 and Pr.00-31. Local/Remote function can be selected or switched by using digital keypad (KPC-CC02) or setting external terminal MI=56. The AUTO key of the digital keypad now controls for the REMOTE function and HAND key now controls for the LOCAL function.

 When MI is set to 56 for LOC/REM selection, if Pr.00-29 is set to 0, then the external terminal is

disabled.

- When MI is set to 56 for LOC/REM selection, if Pr.00-29 is not set to 0, the external terminal has the highest priority of command and the ATUO/HAND keys will be disabled.

00-30 Source of the Master Frequency Command (HAND)

Factory Setting: 0

- Settings
- 0: Digital keypad
 - 1: RS-485 serial communication
 - 2: External analog input (Pr.03-00)
 - 3: External UP/DOWN terminal
 - 6: CANopen communication card
 - 8: Communication card (no CANopen card)

- It is used to set the source of the master frequency in HAND mode.

00-31 Source of the Operation Command (HAND)

Factory Setting: 0

- Settings
- 0: Digital keypad
 - 1: External terminals. Keypad STOP disabled.
 - 2: RS-485 serial communication. Keypad STOP disabled.
 - 3: CANopen communication card
 - 5: Communication card (not include CANopen card)

- It is used to set the source of the operation frequency in HAND mode.
- Pr.00-20 and 00-21 are for the settings of frequency source and operation source in AUTO mode. Pr.00-30 and 00-31 are for the settings of frequency source and operation source in HAND mode. The AUTO/HAND mode can be switched by the keypad KPC-CC02 or multi-function input terminal (MI).
- The factory setting of frequency source or operation source is for AUTO mode. It will return to AUTO mode whenever power on again after power off. If there is multi-function input terminal used to switch AUTO/HAND mode. The highest priority is the multi-function input terminal. When the external terminal is OFF, the drive won't receive any operation signal and can't execute JOG.

00-32 Digital Keypad STOP Function

Factory Setting: 0

- Settings
- 0: STOP key disable
 - 1: STOP key enable

- This parameter works when the source of operation command is not digital keypad (Pr00-21≠0). When Pr00-21=0, the stop key will not follow the setting of this parameter.

00-33
~ Reserved
00-47

↗ **00-48** Display Filter Time (Current)

Factory Settings: 0.100

Settings: 0.001~65.535 sec

📖 Set this parameter to minimize the current fluctuation displayed by digital keypad.

↗ **00-49** Display Filter Time (Keypad)

Factory Settings: 0.100

Settings: 0.001~65.535 sec

📖 Set this parameter to minimize the display value fluctuation displayed by digital keypad.

00-50 Software Version (date)

Factory Settings: #####

Settings: Read only

📖 This parameter displays the drive's software version by date.

00-51

~

Reserved

00-60

01 Basic Parameters

↗ This parameter can be set during operation.

01-00 Maximum Output Frequency

Factory Setting: 60.00/50.00

Settings 50.00~599.00Hz

Setting Range for /including 90kW(125HP) and above: 0.00~400.00Hz

📖 This parameter determines the AC motor drive's Maximum Output Frequency. All the AC motor drive frequency command sources (analog inputs 0 to +10V, 4 to 20mA, 0 to 20mA) are scaled to correspond to the output frequency range.

Setting Range for /including 90kW(125HP) and above: 0.00~400.00Hz

Minimum Carrier Wave Requirement	Maximum Output Frequency IM VF/ IM SVC
2k	200 Hz
3k	300 Hz
4k	400 Hz
5k	500 Hz
6k	599 Hz

01-01 Output Frequency of Motor 1 (base frequency and motor rated frequency)

01-35 Output Frequency of Motor 2 (base frequency and motor rated frequency)

Factory Setting: 60.00/50.00

Settings 0.00~599.00Hz

📖 This value should be set according to the rated frequency of the motor as indicated on the motor nameplate. If the motor is 60Hz, the setting should be 60Hz. If the motor is 50Hz, it should be set to 50Hz.

01-02 Output Voltage of Motor 1 (base frequency and motor rated frequency)

01-36 Output Voltage of Motor 2 (base frequency and motor rated frequency)

Factory Setting: 400.0

Settings series: 0.0~510.0V

📖 This value should be set according to the rated voltage of the motor as indicated on the motor nameplate. If the motor is 220V, the setting should be 220.0. If the motor is 200V, it should be set to 200.0.

📖 There are many motor types in the market and the power system for each country is also difference. The economic and convenience method to solve this problem is to install the AC motor drive. There is no problem to use with the different voltage and frequency and also can amplify the original characteristic and life of the motor.

01-03 Mid-point Frequency 1 of Motor 1

Factory Setting: 3.00

Settings 0.00~599.00Hz

↗ **01-04** Mid-point Voltage 1 of Motor 1

Factory Setting: 22.0

	Settings 0.0~480.0V	
	01-37 Mid-point Frequency 1 of Motor 2	Factory Setting: 3.00
	Settings 0.00~599.00Hz	
↗	01-38 Mid-point Voltage 1 of Motor 2	Factory Setting: 22.0
	Settings 0.0~480.0V	
	01-05 Mid-point Frequency 2 of Motor 1	Factory Setting: 1.50
	Settings 0.00~599.00Hz	
↗	01-06 Mid-point Voltage 2 of Motor 1	Factory Setting: 10.0
	Settings 460V series: 0.0~480.0V	
	01-39 Mid-point Frequency 2 of Motor 2	Factory Setting: 1.50
	Settings 0.00~599.00Hz	
↗	01-40 Mid-point Voltage 2 of Motor 2	Factory Setting: 10.0
	Settings 460V series: 0.0~480.0V	
	01-07 Min. Output Frequency of Motor 1	Factory Setting: 0.50
	Settings 0.00~599.00Hz	
↗	01-08 Min. Output Voltage of Motor 1	Factory Setting: 2.0
	Settings 0.0~480.0V	
	01-41 Min. Output Frequency of Motor 2	Factory Setting: 0.50
	Settings 0.00~599.00Hz	
↗	01-42 Min. Output Voltage of Motor 2	Factory Setting: 0.0

- 📖 V/f curve setting is usually set by the motor's allowable loading characteristics. Pay special attention to the motor's heat dissipation, dynamic balance, and bearing lubricity, if the loading characteristics exceed the loading limit of the motor.
- 📖 There is no limit for the voltage setting, but a high voltage at low frequency may cause motor damage, overheat, and stall prevention or over-current protection. Therefore, please use the low voltage at the low frequency to prevent motor damage.
- 📖 Pr.01-35 to Pr.01-42 is the V/f curve for the motor 2. When multi-function input terminals Pr.02-01~02-08 and Pr.02-26 ~Pr.02-31 are set to 14 and enabled, the AC motor drive will act as the 2nd V/f curve.
- 📖 The V/f curve for the motor 1 is shown as follows. The V/f curve for the motor 2 can be deduced

from it.

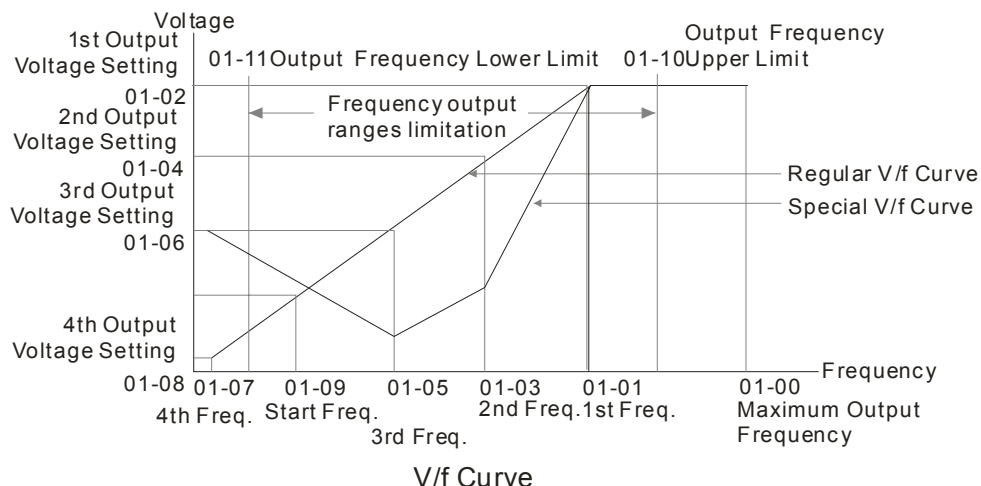

Common settings of V/f curve:

(1) General purpose

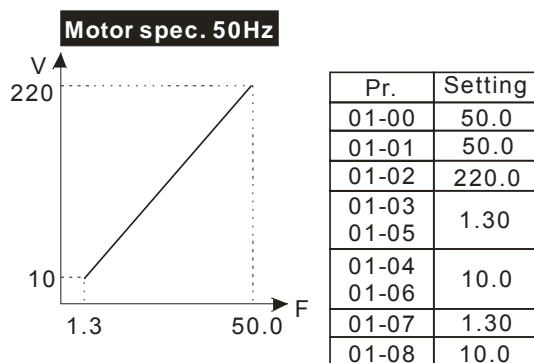
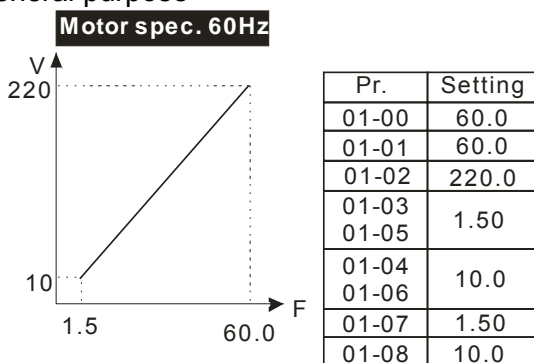

(2) Fan and hydraulic machinery

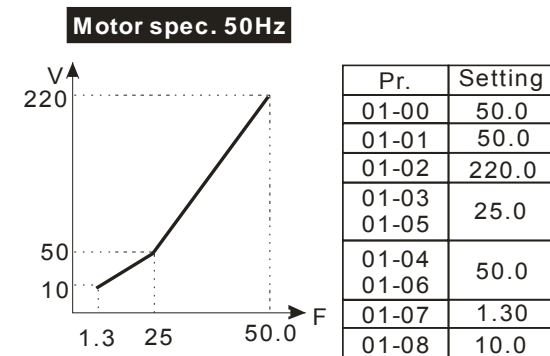
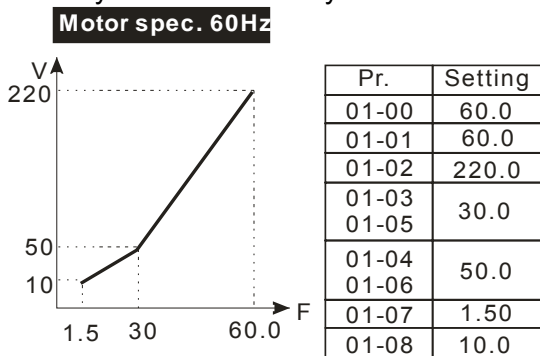

(3) High starting torque

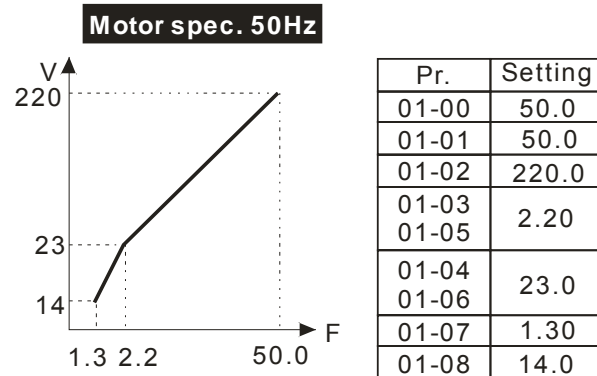
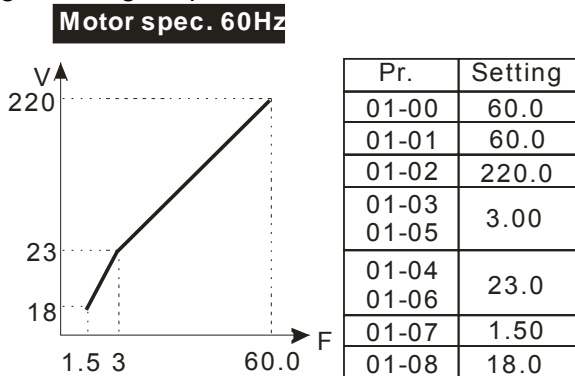

01-09 Start-Up Frequency

Factory Setting: 0.50

Settings 0.0~599.00Hz

- 📖 When start frequency is higher than the min. output frequency, drives' output will be from start frequency to the setting frequency. Please refer to the following diagram for details.
- 📖 Fcmd=frequency command,
 Fstart=start frequency (Pr.01-09),
 fstart=actual start frequency of drive,
 Fmin=4th output frequency setting (Pr.01-07/Pr.01-41),
 Flow=output frequency lower limit (Pr.01-11)
- 📖 Fcmd>Fmin and Fcmd<Fstart:
 - 📖 If Flow<Fcmd , drive will run with Fcmd directly.
 - 📖 If Flow>=Fcmd, drive will run with Fcmd firstly, then, accelerate to Flow according to acceleration time.
- 📖 The drive's output will stop immediately when output frequency has reach to Fmin during deceleration.

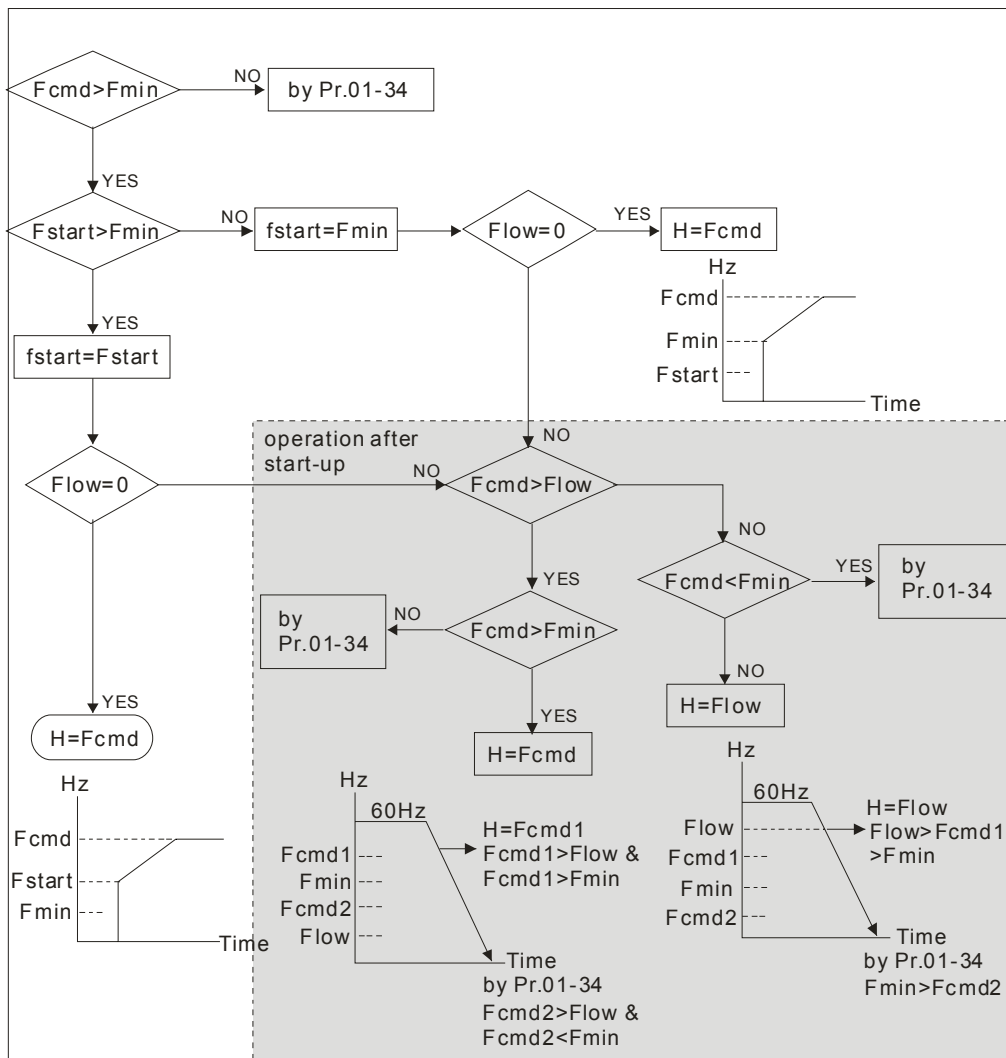

🚩 **01-10** Output Frequency Upper Limit

Factory Setting: 599.00

Settings 0.0~599.00Hz

01-11 Output Frequency Lower Limit

Factory Setting: 0.00

Settings 0.0~599.00Hz

- 📖 The upper/lower output frequency setting is used to limit the actual output frequency. If the frequency setting is higher than the upper limit (01-10), it will run with the upper limit frequency. If output frequency lower than output frequency lower limit (01-11) and frequency setting is higher than min. frequency (01-07), it will run with lower limit frequency. The upper limit frequency should be set to be higher than the lower limit frequency. Pr.01-10 setting must be \geq Pr.01-11 setting.
- 📖 Upper output frequency will limit the max. Output frequency of drive. If frequency setting is higher than Pr.01-10, the output frequency will be limited by Pr.01-10 setting.
- 📖 When the drive starts the function of slip compensation (Pr.07-27) or PID feedback control, drive output frequency may exceed frequency command but still be limited by this setting.
- 📖 Related parameters: Pr.01-00 Max. Operation Frequency and Pr.01-11 Output Frequency Lower Limit

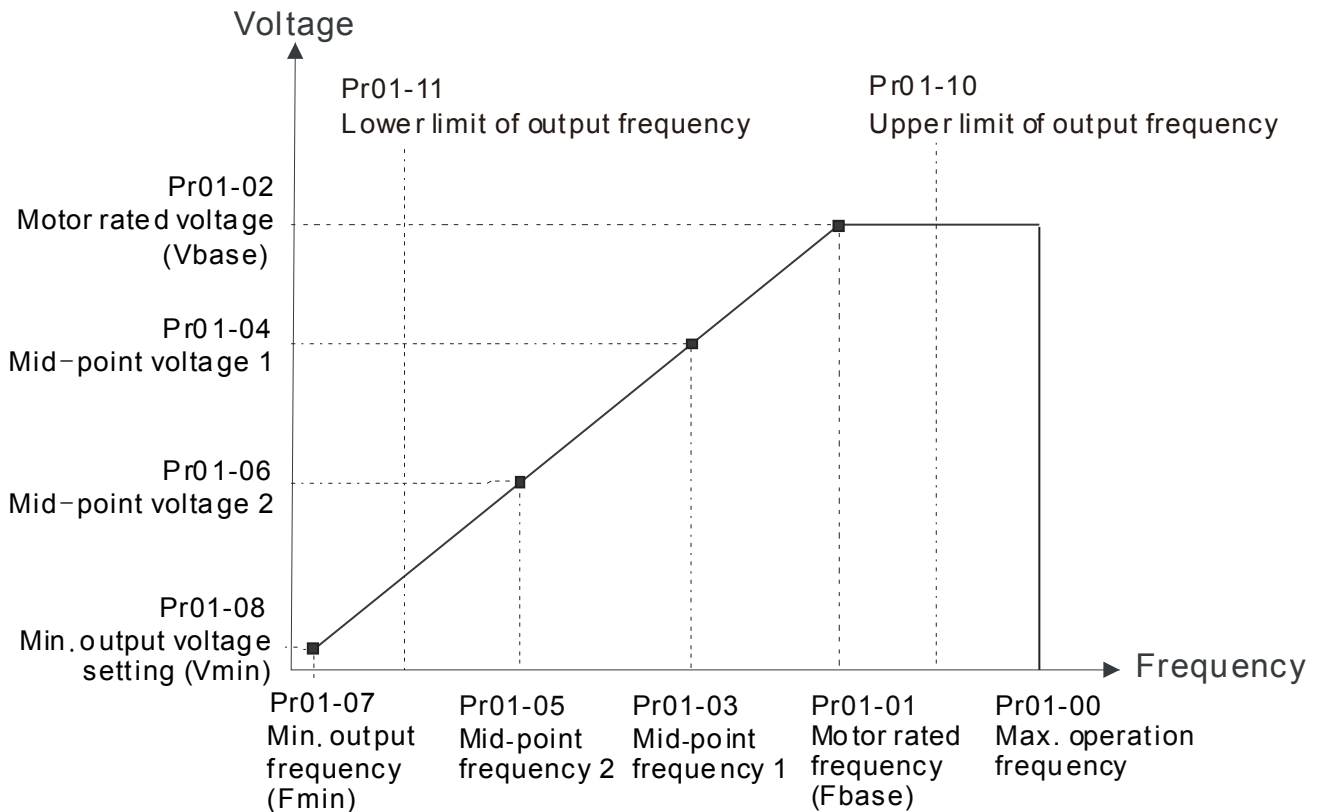

- 📖 Lower output frequency will limit the min. output frequency of drive. When drive frequency command or feedback control frequency is lower than this setting, drive output frequency will limit by the lower limit of frequency.
- 📖 When the drive starts, it will operate from min. output frequency (Pr.01-07) and accelerate to the setting frequency. It won't limit by lower output frequency setting.
- 📖 The setting of output frequency upper/lower limit is used to prevent personal misoperation, overheat due to too low operation frequency or damage due to too high speed.
- 📖 If the output frequency upper limit setting is 50Hz and frequency setting is 60Hz, max. output frequency will be 50Hz.
- 📖 If the output frequency lower limit setting is 10Hz and min. operation frequency setting (Pr.01-07)

is 1.5Hz, it will operate by 10Hz when the frequency command is greater than Pr.01-07 and less than 10Hz. If the frequency command is less than Pr.01-07, the drive will be in ready status and no output.

- 📖 If the frequency output upper limit is 60Hz and frequency setting is also 60Hz, only frequency command will be limit in 60Hz. Actual frequency output may exceed 60Hz after slip compensation.

↗	01-12	Accel. Time 1
↗	01-13	Decel. Time 1
↗	01-14	Accel. Time 2
↗	01-15	Decel. Time 2
↗	01-16	Accel. Time 3
↗	01-17	Decel. Time 3
↗	01-18	Accel. Time 4
↗	01-19	Decel. Time 4
↗	01-20	JOG Acceleration Time
↗	01-21	JOG Deceleration Time

Factory Setting: 10.00/10.0

Settings Pr.01-45=0: 0.00~600.00 seconds

Pr.01-45=1: 0.00~6000.00 seconds

- 📖 The Acceleration Time is used to determine the time required for the AC motor drive to ramp from 0Hz to Maximum Output Frequency (Pr.01-00).
- 📖 The Deceleration Time is used to determine the time require for the AC motor drive to decelerate from the Maximum Output Frequency (Pr.01-00) down to 0Hz.
- 📖 The Acceleration/Deceleration Time is invalid when using Pr.01-44 Optimal Acceleration/Deceleration Setting.
- 📖 The Acceleration/Deceleration Time 1, 2, 3, 4 are selected according to the Multi-function Input Terminals settings. The factory settings are Accel./Decel. time 1.
- 📖 When enabling torque limits and stalls prevention function, actual accel./decel. time will be longer than the above action time.
- 📖 Please note that it may trigger the protection function (Pr.06-03 Over-current Stall Prevention during Acceleration or Pr.06-01 Over-voltage Stall Prevention) when setting of accel./decel. time is too short.
- 📖 Please note that it may cause motor damage or drive protection enabled due to over current during acceleration when the setting of acceleration time is too short.
- 📖 Please note that it may cause motor damage or drive protection enabled due to over current during deceleration or over-voltage when the setting of deceleration time is too short.
- 📖 It can use suitable brake resistor (see Chapter 06 Accessories) to decelerate in a short time and prevent over-voltage.
- 📖 When enabling Pr.01-24~Pr.01-27, the actual accel./decel. time will be longer than the setting.

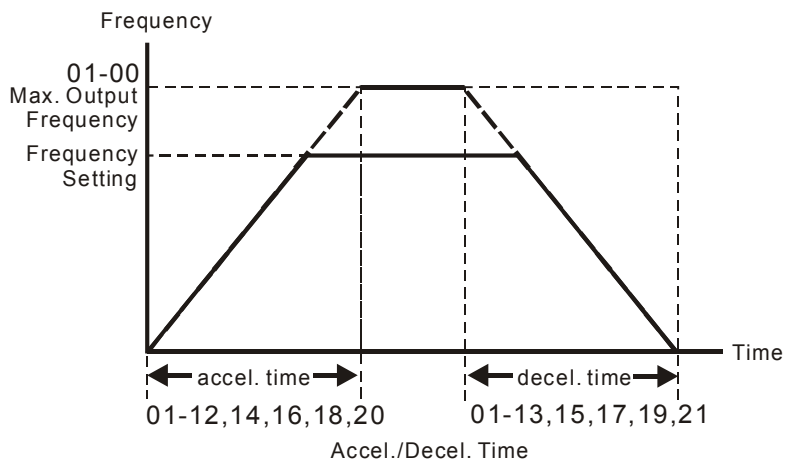

➤ **01-22** JOG Frequency Factory Setting: 6.00

Settings 0.00~599.00Hz

- 📖 Both external terminal JOG and key “F1” on the keypad KPC-CC01 can be used. When the jog command is ON, the AC motor drive will accelerate from 0Hz to jog frequency (Pr.01-22). When the jog command is OFF, the AC motor drive will decelerate from Jog Frequency to zero. The Jog Accel./Decel. time (Pr.01-20, Pr.01-21) is the time that accelerates from 0.0Hz to Pr.01-22 JOG Frequency.
- 📖 The JOG command can't be executed when the AC motor drive is running. In the same way, when the JOG command is executing, other operation commands are invalid.
- 📖 It does not support JOG function in the optional keypad KPC-CC02.

➤ **01-23** 1st/4th Accel./decel. Frequency Factory Setting: 0.00

Settings 0.00~599.00Hz

- 📖 The transition from acceleration/deceleration time 1 to acceleration/deceleration time 4, may also be enabled by the external terminals. The external terminal has priority over Pr. 01-23.
- 📖 When using this function, please set S-curve acceleration time as 0 if 4th acceleration time is set too short.

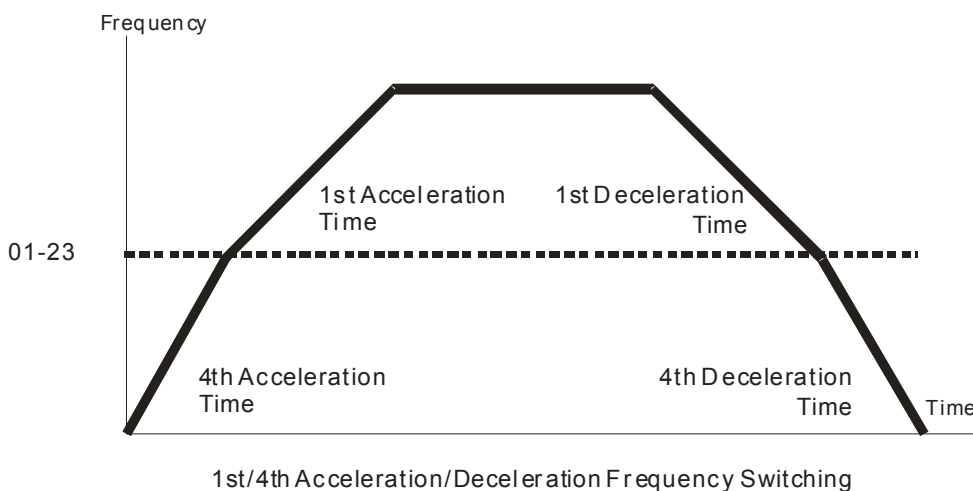

↗	01-24	S-curve Acceleration Begin Time 1
↗	01-25	S-curve Acceleration Arrival Time 2
↗	01-26	S-curve Deceleration Begin Time 1
↗	01-27	S-curve Deceleration Arrival Time 2

Factory Setting: 0.20/0.2

Settings Pr.01-45=0: 0.00~25.00 seconds

Pr.01-45=1: 0.00~250.0 seconds

It is used to give the smoothest transition between speed changes. The accel./decel. curve can adjust the S-curve of the accel./decel. When it is enabled, the drive will have different accel./decel. curve by the accel./decel. time.

The S-curve function is disabled when accel./decel. time is set to 0.

When Pr.01-12, 01-14, 01-16, 01-18 ≥ Pr.01-24 and Pr.01-25,

The Actual Accel. Time = Pr.01-12, 01-14, 01-16, 01-18 + (Pr.01-24 + Pr.01-25)/2

When Pr.01-13, 01-15, 01-17, 01-19 ≥ Pr.01-26 and Pr.01-27,

The Actual Decel. Time = Pr.01-13, 01-15, 01-17, 01-19 + (Pr.01-26 + Pr.01-27)/2

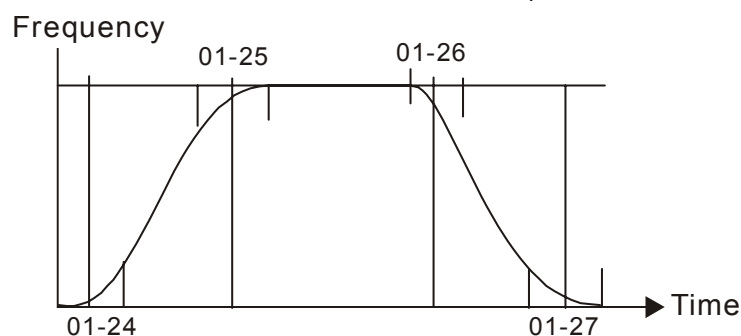

01-28	Skip Frequency 1 (upper limit)
01-29	Skip Frequency 1 (lower limit)
01-30	Skip Frequency 2 (upper limit)
01-31	Skip Frequency 2 (lower limit)
01-32	Skip Frequency 3 (upper limit)
01-33	Skip Frequency 3 (lower limit)

Factory Setting: 0.00

Settings 0.00~599.00Hz

These parameters are used to set the skip frequency of the AC drive. But the frequency output is continuous. There is no limit for the setting of these six parameters and can be used as required.

The skip frequencies are useful when a motor has vibration at a specific frequency bandwidth. By skipping this frequency, the vibration will be avoided. It offers 3 zones for use.

These parameters are used to set the skip frequency of the AC drive. But the frequency output is continuous. The limit of these six parameters is 01-28 ≥ 01-29 ≥ 01-30 ≥ 01-31 ≥ 01-32 ≥ 01-33. This function will be invalid when setting to 0.0.

The setting of frequency command (F) can be set within the range of skip frequencies. In this moment, the output frequency (H) will be limited by these settings.

When accelerating/decelerating, the output frequency will still pass the range of skip frequencies.

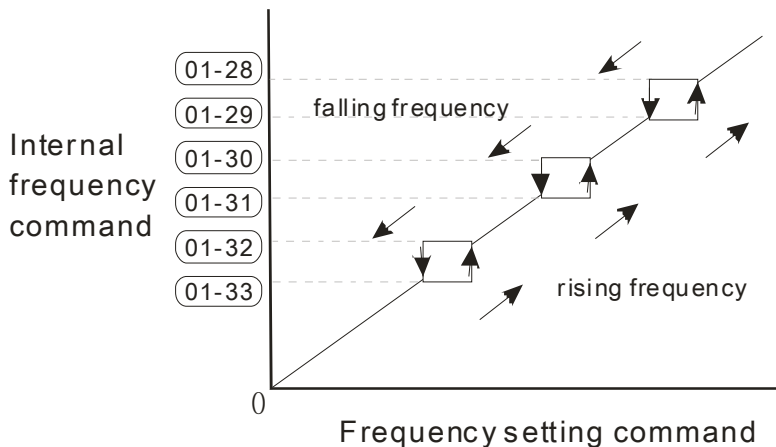

01-34 Zero-speed Mode

Factory Setting: 0

- Settings 0: Output waiting
- 1: Zero-speed operation
- 2: Fmin (Refer to Pr.01-07, 01-41)

- 📖 When the frequency is less than Fmin (Pr.01-07 or Pr.01-41), it will operate by this parameter.
- 📖 When it is set to 0, the AC motor drive will be in waiting mode without voltage output from terminals U/V/W.
- 📖 When setting 1, it will execute DC brake by Vmin(Pr.01-08 and Pr.01-42) in V/f, and SVC modes.
- 📖 When it is set to 2, the AC motor drive will run by Fmin (Pr.01-07, Pr.01-41) and Vmin (Pr.01-08, Pr.01-42) in V/F, SVC modes.
- 📖 In V/F, SVC modes

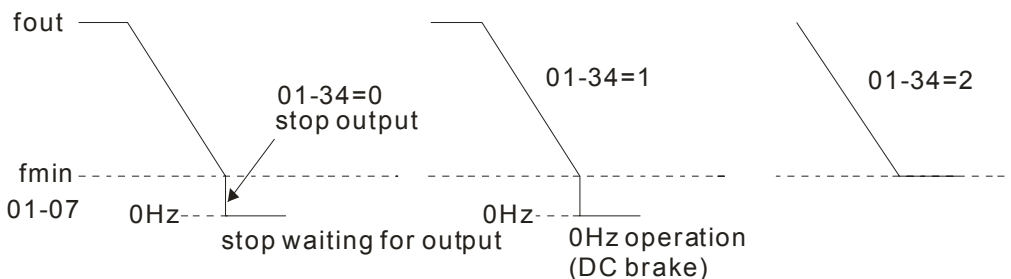

- 📖 In FOCPG mode, when Pr.01-34 is set to 2, it will act according Pr.01-34 setting.

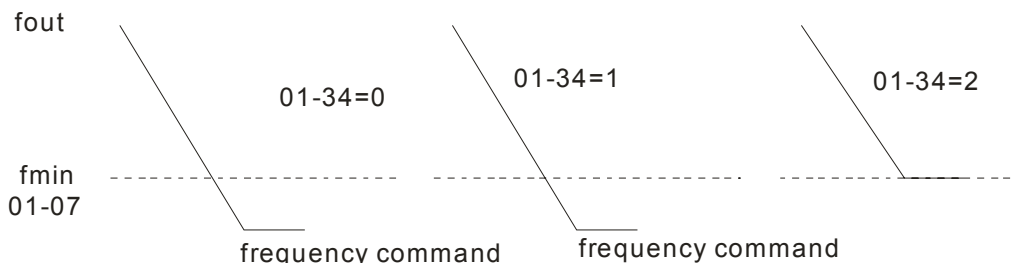

01-43 V/F Curve Selection

Factory Setting: 0

- Settings 0~15

- 📖 V/F curve can be selected from 15 kinds of default settings or set manually.
- 📖 Different kinds of V/F curves are shown in the table below. There are 15 kinds of V/F curve to be

chosen. Choose a V/F curve suitable for your application then set Pr01-43 by following the V/F curve chosen. The set values of Pr01-00 ~Pr01-08 can be verified and fine-tuned.

NOTE

1. If the V/F curve is not selected properly, it may result motor to generate insufficient torque or may lead to high current output due to overfluxing.
2. When the motor drive is reset by Pr00-02, Pr01-43 is reset as well.

Setting	SPEC.	Feature	Purpose
0	V/f curve determined	Constant torque	For normal application. This required torque for load is the same no matter the rotor speed of motor.
1	1.5 th V/F curve	Variable torque	curve, the torque in low speed is relatively low, which is not recommended V/F curve to the 2 power for high acceleration/deceleration application.
2	2 nd V/F curve		
3	60Hz (voltage saturation in 50Hz)	Constant torque	For normal application. This required torque for load is the same no matter the rotor speed of motor.
4	72Hz (voltage saturation in 60Hz)		
5	3 rd decreasing (50Hz)	Decreasing torque	For fans, pumps, the required torque derating relative to the load.
6	2 nd decreasing (50Hz)		
7	3 rd decreasing (60Hz)		
8	2 nd decreasing (60Hz)		
9	Mid. Starting torque (50Hz)	High starting torque	Select high starting torque when: <ul style="list-style-type: none"> ■ Wiring between the drive and motor(exceeds 150 m) ■ A large amount of starting torque is required (like lift) ■ An AC reactor is installed in the output side of the drive
10	High starting torque (50Hz)		
11	Mid. Starting torque (60Hz)		
12	High starting torque (60Hz)		
13	90Hz (voltage saturation in 60Hz)	Constant output operation	The curve for operation above 60Hz. To operate above 60Hz, the output voltage is fixed.
14	120Hz (voltage saturation in 60Hz)		
15	180Hz (voltage saturation in 60Hz)		

When setting to 0, refer to Pr.01-01~01-08 for motor 1 V/f curve. For motor 2, please refer to Pr.01-35~01-42.

When setting to 1 or 2, 2nd and 3rd voltage frequency setting are invalid.

When setting higher power V/f curve, it is lower torque at low frequency and is not suitable for rapid acceleration/deceleration. It is recommended Not to use this parameter for the rapid acceleration/deceleration.

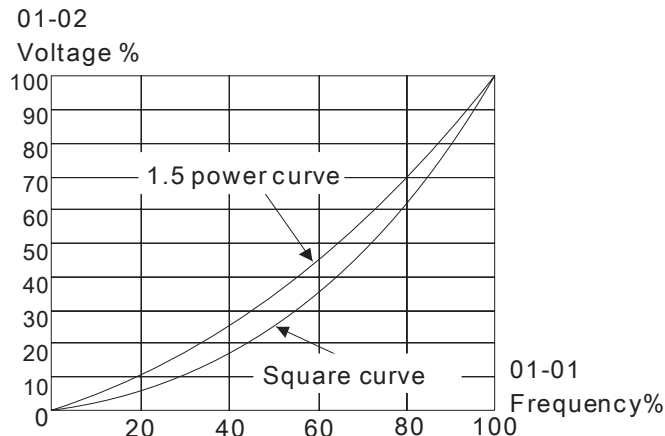

01-44 Optimal Acceleration/Deceleration Setting

Factory Setting: 0

- Settings
- 0: Linear accel./decel.
 - 1: Auto accel., linear decel.
 - 2: Linear accel., auto decel.
 - 3: Auto accel./decel. (auto calculate the accel./decel. time by actual load)
 - 4: Stall prevention by auto accel./decel. (limited by 01-12 to 01-21)

- 📖 Setting 0 Linear accel./decel.: it will accelerate/decelerate according to the setting of Pr.01-12~01-19.
- 📖 Setting to Auto accel./decel.: it can reduce the mechanical vibration and prevent the complicated auto-tuning processes. It won't stall during acceleration and no need to use brake resistor. In addition, it can improve the operation efficiency and save energy.
- 📖 Setting 3 Auto accel./decel. (auto calculate the accel./decel. time by actual load): it can auto detect the load torque and accelerate from the fastest acceleration time and smoothest start current to the setting frequency. In the deceleration, it can auto detect the load re-generation and stop the motor smoothly with the fastest decel. time.
- 📖 Setting 4 Stall prevention by auto accel./decel. (limited by 01-12 to 01-21): if the acceleration/deceleration is in the reasonable range, it will accelerate/decelerate by Pr.01-12~01-19. If the accel./decel. time is too short, the actual accel./decel. time is greater than the setting of accel./decel. time.

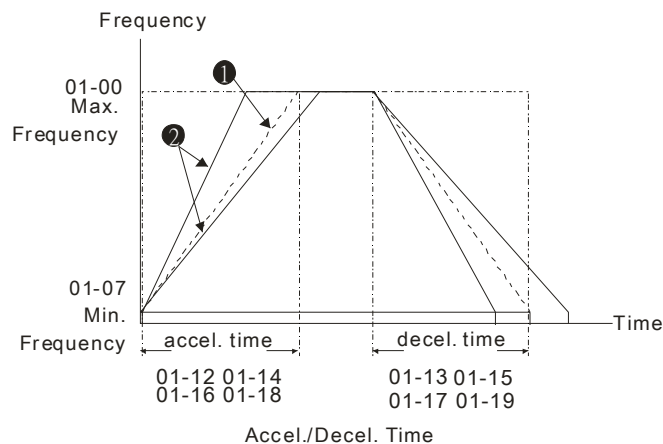

① When Pr.01-44 is set to 0.

② When Pr.01-44 is set to 3.

01-45 Time Unit for Acceleration/Deceleration and S Curve

Factory Setting: 0

- Settings
- 0: Unit 0.01 sec
 - 1: Unit 0.1 sec

01-46 Time for CANopen Quick Stop

Factory Setting: 1.00/1.0

- Settings
- Pr. 01-45=0: 0.00~600.00 sec
 - Pr. 01-45=1: 0.0~6000.0 sec

- 📖 It is used to set the time that decelerates from the max. operation frequency (Pr.01-00) to 0.00Hz in CANopen control.

01-47	Reserved
-------	----------

01-48	Reserved
-------	----------

01-49	Deceleration Method
-------	---------------------

Factory Setting: 0

Settings 0: Normal decel.

1: Over fluxing decel.

2: Traction energy control

 When Pr01-49=0, the deceleration or stop will according to original deceleration method.

 When Pr01-49=1: drive will control the deceleration time according to the Pr06-01 setting value and DC BUS voltage.

DC BUS >95% of Pr06-01 Over-voltage Stall Prevention setting value →enable Over fluxing deceleration method.

If the Pr06-01=0→Drive will enable Over fluxing deceleration method according to the operating voltage and DC BUS regenerative voltage This method will refer to the deceleration time setting and the actual deceleration time will longer than the deceleration time setting.

 Actual deceleration time will longer than the deceleration time setting because the Over-voltage Stall Prevention function.

 When Pr01-49=1, please used with the parameter Pr06-02=1 to get a better over voltage suppression effect during deceleration.

 Pr01-49=2: this function is based on the drives' ability to auto-adjust output frequency and voltage in order to get faster DC BUS energy consumption and the actual deceleration time will be as much as possible consistent with the deceleration parameter set up time. When real deceleration time does not conform to the expected deceleration time and cause an over-voltage errors, recommended that to use this setting.. .

02 Digital Input/Output Parameter

✎ This parameter can be set during operation.

02-00 2-wire/3-wire Operation Control

Factory Setting: 0

- Settings 0: 2 wire mode 1
 1: 2 wire mode 2
 2: 3 wire mode

📖 It is used to set the operation control method:

Pr.02-00	Control Circuits of the External Terminal
0 2-wire mode 1 FWD/STOP REV/STOP	
1 2-wire mode 2 RUN/STOP FWD/REV REV/FWD	
2 3-wire operation control	

02-01 Multi-function Input Command 1 (MI1)

(MI1= STOP command when in 3-wire operation control)

Factory Setting: 1

02-02 Multi-function Input Command 2 (MI2)

Factory Setting: 2

02-03 Multi-function Input Command 3 (MI3)

Factory Setting: 3

02-04 Multi-function Input Command 4 (MI4)

Factory Setting: 4

02-05 Multi-function Input Command 5 (MI5)

02-06 Multi-function Input Command 6 (MI6)

02-07 Multi-function Input Command 7 (MI7)

02-08 Multi-function Input Command 8 (MI8)

02-26 Input terminal of I/O extension card (MI10)

02-27 Input terminal of I/O extension card (MI11)

02-28 Input terminal of I/O extension card (MI12)

02-29	Input terminal of I/O extension card (MI13)
-------	---

02-30	Input terminal of I/O extension card (MI14)
-------	---

02-31	Input terminal of I/O extension card (MI15)
-------	---

Factory Setting: 0

Settings

- 0: no function
- 1: multi-step speed command 1/multi-step position command 1
- 2: multi-step speed command 2/multi-step position command 2
- 3: multi-step speed command 3/multi-step position command 3
- 4: multi-step speed command 4/multi-step position command 4
- 5: Reset
- 6: JOG command (By KPC-CC02 or external control)
- 7: acceleration/deceleration speed not allow
- 8: the 1st, 2nd acceleration/deceleration time selection
- 9: the 3rd, 4th acceleration/deceleration time selection
- 10: EF Input (Pr.07-20)
- 11: B.B input from external (Base Block)
- 12: Output stop
- 13: cancel the setting of the optimal acceleration/deceleration time
- 14: switch between motor 1 and motor 2
- 15: operation speed command from AVI1
- 16: operation speed command from ACI
- 17: operation speed command from AVI2
- 18: Emergency stop (Pr.07-20)
- 19: Digital up command
- 20: Digital down command
- 21: PID function disabled
- 22: Clear counter
- 23: Input the counter value (MI6)
- 24: FWD JOG command
- 25: REV JOG command
- 26: Reserved
- 27: Reserved
- 28: Emergency stop (EF1)
- 29: Signal confirmation for Y-connection
- 30: Signal confirmation for Δ -connection
- 31~37: Reserved
- 38: Disable write EEPROM function
- 39: Reserved
- 40: Force coast to stop
- 41: HAND switch
- 42: AUTO switch
- 43~48: Reserved
- 49: Drive enable
- 50: Slave dEb action to execute
- 51: Selection for PLC mode bit0
- 52: Selection for PLC mode bit1
- 53: Trigger CANopen quick stop
- 54: UVW Output Electromagnetic valve Switch
- 55: Brake release checking signal
- 56: Local/Remote Selection
- 57: Reserved
- 58: Enable fire mode (with RUN Command)
- 59: Enable fire mode (without RUN Command)
- 60: All motors disabled
- 61: Motor #1 disabled
- 62: Motor #2 disabled

- 63: Motor #3 disabled
- 64: Motor #4 disabled
- 65: Motor #5 disabled
- 66: Motor #6 disabled
- 67: Motor #7 disabled
- 68: Motor #8 disabled
- 69: Preheating Command

- 📖 This parameter selects the functions for each multi-function terminal.
- 📖 The terminals of Pr.02-26~Pr.02-29 are virtual and set as MI10~MI13 when using with optional card EMC-D42A. Pr.02-30~02-31 are virtual terminals.
- 📖 When being used as a virtual terminal, it needs to change the status (0/1: ON/OFF) of bit 8-15 of Pr.02-12 by digital keypad KPC-CC02 or communication.
- 📖 If Pr.02-00 is set to 3-wire operation control. Terminal MI1 is for STOP contact. Therefore, MI1 is not allowed for any other operation.
- 📖 Summary of function settings (Take the normally open contact for example, ON: contact is closed, OFF: contact is open)

Settings	Functions	Descriptions
0	No Function	
1	Multi-step speed command 1/ multi-step position command 1	15 step speeds could be conducted through the digital status of the 4 terminals, and 16 in total if the master speed is included. (Refer to Parameter set 4)
2	Multi-step speed command 2/ multi-step position command 2	
3	Multi-step speed command 3/ multi-step position command 3	
4	Multi-step speed command 4/ multi-step position command 4	
5	Reset	After the error of the drive is eliminated, use this terminal to reset the drive.
6	JOG Command	<p>This function is valid when the source of operation command is external terminals. Before executing this function, it needs to wait for the drive stop completely. During running, it can change the operation direction and STOP key on the keypad is valid. Once the external terminal receives OFF command, the motor will stop by the JOG deceleration time. Refer to Pr.01-20~01-22 for details.</p>

Settings	Functions	Descriptions															
7	Acceleration/deceleration Speed Inhibit	<p>When this function is enabled, acceleration and deceleration is stopped. After this function is disabled, the AC motor drive starts to accel./decel. from the inhibit point.</p>															
8	The 1 st , 2 nd acceleration or deceleration time selection	<p>The acceleration/deceleration time of the drive could be selected from this function or the digital status of the terminals; there are 4 acceleration/deceleration speeds in total for selection.</p>															
9	The 3 rd , 4 th acceleration or deceleration time selection	<table border="1"> <thead> <tr> <th>Mlx=9</th> <th>Mlx=8</th> <th>Accel./Decel.</th> </tr> </thead> <tbody> <tr> <td>OFF</td> <td>OFF</td> <td>1st Accel./Decel.</td> </tr> <tr> <td>OFF</td> <td>ON</td> <td>2nd Accel/Decel.</td> </tr> <tr> <td>ON</td> <td>OFF</td> <td>3rd Accel/Decel.</td> </tr> <tr> <td>ON</td> <td>ON</td> <td>4th Accel./Decel.</td> </tr> </tbody> </table>	Mlx=9	Mlx=8	Accel./Decel.	OFF	OFF	1st Accel./Decel.	OFF	ON	2 nd Accel/Decel.	ON	OFF	3 rd Accel/Decel.	ON	ON	4 th Accel./Decel.
Mlx=9	Mlx=8	Accel./Decel.															
OFF	OFF	1st Accel./Decel.															
OFF	ON	2 nd Accel/Decel.															
ON	OFF	3 rd Accel/Decel.															
ON	ON	4 th Accel./Decel.															
10	EF Input (EF: External fault)	<p>For external fault input. Motor drive will decelerate by Pr.07-20 setting, keypad will show EF. (It will have fault record when external fault occurs). Until the causes of fault are eliminated, the drive can keep running after resetting.</p>															
11	External B.B. Input (Base Block)	<p>When the contact of this function is ON, output of the drive will be cut off immediately, and the motor will be free run and keypad will display B.B. signal. Refer to Pr.07-08 for details.</p>															
12	Output Stop (Output pause)	<p>If the contact of this function is ON, output of the drive will be cut off immediately, and the motor will then be free run. And once it is turned to OFF, the drive will accelerate to the setting frequency.</p>															
13	Cancel the setting of the optimal accel./decel. time	<p>Before using this function, Pr.01-44 should be set to 01/02/03/04 first. When this function is enabled, OFF is for auto mode and ON is for linear accel./decel.</p>															

Settings	Functions	Descriptions
14	Switch between drive settings 1 and 2	When the contact of this function is ON: use motor 2 parameters. OFF: use motor 1 parameters.
15	Operation speed command form AVI	When the contact of this function is ON, the source of the frequency will force to be AVI. (If the operation speed commands are set to AVI1, ACI and AVI2 at the same time. The priority is AVI1 > ACI > AVI2)
16	Operation speed command form ACI	When the contact of this function is ON, the source of the frequency will force to be ACI. (If the operation speed commands are set to AVI1, ACI and AVI2 at the same time. The priority is AVI1 > ACI > AVI2)
17	Operation speed command form AUI	When the contact of this function is ON, the source of the frequency will force to be AUI. (If the operation speed commands are set to AVI1, ACI and AVI2 at the same time. The priority is AVI1 > ACI > AVI2)
18	Emergency Stop (07-20)	When the contact of this function is ON, the drive will ramp to stop by Pr.07-20 setting.
19	Digital Up command	When the contact of this function is ON, the frequency will be increased and decreased. If this function is constantly ON, the frequency will be increased/decreased by Pr.02-09/Pr.02-10.
20	Digital Down command	The frequency command returns to zero when the drive stops, and the display frequency is 0.00Hz. Select Pr11-00, Bit7=1, frequency is not saved.
21	PID function disabled	When the contact of this function is ON, the PID function is disabled.
22	Clear counter	When the contact of this function is ON, it will clear current counter value and display "0". Only when this function is disabled, it will keep counting upward.
23	Input the counter value (multi-function input command 6)	The counter value will increase 1 once the contact of this function is ON. It needs to be used with Pr.02-19.
24	FWD JOG command	When the contact is ON, the drive will execute forward Jog command.
25	REV JOG command	When the contact is ON the drive will execute reverse Jog command.
26	Reserved	
27	Reserved	
28	Emergency stop (EF1)	<p>When the contact is ON, the drive will execute emergency stop and display EF1 on the keypad. The motor won't run and be in the free run until the fault is cleared after pressing RESET" (EF: External Fault)</p> <p>The diagram shows the behavior of the drive during an emergency stop. It includes a graph of Voltage and Frequency over Time, and a signal timing diagram for Mix-GND, Reset, and Operation command. The graph shows that when the emergency stop signal is ON, the frequency ramps down to zero and the voltage drops. When the signal is OFF, the frequency ramps back up to the setting frequency and the voltage returns to its operating level. The timing diagram shows that the Mix-GND signal is ON during the emergency stop, the Reset signal is ON to clear the fault, and the Operation command is ON to restart the drive.</p>

Settings	Functions	Descriptions															
29	Signal confirmation for Y-connection	When is the contact of this function is ON, the drive will operate by 1st V/f.															
30	Signal confirmation for Δ-connection	When the contact of this function is ON, the drive will operate by 2nd V/f.															
31~37	Reserved																
38	Disable EEPROM write function (Parameters written disable)	When the contact of this function is ON, write to EEPROM is disabled. (Changed parameters will not be saved after power off)															
39	Reserved																
40	Force coast to stop	When the contact of this function is ON during the operation, the drive will free run to stop.															
41	HAND switch	1. When MI is switched to off status, it executes a STOP command. , If MI is switched to off during operation, the drive will also stop.															
42	AUTO switch	2. Using keypad KPC-CC01 to switch between HAND/AUTO, the drive will stop first then switch to the HAND or AUTO status. 3. On the digital keypad KPC-CC01, it will display current drive status (HAND/OFF/AUTO). <table border="1" data-bbox="815 891 1355 1066"> <thead> <tr> <th></th> <th>Bit 1</th> <th>Bit 0</th> </tr> </thead> <tbody> <tr> <td>OFF</td> <td>0</td> <td>0</td> </tr> <tr> <td>AUTO</td> <td>0</td> <td>1</td> </tr> <tr> <td>HAND</td> <td>1</td> <td>0</td> </tr> <tr> <td>OFF</td> <td>1</td> <td>1</td> </tr> </tbody> </table>		Bit 1	Bit 0	OFF	0	0	AUTO	0	1	HAND	1	0	OFF	1	1
	Bit 1	Bit 0															
OFF	0	0															
AUTO	0	1															
HAND	1	0															
OFF	1	1															
43~48	Reserved																
49	Drive enable	When drive=enable, RUN command is valid. When drive= disable, RUN command is invalid. When drive is in operation, motor coast to stop. This function will interact with MO=51															
50	Slave dEb action to execute	Input the message setting in this parameter when dEb occurs to Master. This will ensure dEb also occurs to Slave, then Master and Slave will stop simultaneously.															
51	Selection for PLC mode bit0	<table border="1" data-bbox="692 1424 1455 1599"> <thead> <tr> <th>PLC status</th> <th>Bit 1</th> <th>Bit 0</th> </tr> </thead> <tbody> <tr> <td>Disable PLC function (PLC 0)</td> <td>0</td> <td>0</td> </tr> <tr> <td>Trigger PLC to operation (PLC 1)</td> <td>0</td> <td>1</td> </tr> <tr> <td>Trigger PLC to stop (PLC 2)</td> <td>1</td> <td>0</td> </tr> <tr> <td>No function</td> <td>1</td> <td>1</td> </tr> </tbody> </table>	PLC status	Bit 1	Bit 0	Disable PLC function (PLC 0)	0	0	Trigger PLC to operation (PLC 1)	0	1	Trigger PLC to stop (PLC 2)	1	0	No function	1	1
PLC status	Bit 1	Bit 0															
Disable PLC function (PLC 0)	0	0															
Trigger PLC to operation (PLC 1)	0	1															
Trigger PLC to stop (PLC 2)	1	0															
No function	1	1															
52	Selection for PLC mode bit1																
53	Enable CANopen quick stop	When this function is enabled under CANopen control, it will change to quick stop. Refer to Chapter 15 for more details.															
54	UVW magnetic contactor ON/OFF	To receive confirmation signals while there is UVW magnetic contactor during output.															
55	Brake release checking signal	This parameter needs to be used with P02-56. The main purpose is to make sure if mechanical brake works or not after triggering brake release command. If the action is right, mechanical brake will give signal to MI terminal. Please check time sequence chart for reference.															

Settings	Functions	Descriptions						
56	LOCAL/REMOTE Selection	Use Pr.00-29 to select for LOCAL/REMOTE mode (refer to Pr.00-29). When Pr.00-29 is not set to 0, on the digital keypad KPC-CC01 it will display LOC/REM status. (It will display on the KPC-CC01 if the firmware version is above version 1.021). <table border="1" style="margin-left: auto; margin-right: auto;"> <tr> <td></td> <td>Bit 0</td> </tr> <tr> <td>REM</td> <td>0</td> </tr> <tr> <td>LOC</td> <td>1</td> </tr> </table>		Bit 0	REM	0	LOC	1
	Bit 0							
REM	0							
LOC	1							
57	Reserved							
58	Enable fire mode with RUN Command	Enable this function under fire mode to force the drive to run (while there is RUN COMMAND).						
59	Enable fire mode without RUN Command	Enable this function under fire mode to force the drive to run (while there isn't RUN COMMAND).						
60	Disable all the motors	When the multi-motor circulative control is enable, all motors will park freely, when the function terminal set to be ON.						
61	Disable Motor#1	These functions work with multi-motor circulative control, motor #1 to # 8 can be set to park freely. If any of Auxiliary Motor#1 to Motor#8 is out of order or under maintenance, enable this terminal to bypass that motor.						
62	Disable Motor#2							
63	Disable Motor#3							
64	Disable Motor#4							
65	Disable Motor#5							
66	Disable Motor#6							
67	Disable Motor#7							
68	Disable Motor#8							
69	Preheating Command	When the function terminal is setting to ON, if the preheating function is open and drive is in STOP status, the preheating function is executed; until the contact status (OFF) or drive status is turned to RUN, the preheating function is stop. Please refer to Pr.02-72~73 for detail.						

↗ **02-09** UP/DOWN Key Mode

Factory Setting: 0

Settings 0: Up/down by the accel/decel time
 1: Up/down constant speed (Pr.02-10)

↗ **02-10** Constant speed. The Accel. /Decel. Speed of the UP/DOWN Key

Factory Setting: 0.001

Settings 0.001~1.000Hz/ms

📖 These settings are used when multi-function input terminals are set to 19/20. Refer to Pr.02-09 and 02-10 for the frequency up/down command.

📖 Pr11-00, Bit7=1, frequency command is not saved. The frequency command returns to zero when the drive stops, and the display frequency is 0.00Hz. The frequency command

increase/decrease by using Up/Down key is effective only when the drive is at Running status.

- Pr.02-09 set to 0: it will increase/decrease frequency command (F) by the setting of acceleration/deceleration (Pr.01-12~01-19)

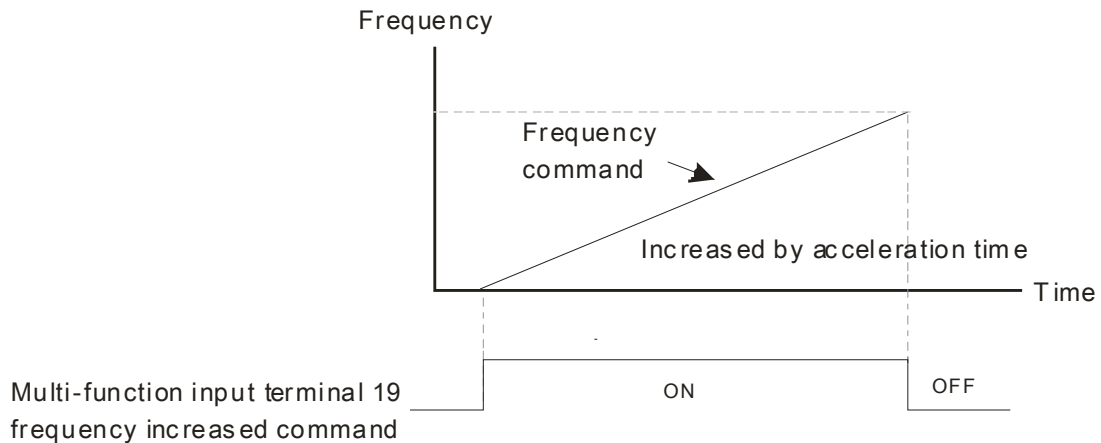

- Pr.02-09 set to 1: use multi-function input terminal ON/OFF to increase/decrease the frequency command (F) according to the setting of Pr.02.10 (0.01~1.00Hz/ms).

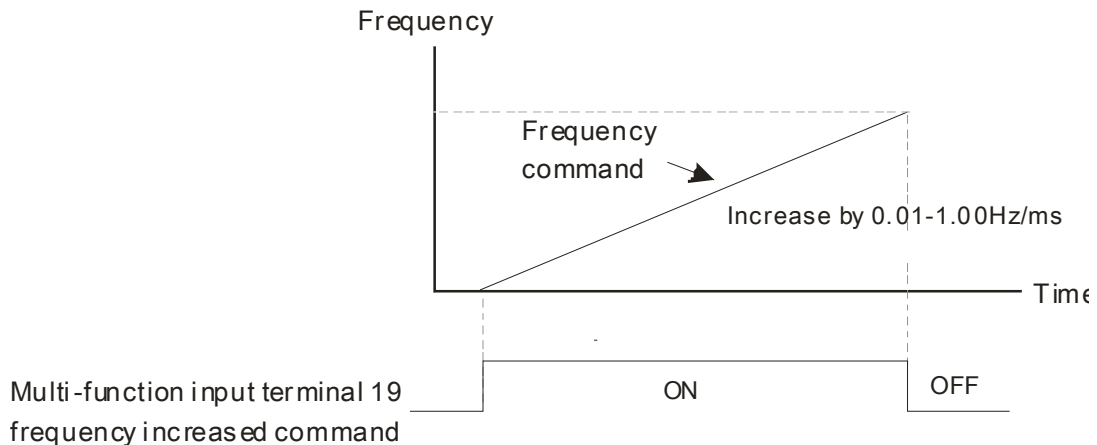

02-11 Digital Input Response Time

Factory Setting: 0.005

Settings 0.000~30.000 sec

- This parameter is used to set the response time of digital input terminals FWD, REV and MI1~MI8.
- It is used for digital input terminal signal delay and confirmation. The delay time is confirmation time to prevent some uncertain interference that would cause error in the input of the digital terminals. Under this condition, confirmation for this parameter would improve effectively, but the response time will be somewhat delayed.
- When using MI8 as encoder pulse feedback input, this parameter will not be referred.

02-12 Digital Input Operation Setting

Factory Setting: 0000h

Settings 0000h~FFFFh (0: N.O ; 1: N.C)

- The setting of this parameter is in hexadecimal.
- This parameter is to set the status of multi-function input signal (0: Normal Open ; 1: Normal Close) and it is not affected by the SINK/SOURCE status.

Bit0 is for FWD terminal, bit1 is for REV terminal and Bit2 to Bit15 is for MI1 to MI14.

User can change terminal status by communicating.

For example, MI1 is set to 1 (multi-step speed command 1), MI2 is set to 2 (multi-step speed command 2). Then the forward + 2nd step speed command=1001(binary)=9 (Decimal).

Pr.02-12=9 needs to be set by communication to run forward with 2nd step speed. No need to wire any multi-function terminal.

Bit15	Bit14	Bit13	Bit12	Bit11	Bit10	Bit9	Bit8	Bit7	Bit6	Bit5	Bit4	Bit3	Bit2	Bit1	Bit0
MI14	MI13	MI12	MI11	MI10	MI9	MI8	MI7	MI6	MI5	MI4	MI3	MI2	MI1	⊗	⊗

Through the Pr11-42, Bit 1, it could make setting of FWD/REV terminals whether are controlled by Pr02-12, Bit 0 & 1.

↗	02-13	Multi-function Output 1 (Relay1)	Factory Setting: 11
↗	02-14	Multi-function Output 2 (Relay2)	Factory Setting: 1
↗	02-15	Multi-function Output 3 (Relay3)	Factory Setting: 66
↗	02-36	Output terminal of I/O extension card (MO10) or (RA10)	
↗	02-37	Output terminal of I/O extension card (MO11) or (RA11)	
↗	02-38	Output terminal of I/O extension card (MO12) or (RA12)	
↗	02-39	Output terminal of I/O extension card (MO13) or (RA13)	
↗	02-40	Output terminal of I/O extension card (MO14) or (RA14)	
↗	02-41	Output terminal of I/O extension card (MO15) or (RA15)	
↗	02-42	Output terminal of I/O extension card (MO16)	
↗	02-43	Output terminal of I/O extension card (MO17)	
↗	02-44	Output terminal of I/O extension card (MO18)	
↗	02-45	Output terminal of I/O extension card (MO19)	
↗	02-46	Output terminal of I/O extension card (MO20)	Factory Setting: 0

Settings

- 0: No function
- 1: Operation Indication
- 2: Operation speed attained
- 3: Desired frequency attained 1 (Pr.02-22)
- 4: Desired frequency attained 2 (Pr.02-24)
- 5: Zero speed (Frequency command)
- 6: Zero speed, include STOP (Frequency command)
- 7: Over torque 1 (Pr.06-06~06-08)
- 8: Over torque 2 (Pr.06-09~06-11)
- 9: Drive is ready
- 10: Low voltage warning (LV) (Pr.06-00)

- 11: Malfunction indication
- 12: Mechanical brake release (Pr.02-32)
- 13: Overheat warning (Pr.06-15)
- 14: Software brake signal indication (Pr.07-00)
- 15: PID feedback error
- 16: Slip error (oSL)
- 17: Terminal count value attained (Pr.02-20; not return to 0)
- 18: Preliminary count value attained (Pr.02-19; returns to 0)
- 19: Base Block
- 20: Warning output
- 21: Over voltage warning
- 22: Over-current stall prevention warning
- 23: Over-voltage stall prevention warning
- 24: Operation mode indication
- 25: Forward command
- 26: Reverse command
- 27: Output when current \geq Pr.02-33 (\geq 02-33)
- 28: Output when current \leq Pr.02-33 (\leq 02-33)
- 29: Output when frequency \geq Pr.02-34 (\geq 02-34)
- 30: Output when frequency \leq Pr.02-34 (\leq 02-34)
- 31: Y-connection for the motor coil
- 32: Δ -connection for the motor coil
- 33: Zero speed (actual output frequency)
- 34: Zero speed include stop (actual output frequency)
- 35: Error output selection 1 (Pr.06-23)
- 36: Error output selection 2 (Pr.06-24)
- 37: Error output selection 3 (Pr.06-25)
- 38: Error output selection 4 (Pr.06-26)
- 39: Reserved
- 40: Speed attained (including Stop)
- 41~43: Reserved
- 44: Low current output (Pr.06-71 to Pr.06-73)
- 45: UVW Output Electromagnetic valve On/Off Switch
- 46: Reserved
- 47: Closed brake output
- 48: Reserved
- 49: Reserved
- 50: Output for CANopen control
- 51: As analog output control for InnerCOM
- 52: Output for RS485
- 53: Fire mode indication
- 54: Bypass fire mode indication

- 55: Motor #1 Output
- 56: Motor #2 Output
- 57: Motor #3 Output
- 58: Motor#4 Output
- 59: Motor#5 Output
- 60: Motor #6 Output
- 61: Motor#7 Output
- 62: Motor#8 Output
- 63~65: Reserved
- 66: SO contact A (N.O.)
- 67: Analog input signal level achieved
- 68: SO contact B (N.C.)
- 69: Output Command of Preheating

- 📖 This parameter is used for setting the function of multi-function terminals.
- 📖 Pr.02-36~Pr.02-41 requires additional extension cards to display the parameters, the choices of optional cards are EMC-D42A and EMC-R6AA.
- 📖 The optional card EMC-D42A provides 2 output terminals and can be used with Pr.02-36~02-37.
- 📖 The optional card EMC-R6AA provides 6 output terminals and can be used with Pr.02-36~02-41.
- 📖 Summary of function settings (Take the normally open contact for example, ON: contact is closed, OFF: contact is open)

Settings	Functions	Descriptions
0	No Function	
1	Operation Indication	Active when the drive is not at STOP.
2	Master Frequency Attained	Active when the AC motor drive reaches the output frequency setting.
3	Desired Frequency Attained 1 (Pr.02-22)	Active when the desired frequency (Pr.02-22) is attained.
4	Desired Frequency Attained 2 (Pr.02-24)	Active when the desired frequency (Pr.02-24) is attained.
5	Zero Speed (frequency command)	Active when frequency command =0. (the drive should be at RUN mode)
6	Zero Speed with Stop (frequency command)	Active when frequency command =0 or stop.
7	Over Torque 1	Active when detecting over-torque. Refer to Pr.06-07 (over-torque detection level-OT1) and Pr.06-08 (over-torque detection time-OT1). Refer to Pr.06-06~06-08.
8	Over Torque 2	Active when detecting over-torque. Refer to Pr.06-10 (over-torque detection level-OT2) and Pr.06-11 (over-torque detection time-OT2). Refer to Pr.06-09~06-11.
9	Drive Ready	Active when the drive is ON and no abnormality detected.
10	Low voltage warn (Lv)	Active when the DC Bus voltage is too low. (refer to Pr.06-00 low

Settings	Functions	Descriptions
		voltage level)
11	Malfunction Indication	Active when fault occurs (except Lv stop).
12	Mechanical Brake Release (Pr.02-32)	When drive runs after Pr.02-32, it will be ON. This function should be used with DC brake and it is recommended to use contact "b" (N.C).
13	Overheat	Active when IGBT or heat sink overheats to prevent OH turn off the drive. (refer to Pr.06-15)
14	Software Brake Signal Indication	Active when the soft brake function is ON. (refer to Pr.07-00)
15	PID Feedback Error	Active when the feedback signal is abnormal.
16	Slip Error (oSL)	Active when the slip error is detected.
17	Terminal Count Value Attained (Pr.02-20; not return to 0)	Active when the counter reaches Terminal Counter Value (Pr.02-19). This contact won't active when Pr.02-20>Pr.02-19.
18	Preliminary Counter Value Attained (Pr.02-19; returns to 0)	Active when the counter reaches Preliminary Counter Value (Pr.02-19).
19	External Base Block input (B.B.)	Active when the output of the AC motor drive is shut off during base block.
20	Warning Output	Active when the warning is detected.
21	Over-voltage Warning	Active when the over-voltage is detected.
22	Over-current Stall Prevention Warning	Active when the over-current stall prevention is detected.
23	Over-voltage Stall prevention Warning	Active when the over-voltage stall prevention is detected.
24	Operation Mode Indication	Active when the operation command is controlled by external terminal. (Pr.00-21≠0)
25	Forward Command	Active when the operation direction is forward.
26	Reverse Command	Active when the operation direction is reverse.
27	Output when Current >= Pr.02-33	Active when current is >= Pr.02-33.
28	Output when Current < Pr.02-33	Active when current is < Pr.02-33
29	Output when frequency >= Pr.02-34	Active when frequency is >= Pr.02-34.
30	Output when Frequency < Pr.02-34	Active when frequency is <Pr.02-34.
31	Y-connection for the Motor Coil	Active when PR.05-24=1, when frequency output is lower than Pr.05-23 minus 2Hz, continues longer than 05-25.

Settings	Functions	Descriptions
32	△-connection for the Motor Coil	Active when PR.05-24=1, when frequency output is higher than Pr.05-23 plus 2Hz, continues longer than 05-25.
33	Zero Speed (actual output frequency)	Active when the actual output frequency is 0. (the drive should be at RUN mode)
34	Zero Speed with Stop (actual output frequency)	Active when the actual output frequency is 0 or Stop.
35	Error Output Selection 1 (Pr.06-23)	Active when Pr.06-23 is ON.
36	Error Output Selection 2 (Pr.06-24)	Active when Pr.06-24 is ON.
37	Error Output Selection 3 (Pr.06-25)	Active when Pr.06-25 is ON.
38	Error Output Selection 4 (Pr.06-26)	Active when Pr.06-26 is ON.
39	Reserved	
40	Speed Attained (including zero speed)	Active when the output frequency reaches frequency setting or stop.
41~43	Reserved	
44	Low Current Output	This function needs to be used with Pr.06-71 ~ Pr.06-73
45	UVW Phase Magnet Contractor ON/ OFF Switch	<p>1. Under FOC PG control mode, set MI=49 (drive enable) and MO=45 (electromagnetic contractor ON/OFF switch), then the magnetic contractor will follow the drive status to be ON or OFF.</p> <p>2. For brake control, set MO=12 (mechanical brake release), Pr.02-31=T1 sec (mechanical brake delay time); then enable/disable DC braking by set 07-01 (DC brake current) to any level except 0 and set Pr.07-02 = T2 (DC brake time at start up) and Pr.07-03 = T2 (DC brake current at stop). It is recommend to set T2 >T1 and try to activate brake control during zero-speed status.</p>

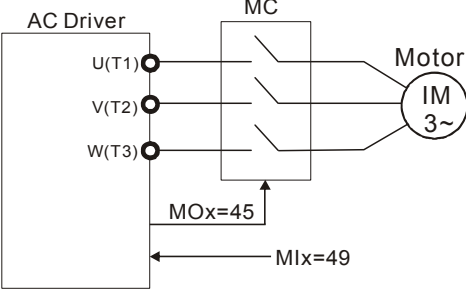
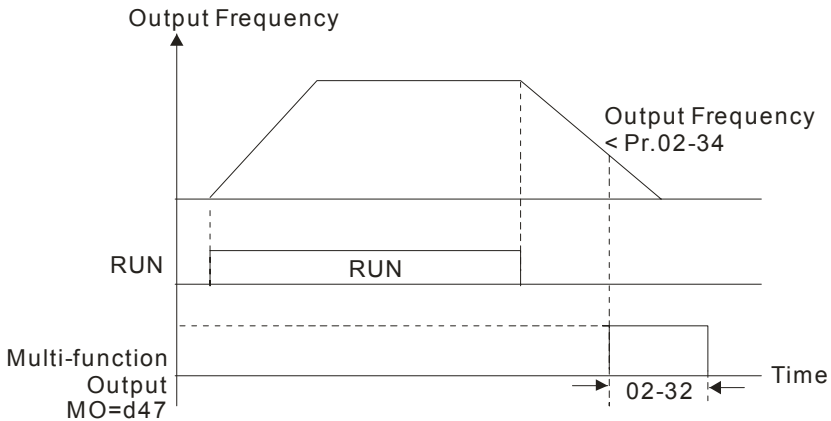
Settings	Functions	Descriptions																																																
																																																		
46	Reserved																																																	
47	Brake Release at Stop	<p>When drive stops, the corresponding multi-function terminal will be ON if the frequency is less than Pr.02-34. After it is ON, it will be OFF when brake delay time exceeds Pr.02-32.</p> 																																																
48~49	Reserved																																																	
50	Output for CANopen control	<p>Control multi-function output terminals through CANopen. If to control RY2, then the Pr02-14 = 50. The mapping table of the CANopen DO is below:</p> <table border="1" data-bbox="644 1330 1490 2024"> <thead> <tr> <th>physical terminal</th> <th>Setting of related parameters</th> <th>Attribute</th> <th>Corresponding Index</th> </tr> </thead> <tbody> <tr> <td>RY1</td> <td>P2-13 = 50</td> <td>RW</td> <td>The bit 0 at 2026-41</td> </tr> <tr> <td>RY2</td> <td>P2-14 = 50</td> <td>RW</td> <td>The bit 1 at 2026-41</td> </tr> <tr> <td>MO1</td> <td>P2-16 = 50</td> <td>RW</td> <td>The bit 2 at 2026-41</td> </tr> <tr> <td>MO2</td> <td>P2-17 = 50</td> <td>RW</td> <td>The bit 3 at 2026-41</td> </tr> <tr> <td>MO10</td> <td rowspan="2">P2-36 = 50</td> <td rowspan="2">RW</td> <td>The bit 4 at 2026-41</td> </tr> <tr> <td>RY10</td> <td>The bit 5 at 2026-41</td> </tr> <tr> <td>MO11</td> <td rowspan="2">P2-37 = 50</td> <td rowspan="2">RW</td> <td>The bit 6 at 2026-41</td> </tr> <tr> <td>RY11</td> <td>The bit 7 at 2026-41</td> </tr> <tr> <td>RY12</td> <td>P2-38 = 50</td> <td>RW</td> <td>The bit 8 at 2026-41</td> </tr> <tr> <td>RY13</td> <td>P2-39 = 50</td> <td>RW</td> <td>The bit 9 at 2026-41</td> </tr> <tr> <td>RY14</td> <td>P2-40 = 50</td> <td>RW</td> <td>The bit 10 at 2026-41</td> </tr> <tr> <td>RY15</td> <td>P2-41 = 50</td> <td>RW</td> <td>The bit 0 at 2026-41</td> </tr> </tbody> </table> <p>Refer to Chapter 15-3-5 for more information.</p>	physical terminal	Setting of related parameters	Attribute	Corresponding Index	RY1	P2-13 = 50	RW	The bit 0 at 2026-41	RY2	P2-14 = 50	RW	The bit 1 at 2026-41	MO1	P2-16 = 50	RW	The bit 2 at 2026-41	MO2	P2-17 = 50	RW	The bit 3 at 2026-41	MO10	P2-36 = 50	RW	The bit 4 at 2026-41	RY10	The bit 5 at 2026-41	MO11	P2-37 = 50	RW	The bit 6 at 2026-41	RY11	The bit 7 at 2026-41	RY12	P2-38 = 50	RW	The bit 8 at 2026-41	RY13	P2-39 = 50	RW	The bit 9 at 2026-41	RY14	P2-40 = 50	RW	The bit 10 at 2026-41	RY15	P2-41 = 50	RW	The bit 0 at 2026-41
physical terminal	Setting of related parameters	Attribute	Corresponding Index																																															
RY1	P2-13 = 50	RW	The bit 0 at 2026-41																																															
RY2	P2-14 = 50	RW	The bit 1 at 2026-41																																															
MO1	P2-16 = 50	RW	The bit 2 at 2026-41																																															
MO2	P2-17 = 50	RW	The bit 3 at 2026-41																																															
MO10	P2-36 = 50	RW	The bit 4 at 2026-41																																															
RY10			The bit 5 at 2026-41																																															
MO11	P2-37 = 50	RW	The bit 6 at 2026-41																																															
RY11			The bit 7 at 2026-41																																															
RY12	P2-38 = 50	RW	The bit 8 at 2026-41																																															
RY13	P2-39 = 50	RW	The bit 9 at 2026-41																																															
RY14	P2-40 = 50	RW	The bit 10 at 2026-41																																															
RY15	P2-41 = 50	RW	The bit 0 at 2026-41																																															

Settings	Functions	Descriptions																																																
51	Output for RS-485	For RS485 output.																																																
52	Output for communication card	For communication output of communication cards (CMC-MOD01, CMC-EIP01, CMC-PN01 and CMC-DN01)																																																
		<table border="1"> <thead> <tr> <th>Physical terminal</th> <th>Setting of related parameters</th> <th>Attribute</th> <th>Corresponding Address</th> </tr> </thead> <tbody> <tr> <td>RY1</td> <td>P2-13 = 51</td> <td>RW</td> <td>The Bit 0 of 2640</td> </tr> <tr> <td>RY2</td> <td>P2-14 = 51</td> <td>RW</td> <td>The Bit 1 of 2640</td> </tr> <tr> <td></td> <td>P2-15 = 51</td> <td>RW</td> <td>The Bit 2 of 2640</td> </tr> <tr> <td>MO1</td> <td>P2-16 = 51</td> <td>RW</td> <td>The Bit 3 of 2640</td> </tr> <tr> <td>MO2</td> <td>P2-17 = 51</td> <td>RW</td> <td>The Bit 4 of 2640</td> </tr> <tr> <td>MO3</td> <td>P2-18 = 51</td> <td>RW</td> <td>The Bit 5 of 2640</td> </tr> <tr> <td>MO4</td> <td>P2-19 = 51</td> <td>RW</td> <td>The Bit 6 of 2640</td> </tr> <tr> <td>MO5</td> <td>P2-20 = 51</td> <td>RW</td> <td>The Bit 7 of 2640</td> </tr> <tr> <td>MO6</td> <td>P2-21 = 51</td> <td>RW</td> <td>The Bit 8 of 2640</td> </tr> <tr> <td>MO7</td> <td>P2-22 = 51</td> <td>RW</td> <td>The Bit 9 of 2640</td> </tr> <tr> <td>MO8</td> <td>P2-23 = 51</td> <td>RW</td> <td>The Bit 10 of 2640</td> </tr> </tbody> </table>	Physical terminal	Setting of related parameters	Attribute	Corresponding Address	RY1	P2-13 = 51	RW	The Bit 0 of 2640	RY2	P2-14 = 51	RW	The Bit 1 of 2640		P2-15 = 51	RW	The Bit 2 of 2640	MO1	P2-16 = 51	RW	The Bit 3 of 2640	MO2	P2-17 = 51	RW	The Bit 4 of 2640	MO3	P2-18 = 51	RW	The Bit 5 of 2640	MO4	P2-19 = 51	RW	The Bit 6 of 2640	MO5	P2-20 = 51	RW	The Bit 7 of 2640	MO6	P2-21 = 51	RW	The Bit 8 of 2640	MO7	P2-22 = 51	RW	The Bit 9 of 2640	MO8	P2-23 = 51	RW	The Bit 10 of 2640
		Physical terminal	Setting of related parameters	Attribute	Corresponding Address																																													
		RY1	P2-13 = 51	RW	The Bit 0 of 2640																																													
		RY2	P2-14 = 51	RW	The Bit 1 of 2640																																													
			P2-15 = 51	RW	The Bit 2 of 2640																																													
		MO1	P2-16 = 51	RW	The Bit 3 of 2640																																													
		MO2	P2-17 = 51	RW	The Bit 4 of 2640																																													
		MO3	P2-18 = 51	RW	The Bit 5 of 2640																																													
		MO4	P2-19 = 51	RW	The Bit 6 of 2640																																													
		MO5	P2-20 = 51	RW	The Bit 7 of 2640																																													
		MO6	P2-21 = 51	RW	The Bit 8 of 2640																																													
MO7	P2-22 = 51	RW	The Bit 9 of 2640																																															
MO8	P2-23 = 51	RW	The Bit 10 of 2640																																															
53	Fire mode indication	When #58 or #59 is enabled, this function will work.																																																
54	By pass fire mode indication	When bypass function is enabled in the fire mode, this contact will work.																																																
55	Motor #1 output	When setting multi-motor circulative function, the multi-function output terminal will automatically set up Pr02-13~Pr02-15 and Pr02-36~Pr02-40 in accordance with Pr12-01's setting.																																																
56	Motor #2 output																																																	
57	Motor #3 output																																																	
58	Motor #4 output																																																	
59	Motor #5 output																																																	
60	Motor #6 output																																																	
61	Motor #7 output																																																	
62	Motor #8 output																																																	
63~65	Reserved																																																	
66	SO contact A (N.O.)	<table border="1"> <thead> <tr> <th rowspan="2">Status of drive</th> <th colspan="2">Status of safety output</th> </tr> <tr> <th>N.O. (MO=66)</th> <th>N.C. (MO=68)</th> </tr> </thead> <tbody> <tr> <td>Normal</td> <td>Broken circuit (Open)</td> <td>Short circuit (Close)</td> </tr> <tr> <td>STO</td> <td>Short circuit (Close)</td> <td>Broken circuit (Open)</td> </tr> <tr> <td>STL1~STL3</td> <td>Short circuit (Close)</td> <td>Broken circuit (Open)</td> </tr> </tbody> </table>	Status of drive	Status of safety output		N.O. (MO=66)	N.C. (MO=68)	Normal	Broken circuit (Open)	Short circuit (Close)	STO	Short circuit (Close)	Broken circuit (Open)	STL1~STL3	Short circuit (Close)	Broken circuit (Open)																																		
Status of drive	Status of safety output																																																	
	N.O. (MO=66)	N.C. (MO=68)																																																
Normal	Broken circuit (Open)	Short circuit (Close)																																																
STO	Short circuit (Close)	Broken circuit (Open)																																																
STL1~STL3	Short circuit (Close)	Broken circuit (Open)																																																
68	SO contact B (N.C.)																																																	
67	Analog input signal level achieved	Multi-function output terminals operate when analog input signal level is between high level and low level. 03-44: Select the analog signal channel, AVI, ACI, and AUI which is going to be compared. 03-45: The high level of analog input, factory setting is 50%.																																																

Settings	Functions	Descriptions
		03-46: The low level of analog input, factory setting is 10%. If analog input > 03-45, then multi-function output terminal operates. If analog input < 03-46, then multi-function output terminal stops outputting.
69	Output Command of Preheating	When MI =69 and the terminal contact is ON, the preheat function will be activated while the motor drive is at STOP. The MO terminal will indicate the preheating output. When the MI terminal contact is OFF or when the motor drive is at RUN, the preheat function and the output command will be deactivated. See Pr02-72 and Pr02-73 for more information.

02-16 Reserved

02-17 Reserved

✎ **02-18** Multi-function Output Setting

Factory Setting: 0000h

Settings 0000h~FFFFh (0:N.O. ; 1:N.C.)

📖 The setting of this parameter is in hexadecimal.

📖 This parameter is set via bit setting. If a bit is 1, the corresponding multi-function output acts in the opposite way.

Example:

If Pr02-13=1 and Pr02-18=0, Relay 1 is ON when the drive runs and is open when the drive is stopped.

If Pr02-13=1 and Pr02-18=1, Relay 1 is open when the drive runs and is closed when the drive is stopped.

Bit setting

bit15	bit14	bit13	bit12	bit11	bit10	bit9	bit8	bit7	bit6	bit5	bit4	bit3	bit2	bit1	bit0
MO20	MO19	MO18	MO17	MO16	MO15	MO14	MO13	MO12	MO11	MO10	MO2	MO1	Reserved	RY2	RY1

✎ **02-19** Terminal Counting Value Attained (return to 0)

Factory Setting: 0

Settings 0~65500

📖 The counter trigger can be set by the multi-function terminal MI6 (set Pr.02-06 to 23). Upon completion of counting, the specified multi-function output terminal will be activated (Pr.02-13~02-14, Pr.02-36, 02-37 is set to 18). Pr.02-19 can't be set to 0.

📖 When the display shows c5555, the drive has counted 5,555 times. If display shows c5555•, it means that real counter value is between 55,550 to 55,559.

✎ **02-20** Preliminary Counting Value Attained (not return to 0)

Factory Setting: 0

Settings 0~65500

📖 When the counter value counts from 1 and reaches this value, the corresponding multi-function output terminal will be activated, provided one of Pr. 02-13, 02-14, 02-36, 02-37 set to 17 (Preliminary Count Value Setting). This parameter can be used for the end of the counting to

make the drive runs from the low speed to stop.

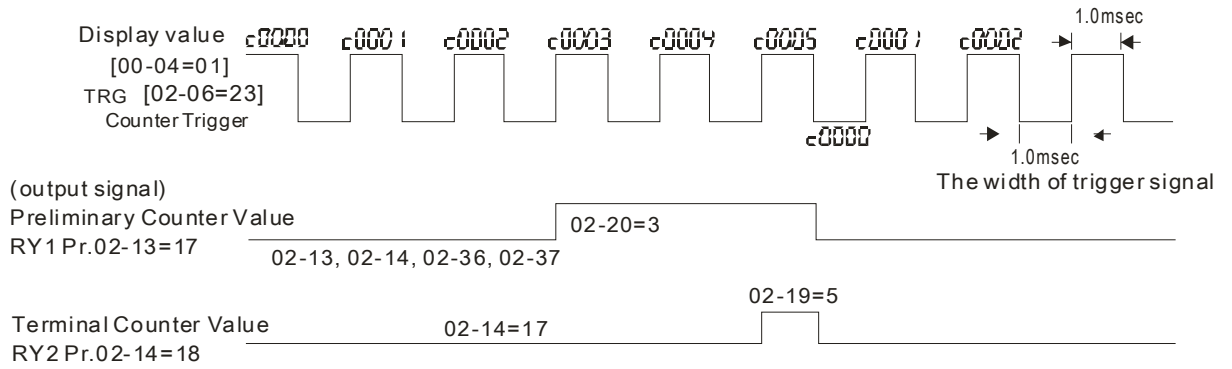

➤ **02-21** Reserved

➤ **02-22** Desired Frequency Attained 1
 Factory Setting: 60.00/50.00
 Settings 0.00~599.00Hz

➤ **02-23** The Width of the Desired Frequency Attained 1
 Factory Setting: 2.00
 Settings 0.00~599.00Hz

➤ **02-24** Desired Frequency Attained 2
 Factory Setting: 60.00/50.00
 Settings 0.00~599.00Hz

➤ **02-25** The Width of the Desired Frequency Attained 2
 Factory Setting: 2.00
 Settings 0.00~599.00Hz

📖 Once output frequency reaches desired frequency and the corresponding multi-function output terminal is set to 3 or 4 (Pr.02-13, 02-14, 02-36, and 02-37), this multi-function output terminal will be ON.

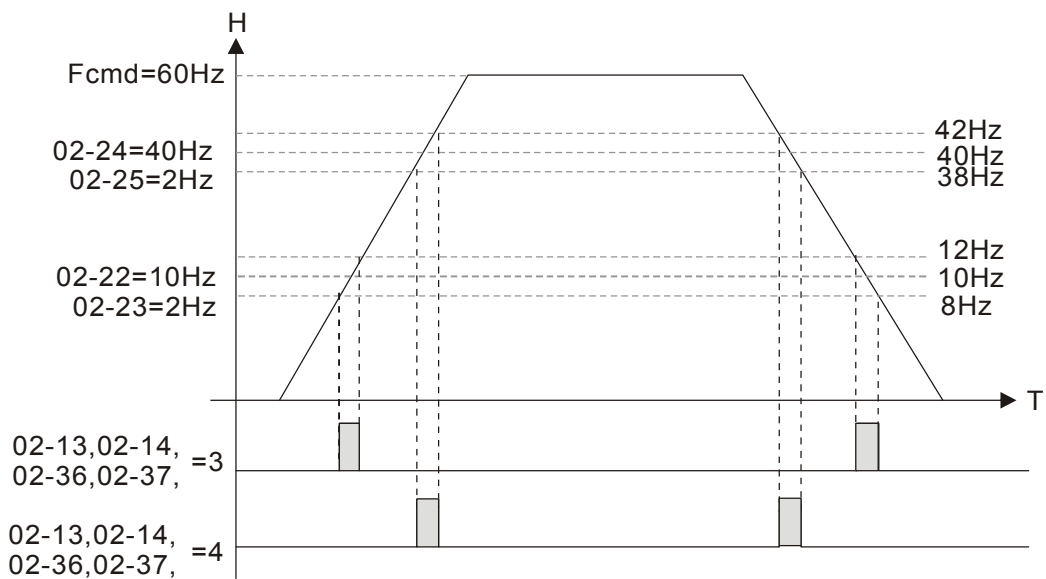

02-32 Brake Delay Time

Settings 0.000~65.000 sec

When the AC motor drive runs after Pr.02-32 delay time, the corresponding multi-function output terminal (12: mechanical brake release) will be ON. It has to use this function with DC brake.

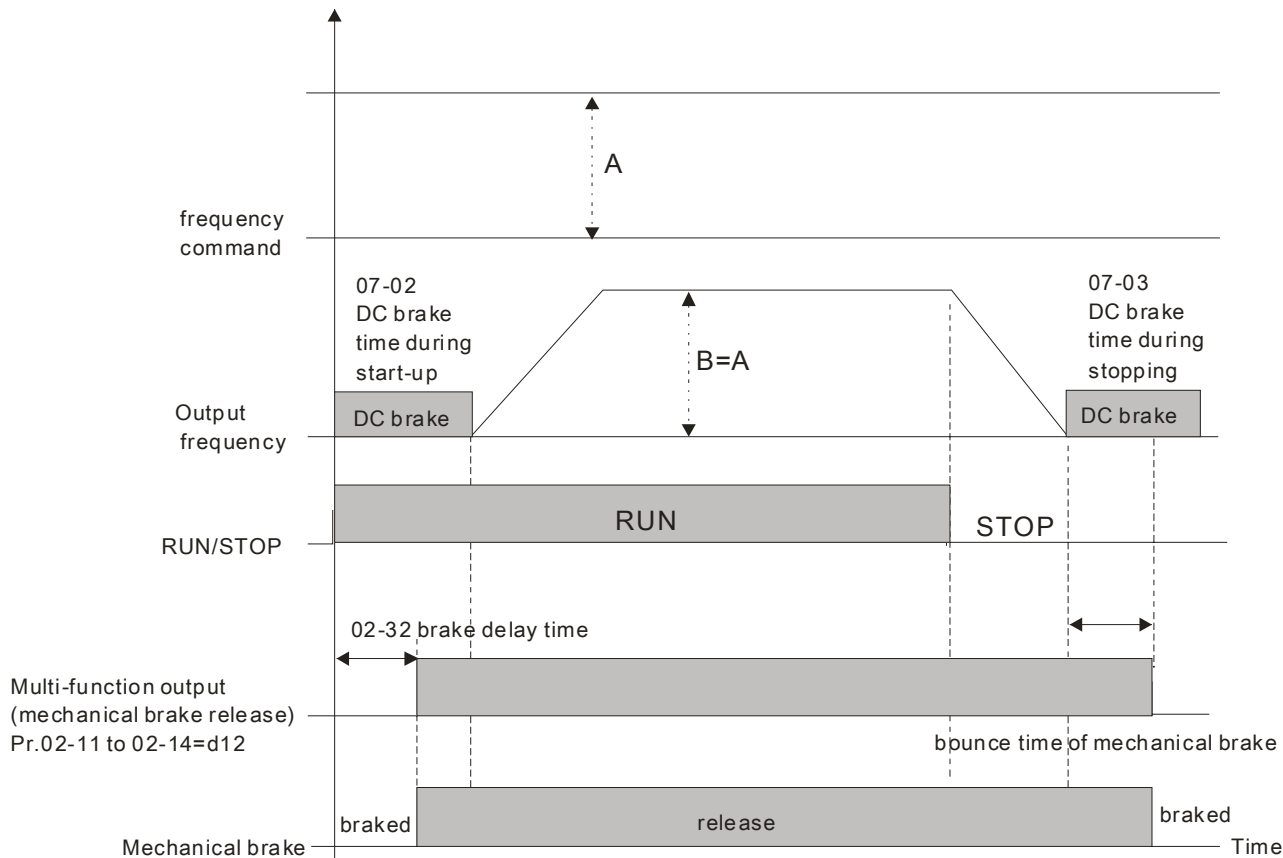

If this parameter is used without DC brake, it will be invalid. Refer to the following operation timing.

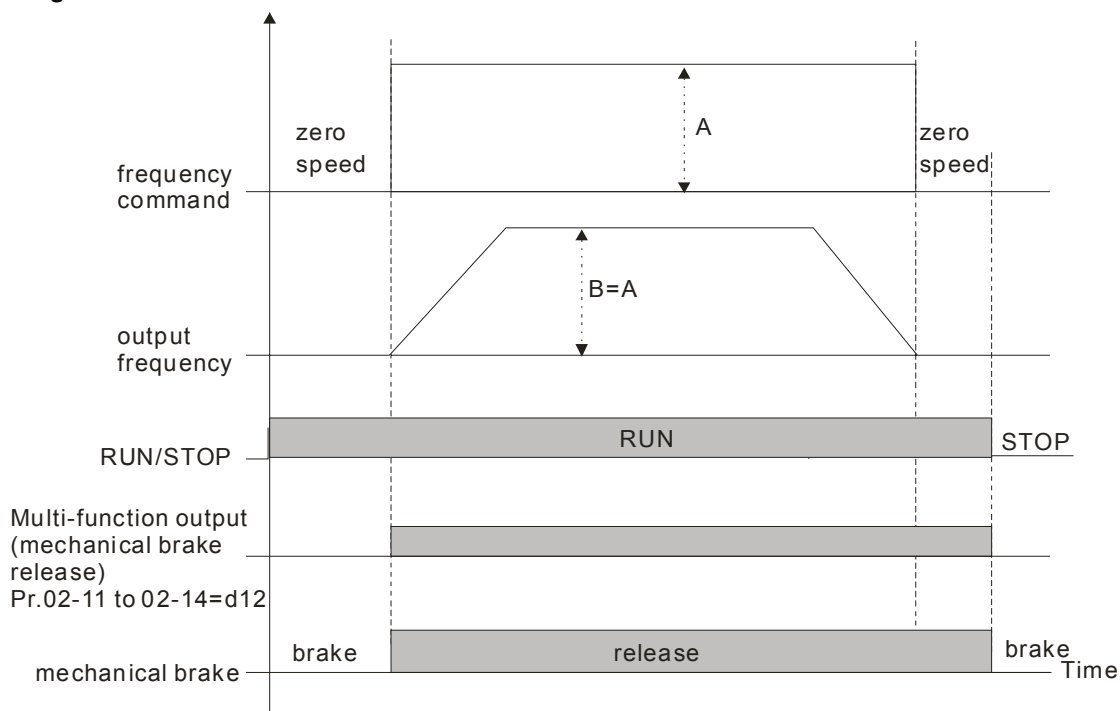

02-33 Output Current Level Setting for Multi-function Output Terminals

Factory Setting: 0

Settings 0~100%

- 📖 When output current is higher or equal to Pr.02-33, it will activate multi-function output terminal (Pr.02-13, 02-14, 02-16, and 02-17 is set to 27).
- 📖 When output current is lower or equal to Pr.02-33, it will activate multi-function output terminal (Pr.02-13, 02-14, 02-16, and 02-17 is set to 28).

🔪 **02-34** Output Boundary for Multi-function Output Terminals

Factory Setting: 0.00

Settings 0.00~599.00Hz

- 📖 When output frequency is higher or equal to Pr.02-34, it will activate the multi-function terminal (Pr.02-13, 02-14, 02-16, 02-17 is set to 29).
- 📖 When output frequency is lower or equal to Pr.02-34, it will activate the multi-function terminal (Pr.02-13, 02-14, 02-16, 02-17 is set to 30).

🔪 **02-35** External Operation Control Selection after Reset and Activate

Factory Setting: 0

Settings 0: Disable

1: Drive runs if the run command still exists after reset or re-boots.

📖 Setting 1:

Status 1: After the drive is powered on and the external terminal for RUN keeps ON, the drive will run.

Status 2: After clearing fault once a fault is detected and the external terminal for RUN keeps ON, the drive can run after pressing RESET key.

02-47 Reserved

02-48 Reserved

02-49 Reserved

02-50 Display the Status of Multi-function Input Terminal

Factory Setting: Read only

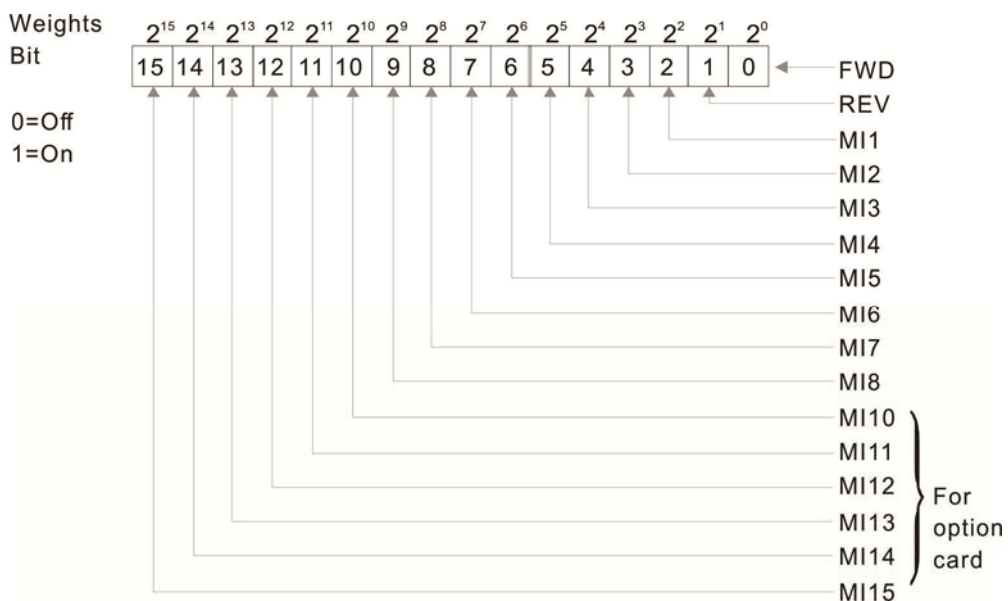

📖 For Example:

If Pr.02-50 displays 0034h (Hex), i.e. the value is 52, and 110100 (binary). It means MI1, MI3 and MI4 are active.

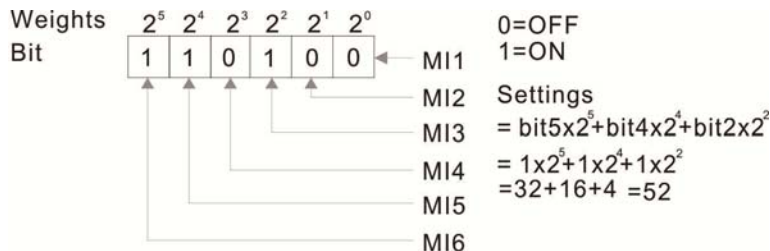

02-51 Status of Multi-function Output Terminal Factory Setting: Read only

For Example:

If Pr.02-51 displays 000Bh (Hex), i.e. the value is 11, and 1011 (binary). It means RY1, RY2 and MO1 are ON.

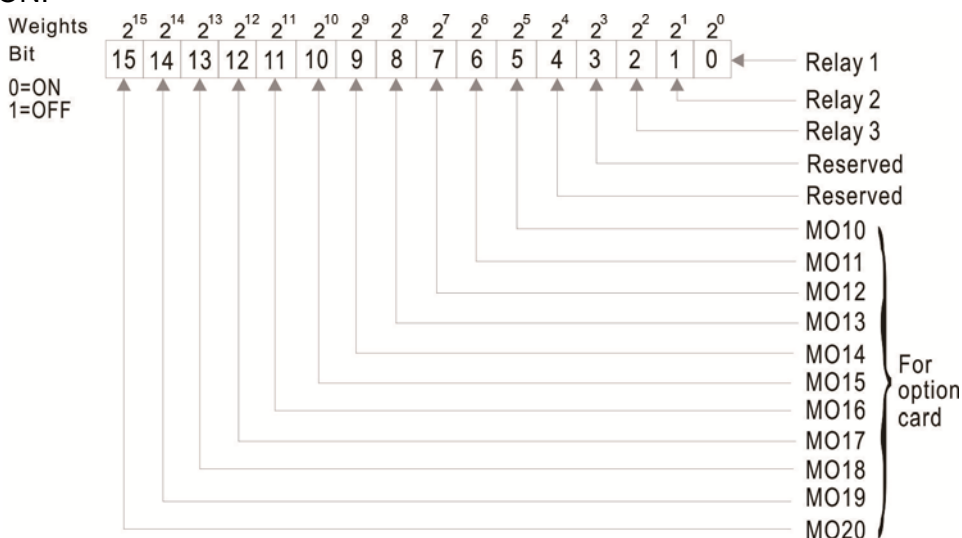

02-52 Display External Output terminal occupied by PLC Factory Setting: Read only

P.02-52 shows the external multi-function input terminal that used by PLC.

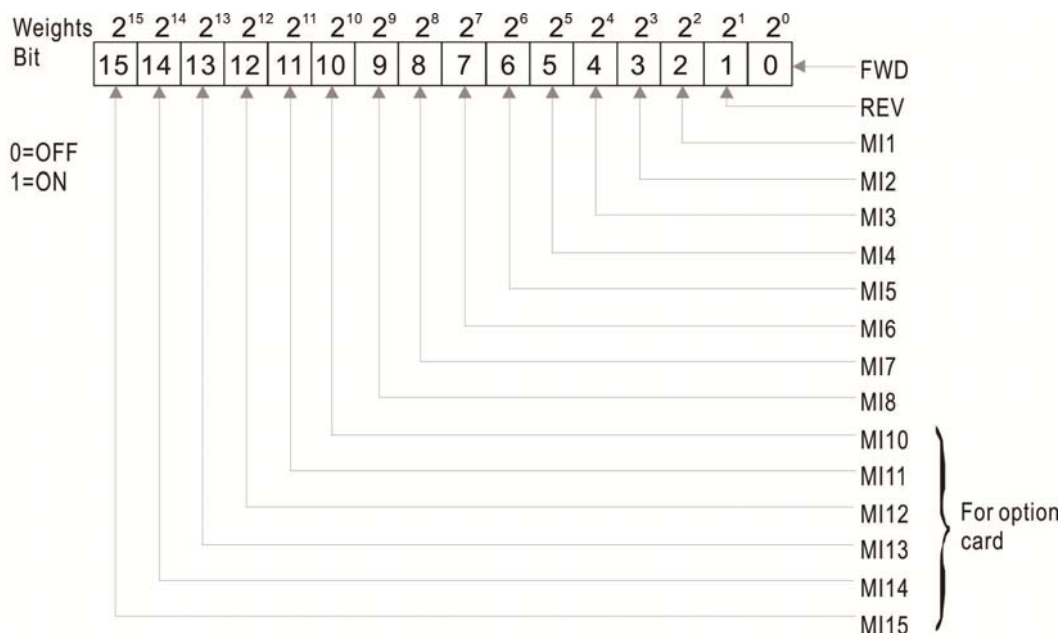

For Example:

When Pr.02-52 displays 0034h(hex) and switching to 110100 (binary), it means MI1, MI3 and MI4 are used by PLC.

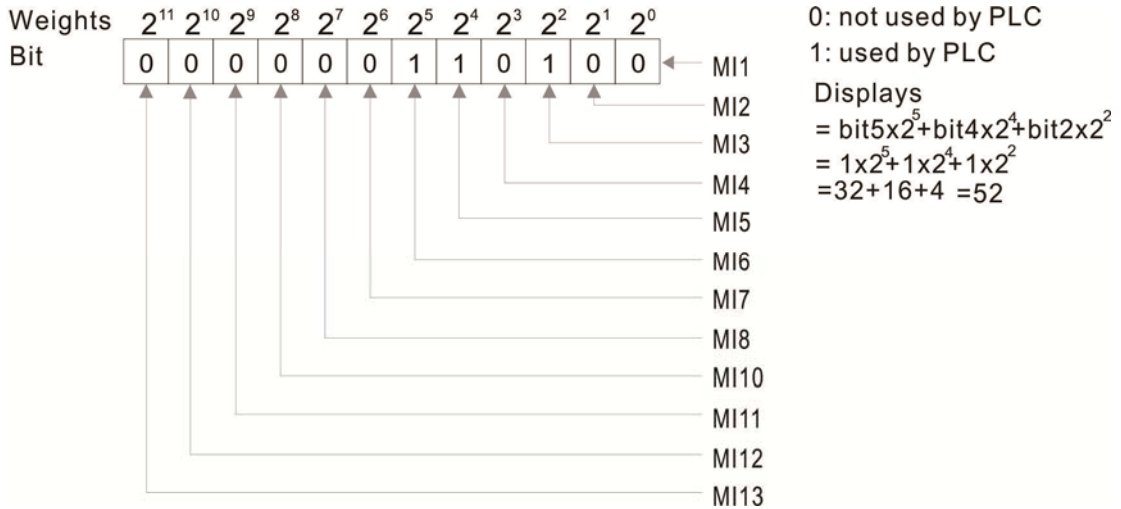

02-53 Display External Multi-function Output Terminal occupied by PLC

Factory Setting: Read only

P.02-53 shows the external multi-function output terminal that used by PLC.

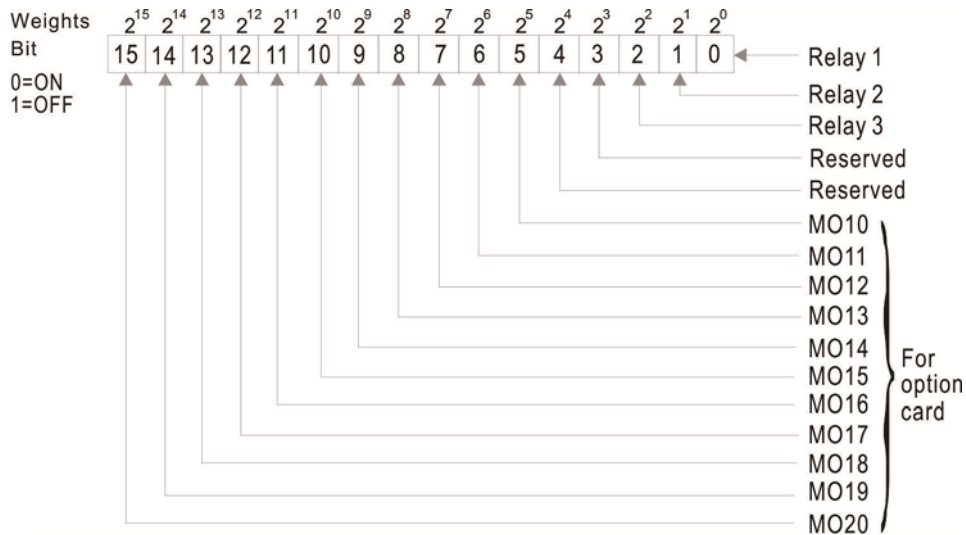

For Example:

If the value of Pr.02-53 displays 0003h (Hex), it means RY1 and RY2 are used by PLC.

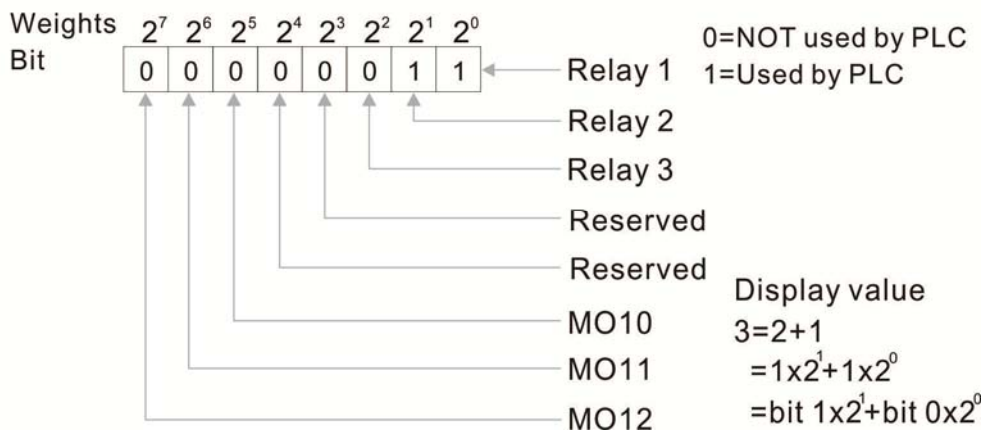

02-54 Display the Frequency Command Executed by External Terminal

Factory Setting: Read only

Settings 0.01~599.00Hz (Read only)

- When the source of frequency command comes from the external terminal, if Lv or Fault occurs at this time, the frequency command of the external terminal will be saved in this parameter.

02-55 Reserved**02-56** Reserved**02-70** IO Card Type

Factory setting: Read only

Settings Read only

0: No IO Card
1: EMC-BPS01 Card
2: No IO Card
3: No IO Card
4: EMC-D611A Card
5: EMC-D42A Card
6: EMC-R6AA Card
7: No IO Card

02-72 Output Current Level of Preheating

Factory Setting: 0

Settings 0~100%

- When a motor drive is not in operation (STOP) and is placed in a cold and humid environment, enable the preheating function to output DC current to heat up the motor drive can prevent the invasion of the humidity to the motor drive which creates condensation affecting the normal function of the motor drive.
- This parameter sets the output current level from the motor drive to the motor after enabling the preheating. The percentage of the preheating DC current is 100% to the rated current of the motor drive (Pr.05-01, Pr.05-13, Pr.05-34). When setting this parameter, increase slowly the percentage to reach the sufficient preheating temperature.

02-73 Output Current Cycle of Preheating

Factory Setting: 0

Settings 0~100%

- This parameter sets the output current cycle of preheating. 0 ~100% corresponds to 0~10 seconds. When set to 0%, there is no output current. When set to 100%, there is a continuous output. For example, when set to 50%, a cycle of preheating goes from OFF(5 seconds) to ON(5 seconds) and vice versa.
- Related Parameters of Preheating

Parameter	Description	Setting Range	Explanation
02-72	Output Current Level of Preheating	0~100% (Rated Current of the Motor) 0% No output	
02-73	Output Cycle of Preheating	0~100% (0~10sec) 0% No output 100% Continuous output	
02-01~08 02-26~31	Multi-Input Function Commands (MFI)	69 Preheating Command	Enable or Disable the Preheating
02-13~15 02-36~46	Multi-Output Function Commands (MFO)	69 Output Command of Preheating	Indication of the Preheating

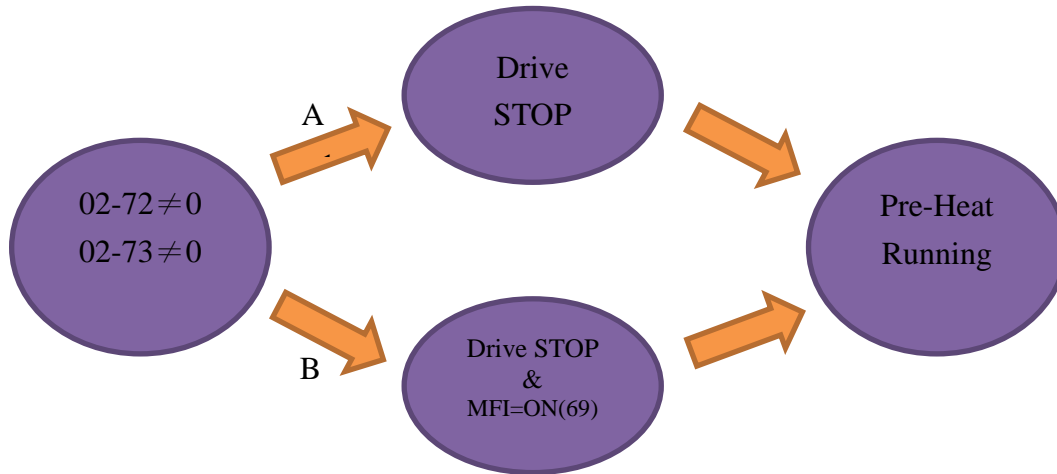

- 📖 Enable the Preheating: When Pr02-72 and Pr02-73 are NOT set to zero, the preheating is enabled.
- 📖 Preheating Function A: If Pr07-72 and Pr07-23 are set before the motor drive stops operation (STOP), the preheating will be enabled right after the motor drive stops. However if Pr07-72 and Pr07-73 are set after the motor drives stops operation, then preheating will not be enabled. Only after the motor drive stops again or restarts, the preheating will be enabled.
- 📖 Preheating Function B: When motor drive is in operation (RUN) or stops operating (STOP), set Pr02-72 and Pr02-73 between 1% ~100% and set MFI= 69 and MFI = On. The preheating will be enabled when the motor drive stops, No matter if the motor drive is in operation (RUN) or stops operating (STOP).
- 📖 Operation priority: When both the preheating function A and B are given, the function B has the priority to operate.

Sequential Diagram of the Preheating Function:

 Setting Parameters to Enable Preheating (Function A)

Set Pr02-72 and Pr02-73 not equal to zero (Diagram 50%) and stop running the motor drive, then the preheating will be enabled to output DC current. In the meantime, MFO (Output Command of Preheating) will be ON (MFO =69). Once repower on, the preheating function will be enabled right away. Besides, the sequence of preheating goes from OFF(5 seconds) to ON(5 seconds). When the motor is in operation (RUN), the preheating function will be off even it is enabled. Meanwhile, MFO is OFF (MFO =69) and the preheating will be enabled when the motor drive stops.

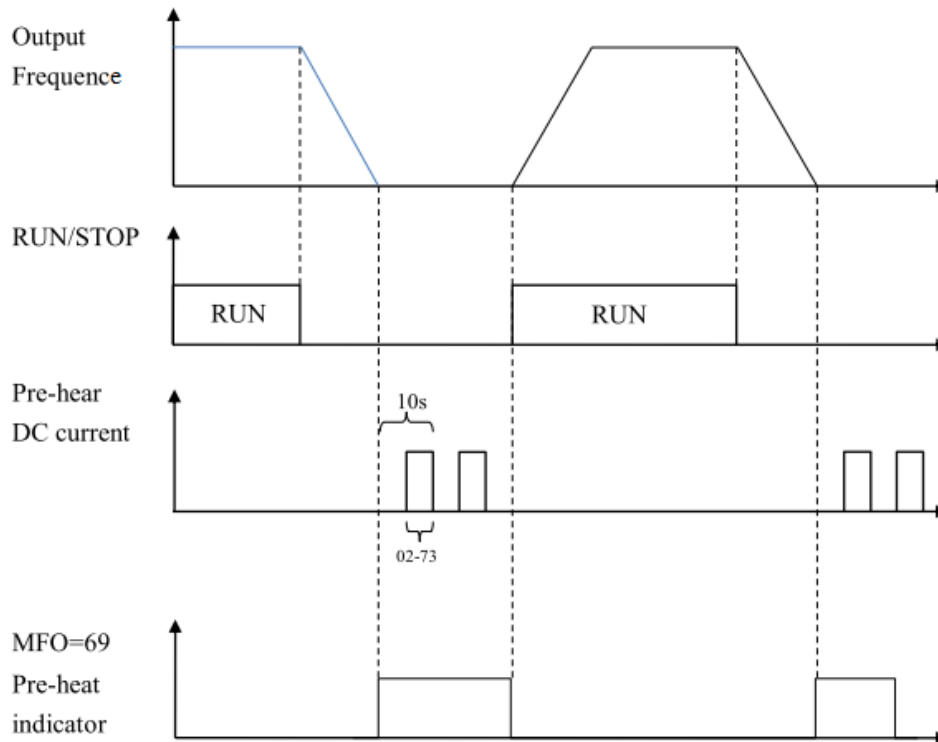

 Enable Preheating via Multi-Input Terminals (Function B)

Set Pr02-72 and Pr02-73 (Diagram 50%) not equal to zero and set MFI=69, MFI = ON, then this Function B has the priority to enable/ disable the preheating on the motor drive. In the meantime, the preheating by parameters is automatically ineffective. If, at this moment, the motor drive is already not in operation (STOP), the preheating will be enabled to output DC current and MFO (Output Command of Preheating) will be ON (MFO =69). Besides, the sequence of preheating goes from OFF(5 seconds) to ON(5 seconds). When the motor is in operation (RUN), the preheating function will be off even it is enabled. Meanwhile, MFO is OFF (MFO =69) and the preheating will be enabled when the motor drive stops.

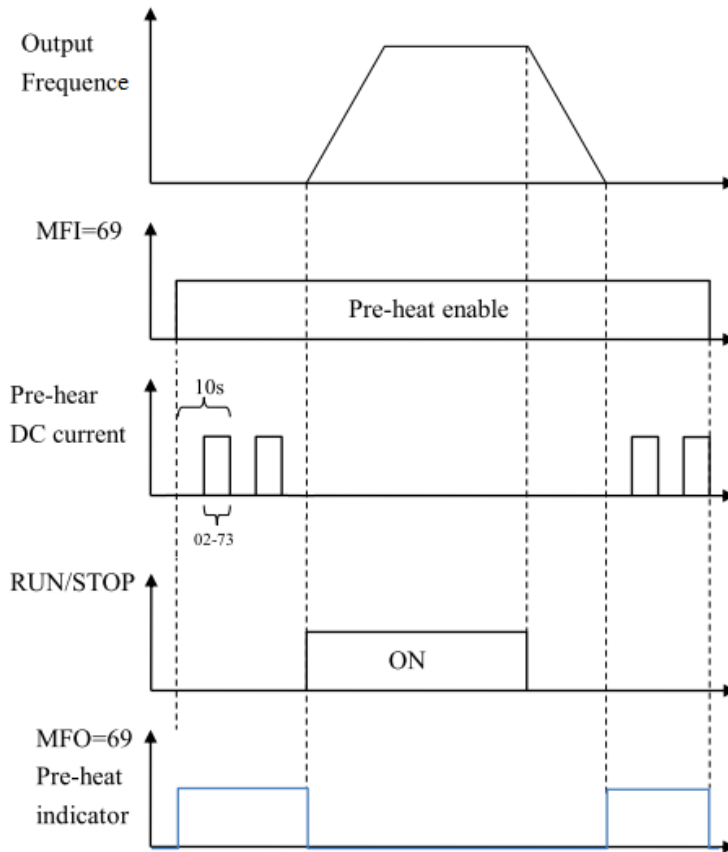

Enable DC Brake Function

DC brake and preheating are enabled at the same time. The motor drive operates in the same logic as mentioned above. The only difference is that when the motor drive is in operation (RUN) or stops operating (STOP), DC brake will be enabled first. Then when motor drive stops, preheating will be activated.

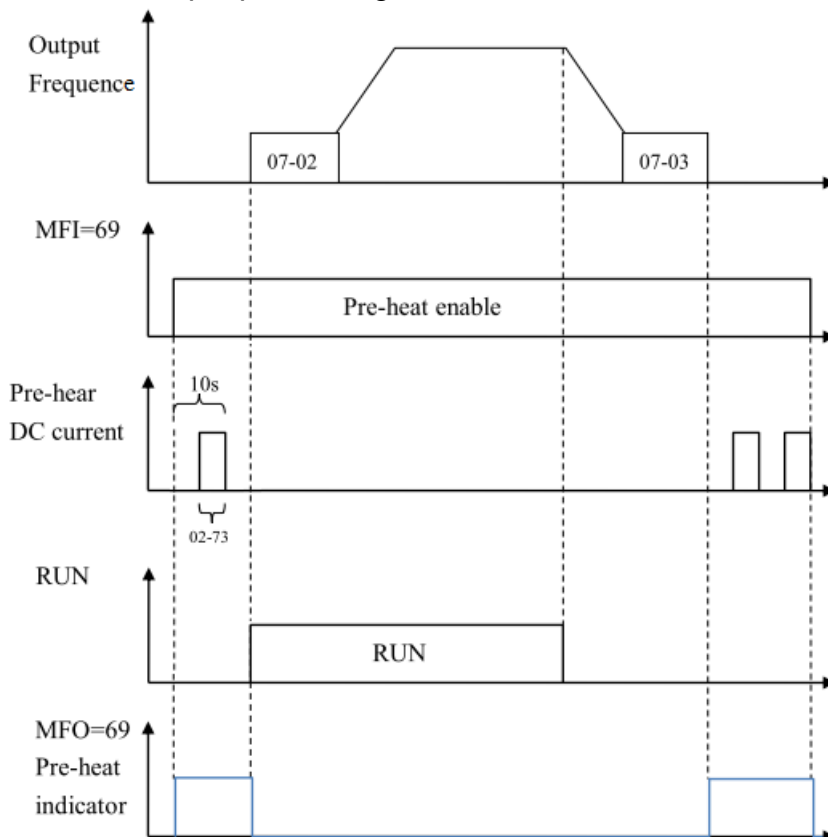





03 Analog Input/Output Parameter ✎ This parameter can be set during operation.

✎	03-00 Analog Input Selection (AVI1)	Factory Setting: 1
✎	03-01 Analog Input Selection (ACI)	Factory Setting: 0
✎	03-02 Analog Input Selection (AVI2)	Factory Setting: 0

Settings

- 0: No function
- 1: Frequency command (speed limit under torque control mode)
- 2~3: Reserved
- 4: PID target value
- 5: PID feedback signal
- 6: PTC thermistor input value
- 7~10: Reserved
- 11: PT100 thermistor input value
- 12: Reserved
- 13: PID bias value
- 14~17: Reserved

-  When use analog input as PID reference value, Pr00-20 must set 2(analog input).
Setting method 1: Pr03-00~03-02 set 1 as PID reference input
Setting method 2: Pr03-00~03-02 set 4 as PID reference input
-  When use analog input as PID compensation value, Pr08-16 must set 1(Source of PID compensation is analog input). The compensation value can be observed via Pr08-17.
-  When it is frequency command or TQC speed limit, the corresponding value for 0~±10V/4~20mA is 0 – max. output frequency(Pr.01-00)
-  When Pr.03-00~Pr.03-02 have the same setting, then the AVI will be the prioritized selection.

✎	03-03 Analog Input Bias (AVI1)	Factory Setting: 0
---	---------------------------------------	--------------------

Settings -100.0~100.0%

-  It is used to set the corresponding AVI voltage of the external analog input 0.



✎	03-04 Analog Input Bias (ACI)	Factory Setting: 0
---	--------------------------------------	--------------------

Settings -100.0~100.0%

-  It is used to set the corresponding ACI voltage of the external analog input 0.

✎	03-05 Analog Voltage Input Bias (AVI2)	Factory Setting: 0
---	---	--------------------

Settings -100.0~100.0%

-  It is used to set the corresponding AVI2 voltage of the external analog input 0.
-  The relation between external input voltage/current and setting frequency: 0~10V (4~20mA) corresponds to 0~Pr01-00 (max. operation frequency).

↗ **03-06** Reserved

↗ **03-07** Positive/negative Bias Mode (AVI1)

↗ **03-08** Positive/negative Bias Mode (ACI)

↗ **03-09** Positive/negative Bias Mode (AVI2)

Factory Setting: 0

- Settings
- 0: Zero bias
 - 1: Lower than or equal to bias
 - 2: Greater than or equal to bias
 - 3: The absolute value of the bias voltage while serving as the center
 - 4: Serve bias as the center

📖 In a noisy environment, it is advantageous to use negative bias to provide a noise margin. It is recommended NOT to use less than 1V to set the operation frequency.

↗ **03-10** Analog Frequency Command for Reverse Run

Factory Setting: 0

- Settings
- 0: Negative frequency is not valid. Forward and reverse run is controlled by digital keypad or external terminal.
 - 1: Negative frequency is valid. Positive frequency = forward run; negative frequency = reverse run. Run direction can not be switched by digital keypad or the external terminal control.

📖 Parameter 03-10 is used to enable reverse run command when a negative frequency (negative bias and gain) is input to AVI or ACI analog signal input (except AUI).

📖 Condition for negative frequency (reverse)

1. Pr03-10=1
2. Bias mode=Serve bias as center
3. Corresponded analog input gain < 0(negative), make input frequency be negative.

In using addition function of analog input (Pr03-18=1), when analog signal is negative after adding, this parameter can be set for allowing reverse or not. The result after adding will be restricted by "Condition for negative frequency (reverse)"

In the diagram below: Black line: Curve with no bias. Gray line: curve with bias

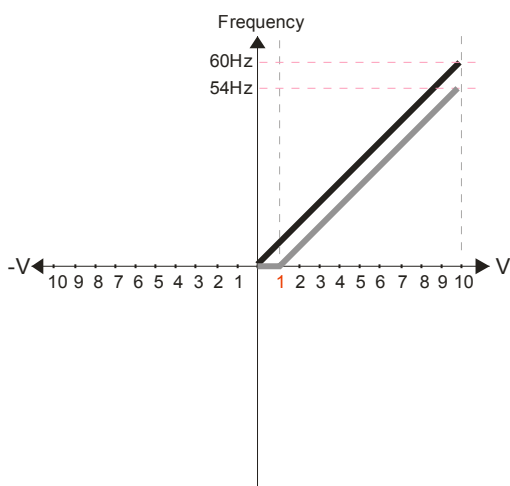

Pr.03-03=10%

Pr.03-07~03-09 (Positive/Negative Bias Mode)

0: No bias

1: Lower than or equal to bias

2: Greater than or equal to bias

3: The absolute value of the bias voltage while serving as the center

4: Serve bias as the center

Pr.03-10 (Analog Frequency Command for Reverse Run)

0: Negative frequency is not valid.

Forward and reverse run is controlled by digital keypad or external terminal.

1: Negative frequency is valid. Positive frequency = forward run; negative frequency = reverse run. Direction can not be switched by digital keypad or external terminal control.

Pr.03-11 Analog Input Gain (AVI)= 100%

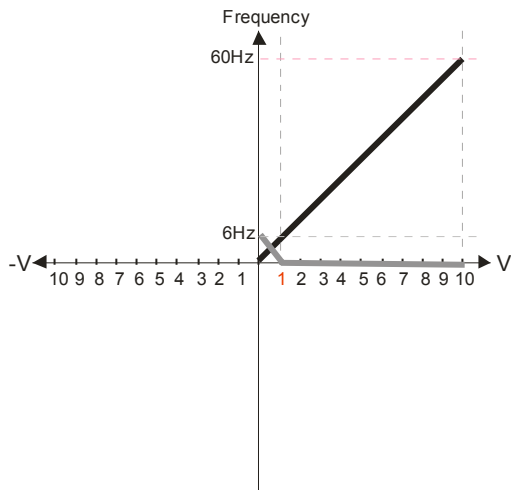

Pr.03-03=10%

Pr.03-07~03-09 (Positive/Negative Bias Mode)

- 0: No bias
- 1: Lower than or equal to bias
- 2: Greater than or equal to bias
- 3: The absolute value of the bias voltage while serving as the center
- 4: Serve bias as the center

Pr.03-10 (Analog Frequency Command for Reverse Run)

- 0: Negative frequency is not valid. Forward and reverse run is controlled by digital keypad or external terminal.
- 1: Negative frequency is valid. Positive frequency = forward run; negative frequency = reverse run. Direction can not be switched by digital keypad or external terminal control.

Pr.03-11 Analog Input Gain (AVI)=100%

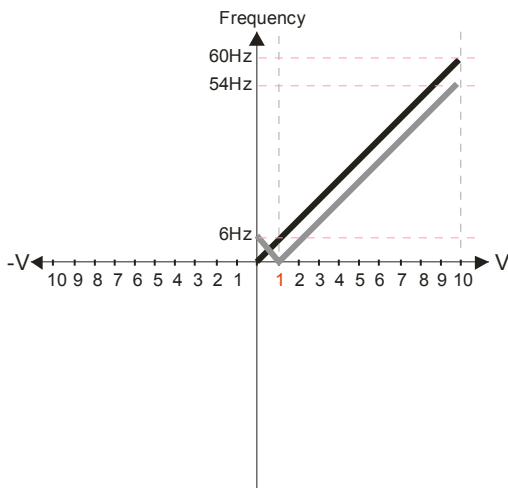

Pr.03-03=10%

Pr.03-07~03-09 (Positive/Negative Bias Mode)

- 0: No bias
- 1: Lower than or equal to bias
- 2: Greater than or equal to bias
- 3: The absolute value of the bias voltage while serving as the center
- 4: Serve bias as the center

Pr.03-10 (Analog Frequency Command for Reverse Run)

- 0: Negative frequency is not valid. Forward and reverse run is controlled by digital keypad or external terminal.
- 1: Negative frequency is valid. Positive frequency = forward run; negative frequency = reverse run. Direction can not be switched by digital keypad or external terminal control.

Pr.03-11 Analog Input Gain (AVI) = 100%

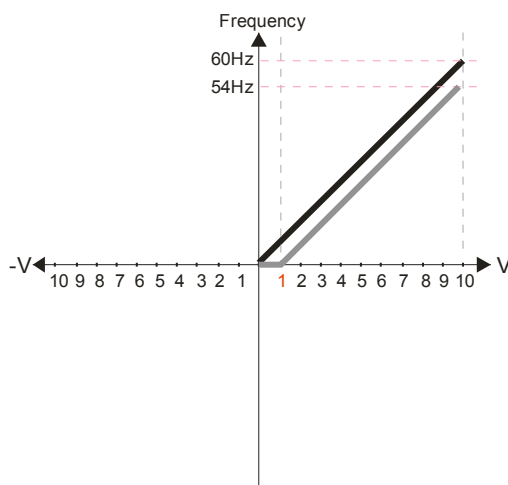

Pr.03-03=10%

Pr.03-07~03-09 (Positive/Negative Bias Mode)

- 0: No bias
- 1: Lower than or equal to bias
- 2: Greater than or equal to bias
- 3: The absolute value of the bias voltage while serving as the center
- 4: Serve bias as the center

Pr.03-10 (Analog Frequency Command for Reverse Run)

- 0: Negative frequency is not valid. Forward and reverse run is controlled by digital keypad or external terminal.
- 1: Negative frequency is valid. Positive frequency = forward run; negative frequency = reverse run. Direction can not be switched by digital keypad or external terminal control.

Pr.03-11 Analog Input Gain (AVI) = 100%

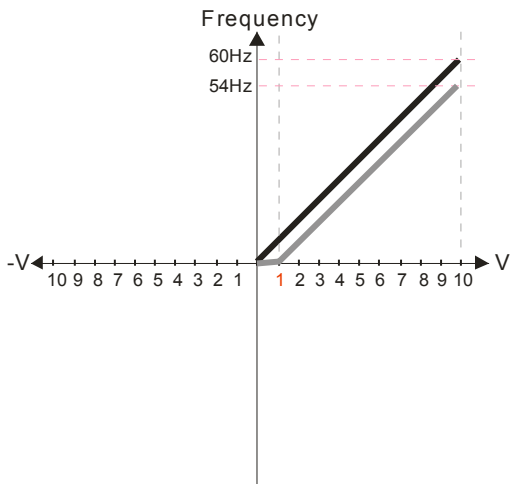

- Pr.03-03=10%
- Pr.03-07~03-09 (Positive/Negative Bias Mode)
 - 0: No bias
 - 1: Lower than or equal to bias
 - 2: Greater than or equal to bias
 - 3: The absolute value of the bias voltage while serving as the center
 - 4: Serve bias as the center

- Pr.03-10 (Analog Frequency Command for Reverse Run)
 - 0: Negative frequency is not valid. Forward and reverse run is controlled by digital keypad or external terminal.
 - 1: Negative frequency is valid. Positive frequency = forward run; negative frequency = reverse run. Direction can not be switched by digital keypad or external terminal control.

Pr.03-11 Analog Input Gain (AVI)= 100%

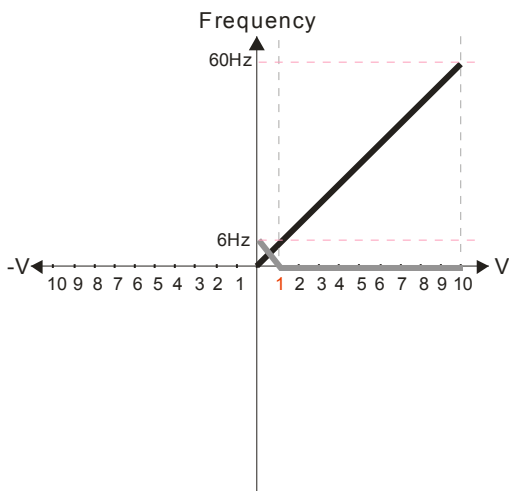

- Pr.03-03=10%
- Pr.03-07~03-09 (Positive/Negative Bias Mode)
 - 0: No bias
 - 1: Lower than or equal to bias
 - 2: Greater than or equal to bias
 - 3: The absolute value of the bias voltage while serving as the center
 - 4: Serve bias as the center

- Pr.03-10 (Analog Frequency Command for Reverse Run)
 - 0: Negative frequency is not valid. Forward and reverse run is controlled by digital keypad or external terminal.
 - 1: Negative frequency is valid. Positive frequency = forward run; negative frequency = reverse run. Direction can not be switched by digital keypad or external terminal control.

Pr.03-11 Analog Input Gain (AVI)= 100%

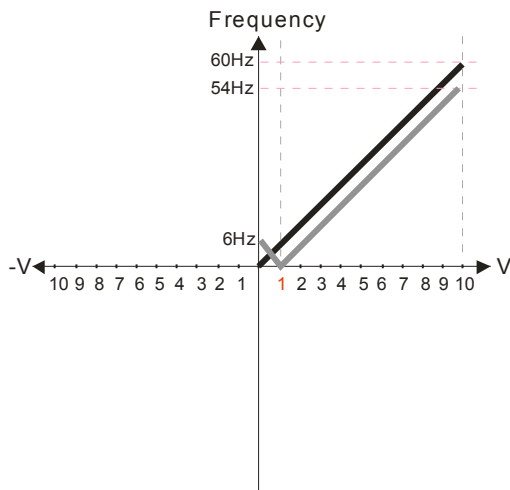

- Pr.03-03=10%
- Pr.03-07~03-09 (Positive/Negative Bias Mode)
 - 0: No bias
 - 1: Lower than or equal to bias
 - 2: Greater than or equal to bias
 - 3: The absolute value of the bias voltage while serving as the center
 - 4: Serve bias as the center

- Pr.03-10 (Analog Frequency Command for Reverse Run)
 - 0: Negative frequency is not valid. Forward and reverse run is controlled by digital keypad or external terminal.
 - 1: Negative frequency is valid. Positive frequency = forward run; negative frequency = reverse run. Direction can not be switched by digital keypad or external terminal control.

Pr.03-11 Analog Input Gain (AVI) = 100%

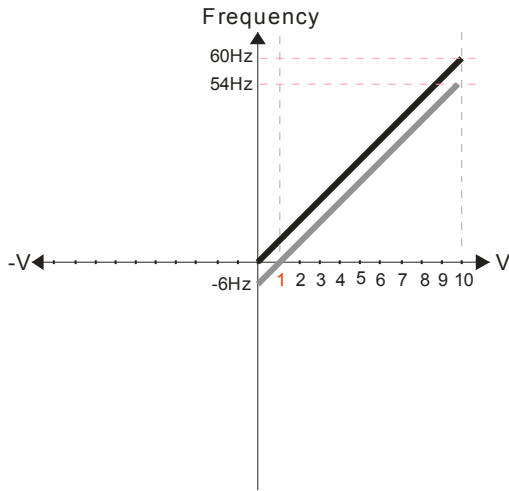

Pr.03-03=10%

Pr.03-07~03-09 (Positive/Negative Bias Mode)

- 0: No bias
- 1: Lower than or equal to bias
- 2: Greater than or equal to bias
- 3: The absolute value of the bias voltage while serving as the center
- 4: Serve bias as the center

Pr.03-10 (Analog Frequency Command for Reverse Run)

- 0: Negative frequency is not valid. Forward and reverse run is controlled by digital keypad or external terminal.
- 1: Negative frequency is valid. Positive frequency = forward run; negative frequency = reverse run. Direction can not be switched by digital keypad or external terminal control.

Pr.03-11 Analog Input Gain (AVI) = 100%

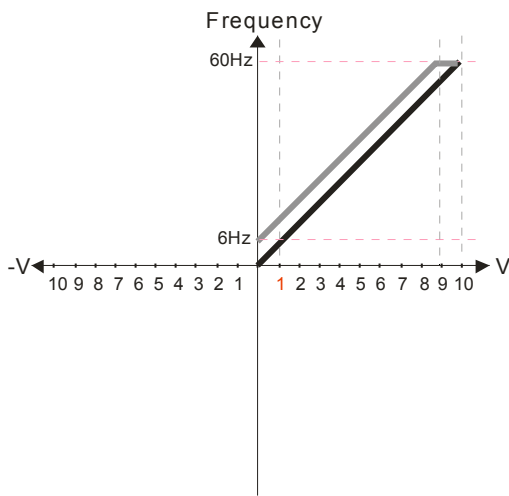

Pr.03-03=-10%

Pr.03-07~03-09 (Positive/Negative Bias Mode)

- 0: No bias
- 1: Lower than or equal to bias
- 2: Greater than or equal to bias
- 3: The absolute value of the bias voltage while serving as the center
- 4: Serve bias as the center

Pr.03-10 (Analog Frequency Command for Reverse Run)

- 0: Negative frequency is not valid. Forward and reverse run is controlled by digital keypad or external terminal.
- 1: Negative frequency is valid. Positive frequency = forward run; negative frequency = reverse run. Direction can not be switched by digital keypad or external terminal control.

Pr.03-11 Analog Input Gain (AVI)= 100%

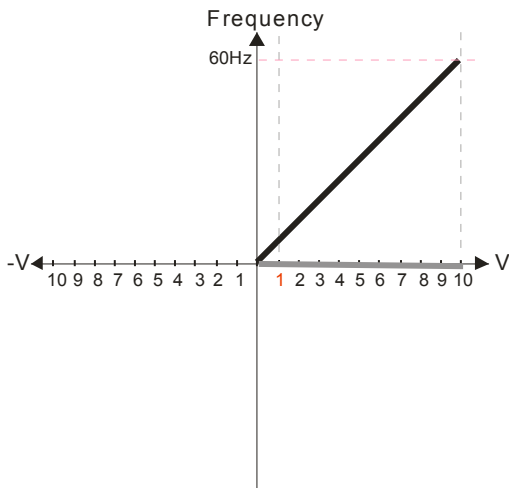

Pr.03-03=-10%

Pr.03-07~03-09 (Positive/Negative Bias Mode)

- 0: No bias
- 1: Lower than or equal to bias
- 2: Greater than or equal to bias
- 3: The absolute value of the bias voltage while serving as the center
- 4: Serve bias as the center

Pr.03-10 (Analog Frequency Command for Reverse Run)

- 0: Negative frequency is not valid. Forward and reverse run is controlled by digital keypad or external terminal.
- 1: Negative frequency is valid. Positive frequency = forward run; negative frequency = reverse run. Direction can not be switched by digital keypad or external terminal control.

Pr.03-11 Analog Input Gain (AVI)= 100%

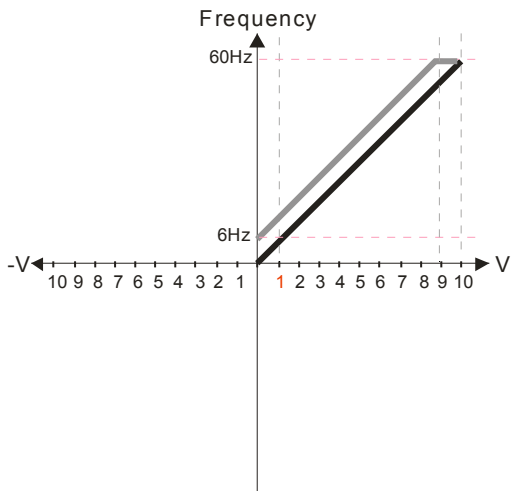

Pr.03-03=-10%
 Pr.03-07~03-09 (Positive/Negative Bias Mode)
 0: No bias
 1: Lower than or equal to bias
 2: Greater than or equal to bias
 3: The absolute value of the bias voltage while serving as the center
 4: Serve bias as the center

Pr.03-10 (Analog Frequency Command for Reverse Run)
 0: Negative frequency is not valid. Forward and reverse run is controlled by digital keypad or external terminal.
 1: Negative frequency is valid. Positive frequency = forward run; negative frequency = reverse run. Direction can not be switched by digital keypad or external terminal control.

Pr.03-11 Analog Input Gain (AVI) = 100%

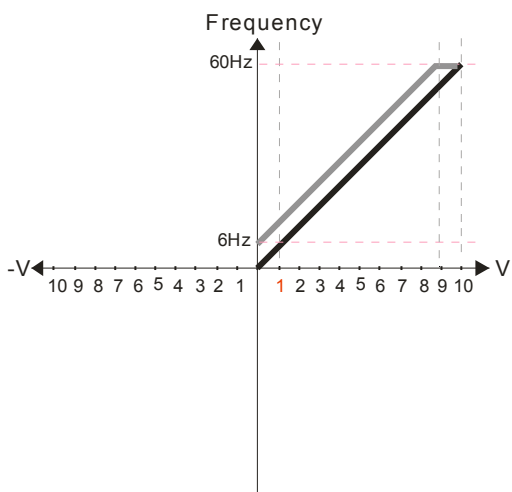

Pr.03-03=-10%
 Pr.03-07~03-09 (Positive/Negative Bias Mode)
 0: No bias
 1: Lower than or equal to bias
 2: Greater than or equal to bias
 3: The absolute value of the bias voltage while serving as the center
 4: Serve bias as the center

Pr.03-10 (Analog Frequency Command for Reverse Run)
 0: Negative frequency is not valid. Forward and reverse run is controlled by digital keypad or external terminal.
 1: Negative frequency is valid. Positive frequency = forward run; negative frequency = reverse run. Direction can not be switched by digital keypad or external terminal control.

Pr.03-11 Analog Input Gain (AVI) = 100%

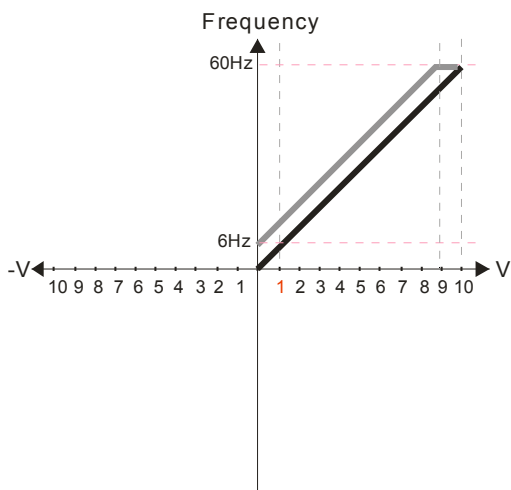

Pr.03-03=-10%
 Pr.03-07~03-09 (Positive/Negative Bias Mode)
 0: No bias
 1: Lower than or equal to bias
 2: Greater than or equal to bias
 3: The absolute value of the bias voltage while serving as the center
 4: Serve bias as the center

Pr.03-10 (Analog Frequency Command for Reverse Run)
 0: Negative frequency is not valid. Forward and reverse run is controlled by digital keypad or external terminal.
 1: Negative frequency is valid. Positive frequency = forward run; negative frequency = reverse run. Direction can not be switched by digital keypad or external terminal control.

Pr.03-11 Analog Input Gain (AVI)= 100%

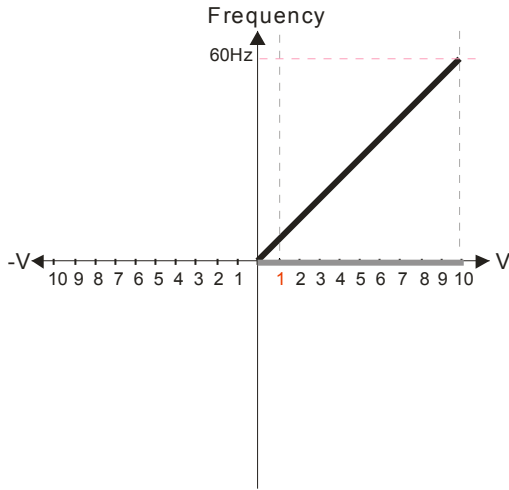

Pr.03-03=-10%

Pr.03-07~03-09 (Positive/Negative Bias Mode)

- 0: No bias
- 1: Lower than or equal to bias
- 2: Greater than or equal to bias
- 3: The absolute value of the bias voltage while serving as the center
- 4: Serve bias as the center

Pr.03-10 (Analog Frequency Command for Reverse Run)

- 0: Negative frequency is not valid. Forward and reverse run is controlled by digital keypad or external terminal.
- 1: Negative frequency is valid. Positive frequency = forward run; negative frequency = reverse run. Direction can not be switched by digital keypad or external terminal control.

Pr.03-11 Analog Input Gain (AVI)= 100%

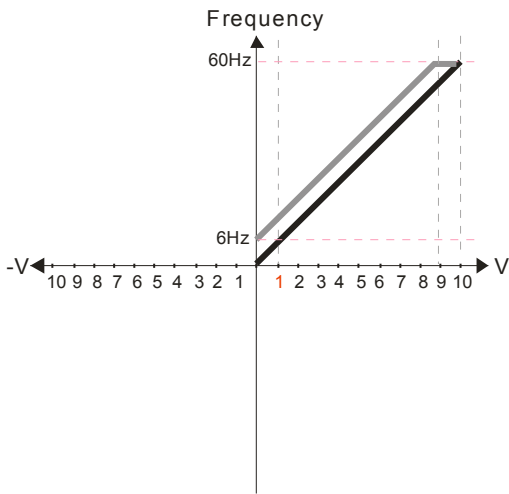

Pr.03-03=-10%

Pr.03-07~03-09 (Positive/Negative Bias Mode)

- 0: No bias
- 1: Lower than or equal to bias
- 2: Greater than or equal to bias
- 3: The absolute value of the bias voltage while serving as the center
- 4: Serve bias as the center

Pr.03-10 (Analog Frequency Command for Reverse Run)

- 0: Negative frequency is not valid. Forward and reverse run is controlled by digital keypad or external terminal.
- 1: Negative frequency is valid. Positive frequency = forward run; negative frequency = reverse run. Direction can not be switched by digital keypad or external terminal control.

Pr.03-11 Analog Input Gain (AVI) = 100%

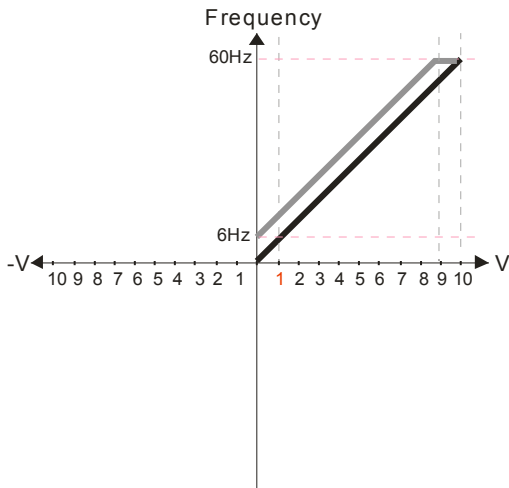

Pr.03-03=-10%

Pr.03-07~03-09 (Positive/Negative Bias Mode)

- 0: No bias
- 1: Lower than or equal to bias
- 2: Greater than or equal to bias
- 3: The absolute value of the bias voltage while serving as the center
- 4: Serve bias as the center

Pr.03-10 (Analog Frequency Command for Reverse Run)

- 0: Negative frequency is not valid. Forward and reverse run is controlled by digital keypad or external terminal.
- 1: Negative frequency is valid. Positive frequency = forward run; negative frequency = reverse run. Direction can not be switched by digital keypad or external terminal control.

Pr.03-11 Analog Input Gain (AVI) = 100%

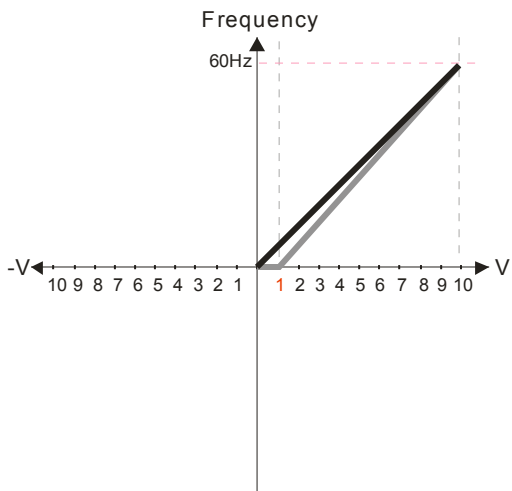

Pr.03-03=-10%

Pr.03-07~03-09 (Positive/Negative Bias Mode)

- 0: No bias
- 1: Lower than or equal to bias
- 2: Greater than or equal to bias
- 3: The absolute value of the bias voltage while serving as the center
- 4: Serve bias as the center

Pr.03-10 (Analog Frequency Command for Reverse Run)

- 0: Negative frequency is not valid. Forward and reverse run is controlled by digital keypad or external terminal.
- 1: Negative frequency is valid. Positive frequency = forward run; negative frequency = reverse run. Direction can not be switched by digital keypad or external terminal control.

Pr.03-11 Analog Input Gain (AVI)= 111.1%
10/9=111.1%

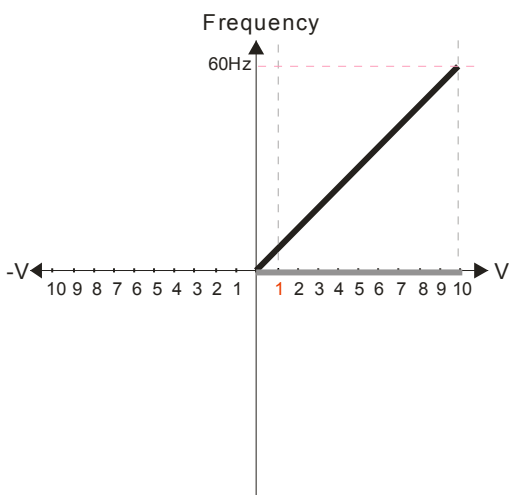

Pr.03-03=10%

Pr.03-07~03-09 (Positive/Negative Bias Mode)

- 0: No bias
- 1: Lower than or equal to bias
- 2: Greater than or equal to bias
- 3: The absolute value of the bias voltage while serving as the center
- 4: Serve bias as the center

Pr.03-10 (Analog Frequency Command for Reverse Run)

- 0: Negative frequency is not valid. Forward and reverse run is controlled by digital keypad or external terminal.
- 1: Negative frequency is valid. Positive frequency = forward run; negative frequency = reverse run. Direction can not be switched by digital keypad or external terminal control.

Pr.03-11 Analog Input Gain (AVI)=111.1%
10/9 =111.1%

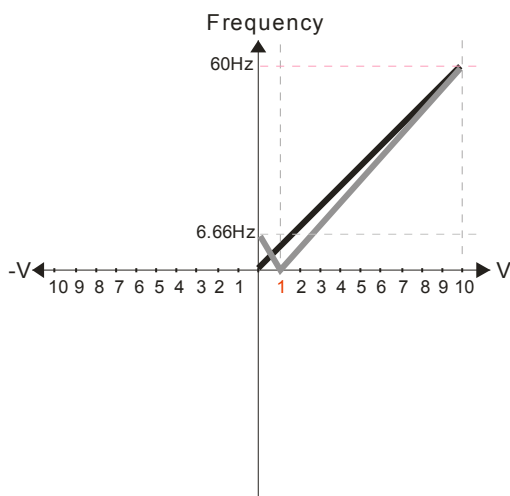

Pr.03-03=10%

Pr.03-07~03-09 (Positive/Negative Bias Mode)

- 0: No bias
- 1: Lower than or equal to bias
- 2: Greater than or equal to bias
- 3: The absolute value of the bias voltage while serving as the center
- 4: Serve bias as the center

Pr.03-10 (Analog Frequency Command for Reverse Run)

- 0: Negative frequency is not valid. Forward and reverse run is controlled by digital keypad or external terminal.
- 1: Negative frequency is valid. Positive frequency = forward run; negative frequency = reverse run. Direction can not be switched by digital keypad or external terminal control.

Pr.03-11 Analog Input Gain (AVI) = 111.1%
10/9 =111.1%

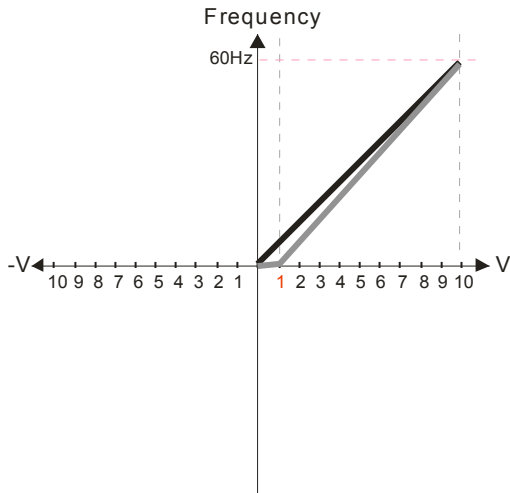

Pr.03-03=10%

Pr.03-07~03-09 (Positive/Negative Bias Mode)

- 0: No bias
- 1: Lower than or equal to bias
- 2: Greater than or equal to bias
- 3: The absolute value of the bias voltage while serving as the center
- 4: Serve bias as the center

Pr.03-10 (Analog Frequency Command for Reverse Run)

- 0: Negative frequency is not valid. Forward and reverse run is controlled by digital keypad or external terminal.
- 1: Negative frequency is valid. Positive frequency = forward run; negative frequency = reverse run. Direction can not be switched by digital keypad or external terminal control.

Pr.03-11 Analog Input Gain (AVI) = 111.1%
10/9 = 111.1%

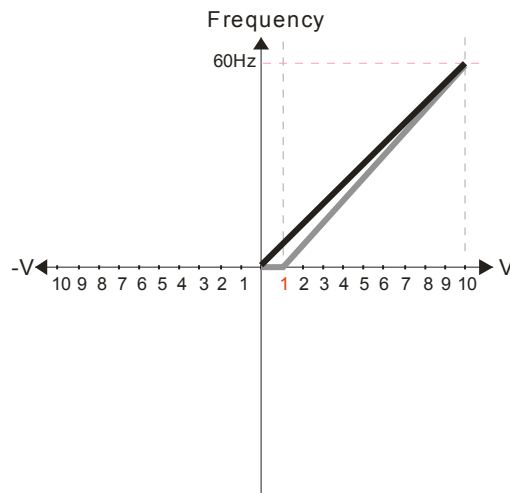

Pr.03-03=10%

Pr.03-07~03-09 (Positive/Negative Bias Mode)

- 0: No bias
- 1: Lower than or equal to bias
- 2: Greater than or equal to bias
- 3: The absolute value of the bias voltage while serving as the center
- 4: Serve bias as the center

Pr.03-10 (Analog Frequency Command for Reverse Run)

- 0: Negative frequency is not valid. Forward and reverse run is controlled by digital keypad or external terminal.
- 1: Negative frequency is valid. Positive frequency = forward run; negative frequency = reverse run. Direction can not be switched by digital keypad or external terminal control.

Pr03-11 Analog Input Gain (AVI) = 111.1%
10/9 = 111.1%

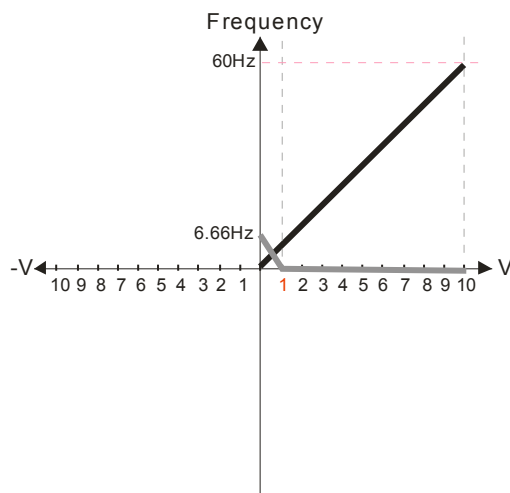

Pr.03-03=10%

Pr.03-07~03-09 (Positive/Negative Bias Mode)

- 0: No bias
- 1: Lower than or equal to bias
- 2: Greater than or equal to bias
- 3: The absolute value of the bias voltage while serving as the center
- 4: Serve bias as the center

Pr.03-10 (Analog Frequency Command for Reverse Run)

- 0: Negative frequency is not valid. Forward and reverse run is controlled by digital keypad or external terminal.
- 1: Negative frequency is valid. Positive frequency = forward run; negative frequency = reverse run. Direction can not be switched by digital keypad or external terminal control.

Pr03-11 Analog Input Gain (AVI) = 111.1%
10/9 = 111.1%

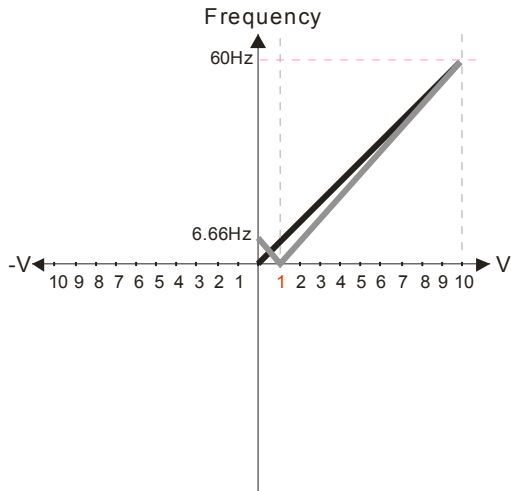

Pr.03-03=10%

Pr.03-07~03-09 (Positive/Negative Bias Mode)

- 0: No bias
- 1: Lower than or equal to bias
- 2: Greater than or equal to bias
- 3: The absolute value of the bias voltage while serving as the center
- 4: Serve bias as the center

Pr.03-10 (Analog Frequency Command for Reverse Run)

- 0: Negative frequency is not valid. Forward and reverse run is controlled by digital keypad or external terminal.
- 1: Negative frequency is valid. Positive frequency = forward run; negative frequency = reverse run. Direction can not be switched by digital keypad or external terminal control.

Pr03-11 Analog Input Gain (AVI) = 111.1%
 $10/9 = 111.1\%$

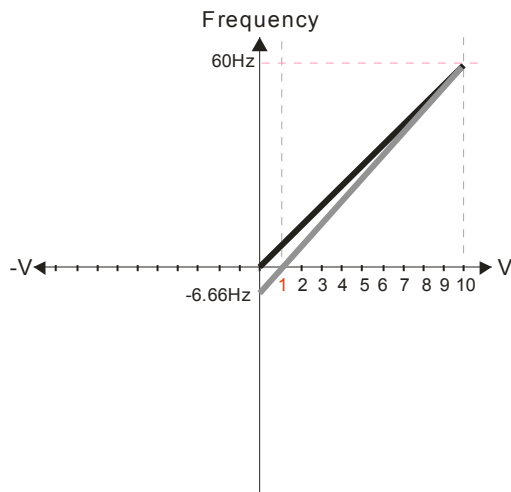

Pr.03-03=10%

Pr.03-07~03-09 (Positive/Negative Bias Mode)

- 0: No bias
- 1: Lower than or equal to bias
- 2: Greater than or equal to bias
- 3: The absolute value of the bias voltage while serving as the center
- 4: Serve bias as the center

Pr.03-10 (Analog Frequency Command for Reverse Run)

- 0: Negative frequency is not valid. Forward and reverse run is controlled by digital keypad or external terminal.
- 1: Negative frequency is valid. Positive frequency = forward run; negative frequency = reverse run. Direction can not be switched by digital keypad or external terminal control.

Pr03-11 Analog Input Gain (AVI) = 100%
 $10/9 = 111.1\%$

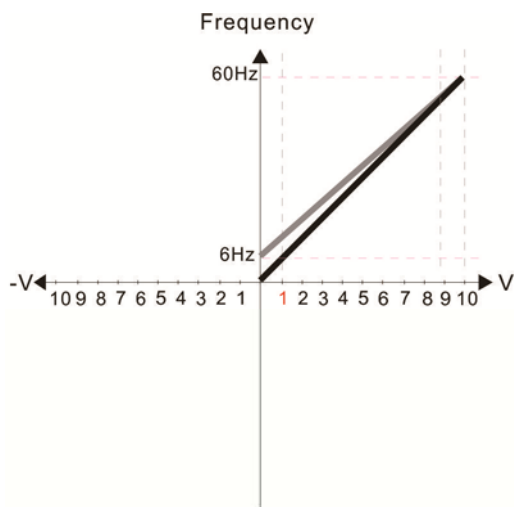

Pr.03-07~03-09 (Positive/Negative Bias Mode)

- 0: No bias
- 1: Lower than or equal to bias
- 2: Greater than or equal to bias
- 3: The absolute value of the bias voltage while serving as the center
- 4: Serve bias as the center

Pr.03-10 (Analog Frequency Command for Reverse Run)

- 0: Negative frequency is not valid. Forward and reverse run is controlled by digital keypad or external terminal.
- 1: Negative frequency is valid. Positive frequency = forward run; negative frequency = reverse run. Direction can not be switched by digital keypad or external terminal control.

Calculate the bias:

$$\frac{60-6\text{Hz}}{10\text{V}} = \frac{6-0\text{Hz}}{(0-XV)} \quad XV = \frac{100}{-9} = -1.11\text{V} \quad \therefore 03-03 = \frac{-1.11}{10} \times 100\% = -11.1\%$$

Calculate the gain: $03-11 = \frac{10\text{V}}{11.1\text{V}} \times 100\% = 90.0\%$

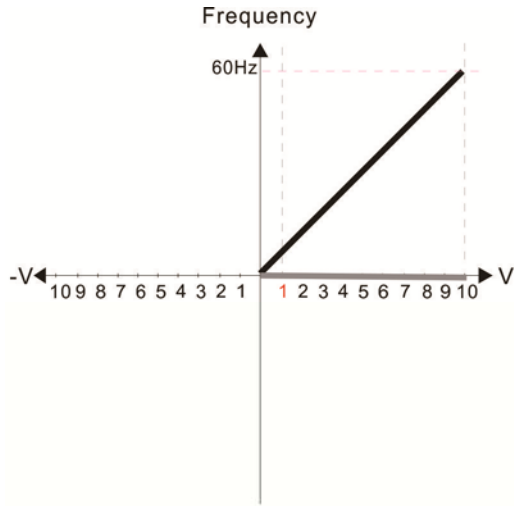

Pr.03-07~03-09 (Positive/Negative Bias Mode)

- 0: No bias
- 1: Lower than or equal to bias
- 2: Greater than or equal to bias
- 3: The absolute value of the bias voltage while serving as the center
- 4: Serve bias as the center

Pr.03-10 (Analog Frequency Command for Reverse Run)

- 0: Negative frequency is not valid. Forward and reverse run is controlled by digital keypad or external terminal.
- 1: Negative frequency is valid. Positive frequency = forward run; negative frequency = reverse run. Direction can not be switched by digital keypad or external terminal control.

Calculate the bias:

$$\frac{60-6\text{Hz}}{10\text{V}} = \frac{6-0\text{Hz}}{(0-XV)} \quad XV = \frac{100}{-9} = -1.11\text{V} \quad \therefore 03-03 = \frac{-1.11}{10} \times 100\% = -11.1\%$$

Calculate the gain: $03-11 = \frac{10\text{V}}{11.1\text{V}} \times 100\% = 90.0\%$

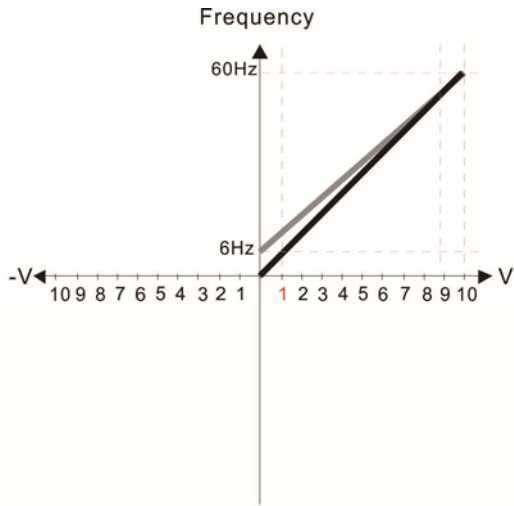

Pr.03-07~03-09 (Positive/Negative Bias Mode)

- 0: No bias
- 1: Lower than or equal to bias
- 2: Greater than or equal to bias
- 3: The absolute value of the bias voltage while serving as the center
- 4: Serve bias as the center

Pr.03-10 (Analog Frequency Command for Reverse Run)

- 0: Negative frequency is not valid. Forward and reverse run is controlled by digital keypad or external terminal.
- 1: Negative frequency is valid. Positive frequency = forward run; negative frequency = reverse run. Direction can not be switched by digital keypad or external terminal control.

Calculate the bias:

$$\frac{60-6\text{Hz}}{10\text{V}} = \frac{6-0\text{Hz}}{(0-XV)} \quad XV = \frac{100}{-9} = -1.11\text{V} \quad \therefore 03-03 = \frac{-1.11}{10} \times 100\% = -11.1\%$$

Calculate the gain: $03-11 = \frac{10\text{V}}{11.1\text{V}} \times 100\% = 90.0\%$

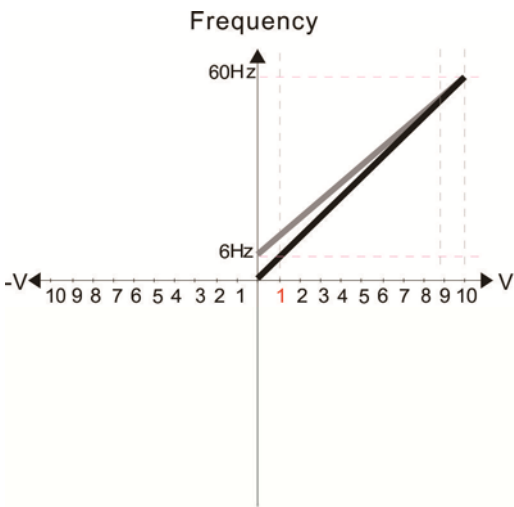

Pr.03-07~03-09 (Positive/Negative Bias Mode)

- 0: No bias
- 1: Lower than or equal to bias
- 2: Greater than or equal to bias
- 3: The absolute value of the bias voltage while serving as the center
- 4: Serve bias as the center

Pr.03-10 (Analog Frequency Command for Reverse Run)

- 0: Negative frequency is not valid. Forward and reverse run is controlled by digital keypad or external terminal.
- 1: Negative frequency is valid. Positive frequency = forward run; negative frequency = reverse run. Direction can not be switched by digital keypad or external terminal control.

Calculate the bias:

$$\frac{60-6\text{Hz}}{10\text{V}} = \frac{6-0\text{Hz}}{(0-XV)} \quad XV = \frac{100}{-9} = -1.11\text{V} \quad \therefore 03-03 = \frac{-1.11}{10} \times 100\% = -11.1\%$$

Calculate the gain: $03-11 = \frac{10\text{V}}{11.1\text{V}} \times 100\% = 90.0\%$

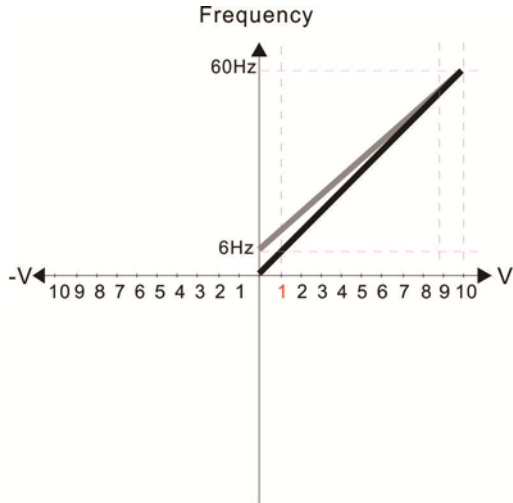

Pr.03-07~03-09 (Positive/Negative Bias Mode)

- 0: No bias
- 1: Lower than or equal to bias
- 2: Greater than or equal to bias
- 3: The absolute value of the bias voltage while serving as the center
- 4: Serve bias as the center

Pr.03-10 (Analog Frequency Command for Reverse Run)

- 0: Negative frequency is not valid. Forward and reverse run is controlled by digital keypad or external terminal.
- 1: Negative frequency is valid. Positive frequency = forward run; negative frequency = reverse run. Direction can not be switched by digital keypad or external terminal control.

Calculate the bias:

$$\frac{60-6\text{Hz}}{10\text{V}} = \frac{6-0\text{Hz}}{(0-XV)} \quad XV = \frac{100}{-9} = -1.11\text{V} \quad \therefore 03-03 = \frac{-1.11}{10} \times 100\% = -11.1\%$$

Calculate the gain: $03-11 = \frac{10\text{V}}{11.1\text{V}} \times 100\% = 90.0\%$

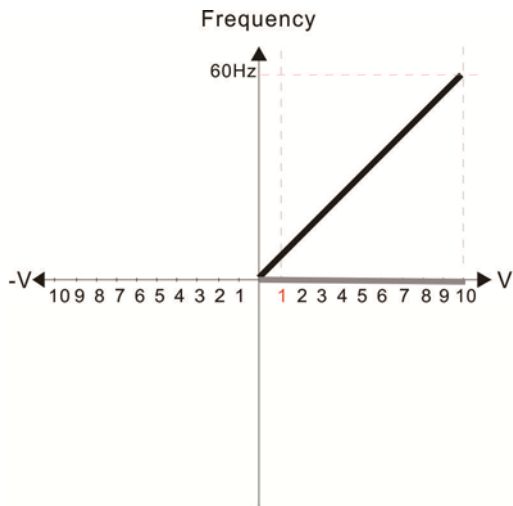

Pr.03-07~03-09 (Positive/Negative Bias Mode)

- 0: No bias
- 1: Lower than or equal to bias
- 2: Greater than or equal to bias
- 3: The absolute value of the bias voltage while serving as the center
- 4: Serve bias as the center

Pr.03-10 (Analog Frequency Command for Reverse Run)

- 0: Negative frequency is not valid. Forward and reverse run is controlled by digital keypad or external terminal.
- 1: Negative frequency is valid. Positive frequency = forward run; negative frequency = reverse run. Direction can not be switched by digital keypad or external terminal control.

Calculate the bias:

$$\frac{60-6\text{Hz}}{10\text{V}} = \frac{6-0\text{Hz}}{(0-XV)} \quad XV = \frac{100}{-9} = -1.11\text{V} \quad \therefore 03-03 = \frac{-1.11}{10} \times 100\% = -11.1\%$$

Calculate the gain: $03-11 = \frac{10\text{V}}{11.1\text{V}} \times 100\% = 90.0\%$

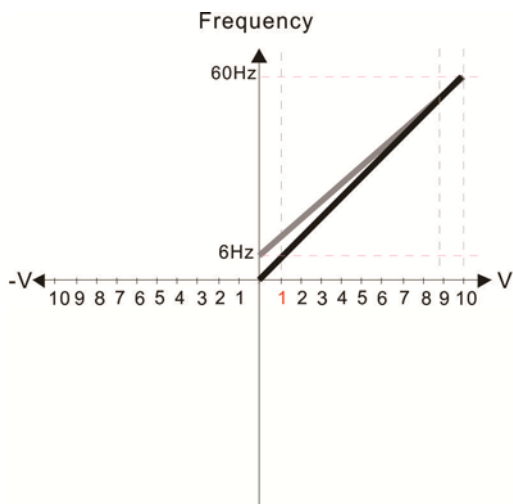

Pr.03-07~03-09 (Positive/Negative Bias Mode)

- 0: No bias
- 1: Lower than or equal to bias
- 2: Greater than or equal to bias
- 3: The absolute value of the bias voltage while serving as the center
- 4: Serve bias as the center

Pr.03-10 (Analog Frequency Command for Reverse Run)

- 0: Negative frequency is not valid. Forward and reverse run is controlled by digital keypad or external terminal.
- 1: Negative frequency is valid. Positive frequency = forward run; negative frequency = reverse run. Direction can not be switched by digital keypad or external terminal control.

Calculate the bias:

$$\frac{60-6\text{Hz}}{10\text{V}} = \frac{6-0\text{Hz}}{(0-XV)} \quad XV = \frac{100}{-9} = -1.11\text{V} \quad \therefore 03-03 = \frac{-1.11}{10} \times 100\% = -11.1\%$$

Calculate the gain: $03-11 = \frac{10\text{V}}{11.1\text{V}} \times 100\% = 90.0\%$

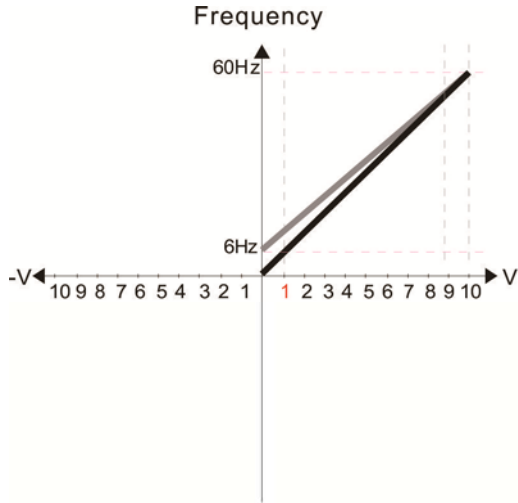

Pr.03-07~03-09 (Positive/Negative Bias Mode)

- 0: No bias
- 1: Lower than or equal to bias
- 2: Greater than or equal to bias
- 3: The absolute value of the bias voltage while serving as the center
- 4: Serve bias as the center

Pr.03-10 (Analog Frequency Command for Reverse Run)

- 0: Negative frequency is not valid. Forward and reverse run is controlled by digital keypad or external terminal.
- 1: Negative frequency is valid. Positive frequency = forward run; negative frequency = reverse run. Direction can not be switched by digital keypad or external terminal control.

Calculate the bias:

$$\frac{60-6\text{Hz}}{10\text{V}} = \frac{6-0\text{Hz}}{(0-XV)} \quad XV = \frac{100}{-9} = -1.11\text{V} \quad \therefore 03-03 = \frac{-1.11}{10} \times 100\% = -11.1\%$$

Calculate the gain: $03-11 = \frac{10\text{V}}{11.1\text{V}} \times 100\% = 90.0\%$

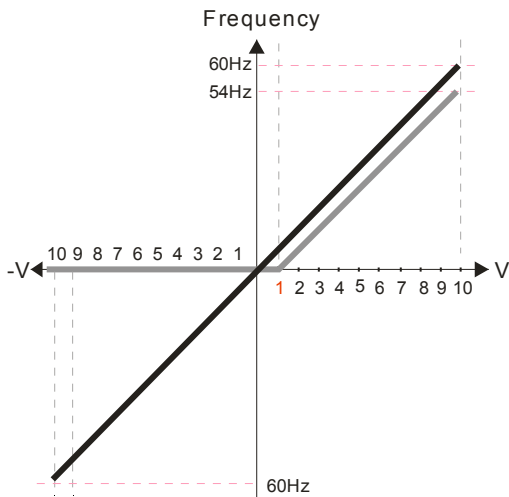

Pr.00-21=0 (Digital keypad control and d run in FWD direction)

Pr.03-05 Analog Positive Voltage Input Bias (AUI) = 10%

Pr.03-07~03-09 (Positive/Negative Bias Mode)

- 0: No bias
- 1: Lower than or equal to bias
- 2: Greater than or equal to bias
- 3: The absolute value of the bias voltage while serving as the center
- 4: Serve bias as the center

Pr.03-10 (Analog Frequency Command for Reverse Run)

- 0: Negative frequency is not valid. Forward and reverse run is controlled by digital keypad or external terminal.
- 1: Negative frequency is valid. Positive frequency = forward run; negative frequency = reverse run. Direction can not be switched by digital keypad or external terminal control.

Pr.00-13 Analog Positive Input Gain (AUI)= 100%

Pr.03-14 Analog Negative Input Gain (AUI)= 100%

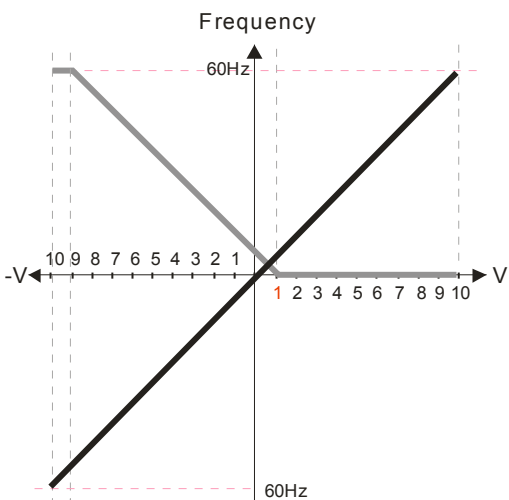

Pr.00-21=0 (Digital keypad control and d run in FWD direction)

Pr.03-05 Analog Positive Voltage Input Bias (AUI) = 10%

Pr.03-07~03-09 (Positive/Negative Bias Mode)

- 0: No bias
- 1: Lower than or equal to bias
- 2: Greater than or equal to bias
- 3: The absolute value of the bias voltage while serving as the center
- 4: Serve bias as the center

Pr.03-10 (Analog Frequency Command for Reverse Run)

- 0: Negative frequency is not valid. Forward and reverse run is controlled by digital keypad or external terminal.
- 1: Negative frequency is valid. Positive frequency = forward run; negative frequency = reverse run. Direction can not be switched by digital keypad or external terminal control.

Pr.00-13 Analog Positive Input Gain (AUI)= 100%

Pr.03-14 Analog Negative Input Gain (AUI)= 100%

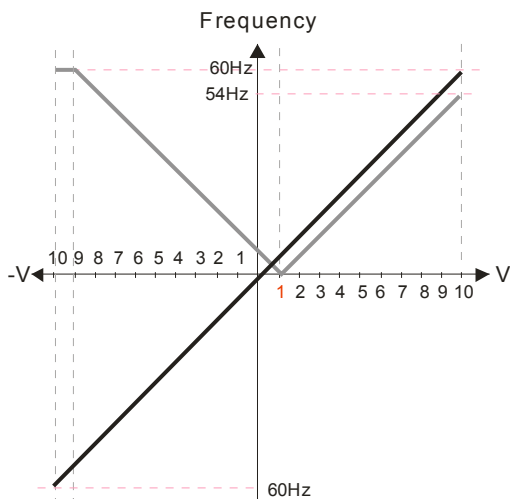

- Pr.00-21=0 (Digital keypad control and d run in FWD direction)
- Pr.03-05 Analog Positive Voltage Input Bias (AUI) = 10%
- Pr.03-07~03-09 (Positive/Negative Bias Mode)
 - 0: No bias
 - 1: Lower than or equal to bias
 - 2: Greater than or equal to bias
 - 3: The absolute value of the bias voltage while serving as the center
 - 4: Serve bias as the center

- Pr.03-10 (Analog Frequency Command for Reverse Run)
 - 0: Negative frequency is not valid. Forward and reverse run is controlled by digital keypad or external terminal.
 - 1: Negative frequency is valid. Positive frequency = forward run; negative frequency = reverse run. Direction can not be switched by digital keypad or external terminal control.

Pr.00-13 Analog Positive Input Gain (AUI)= 100%
 Pr.03-14 Analog Negative Input Gain (AUI)= 100%

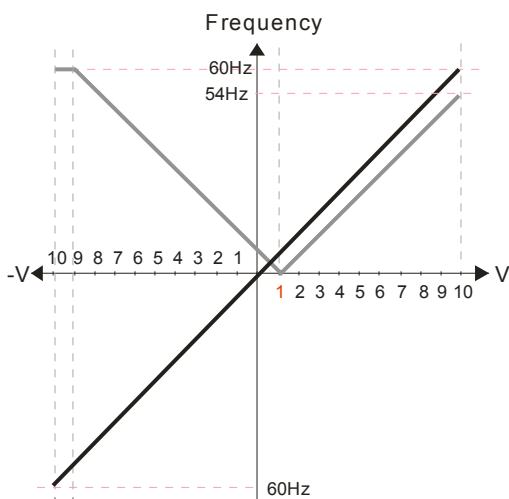

- Pr.00-21=0 (Digital keypad control and d run in FWD direction)
- Pr.03-05 Analog Positive Voltage Input Bias (AUI) = 10%
- Pr.03-07~03-09 (Positive/Negative Bias Mode)
 - 0: No bias
 - 1: Lower than or equal to bias
 - 2: Greater than or equal to bias
 - 3: The absolute value of the bias voltage while serving as the center
 - 4: Serve bias as the center

- Pr.03-10 (Analog Frequency Command for Reverse Run)
 - 0: Negative frequency is not valid. Forward and reverse run is controlled by digital keypad or external terminal.
 - 1: Negative frequency is valid. Positive frequency = forward run; negative frequency = reverse run. Direction can not be switched by digital keypad or external terminal control.

Pr.00-13 Analog Positive Input Gain (AUI)= 100%
 Pr.03-14 Analog Negative Input Gain (AUI)= 100%

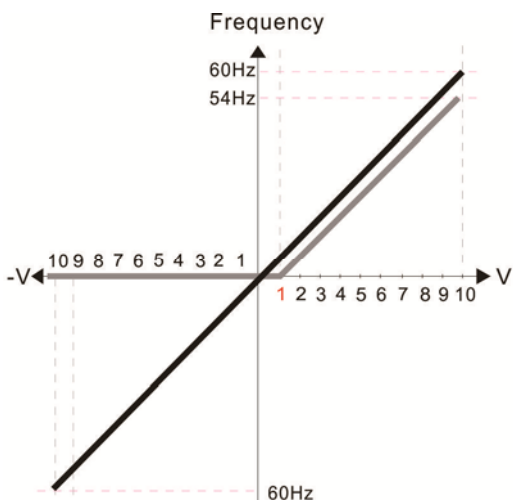

- Pr.00-21=0 (Digital keypad control and run in FWD direction)
- Pr.03-05 Analog Positive Voltage Input Bias (AUI) = 10%
- Pr.03-07~03-09 (Positive/Negative Bias Mode)
 - 0: No bias
 - 1: Lower than or equal to bias
 - 2: Greater than or equal to bias
 - 3: The absolute value of the bias voltage while serving as the center
 - 4: Serve bias as the center

Pr.03-13 Analog Positive Input Gain (AUI)= 100%
 Pr.03-14 Analog Negative Input Gain (AUI)= 100%

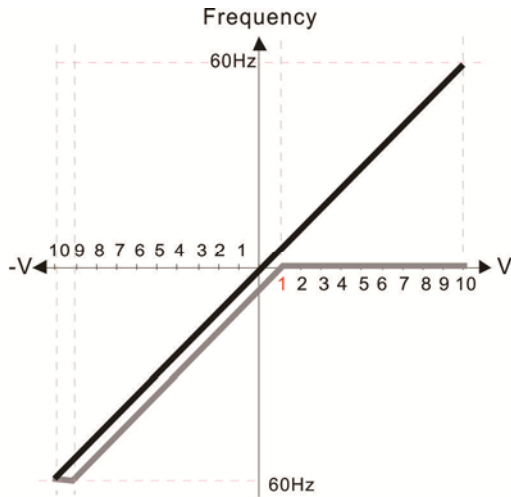

Pr.00-21=0 (Digital keypad control and run in FWD direction)
 Pr.03-05 Analog Positive Voltage Input Bias (AUI) = 10%

Pr.03-07~03-09 (Positive/Negative Bias Mode)

- 0: No bias
- 1: Lower than or equal to bias
- 2: Greater than or equal to bias
- 3: The absolute value of the bias voltage while serving as the center
- 4: Serve bias as the center

Pr.03-13 Analog Positive Input Gain (AUI)= 100%
 Pr.03-14 Analog Negative Input Gain (AUI)= 100%

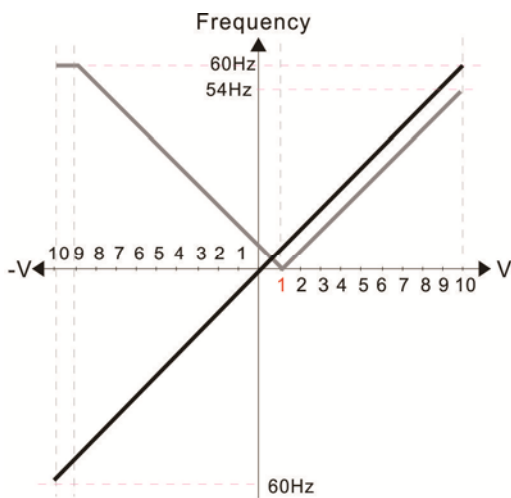

Pr.00-21=0 (Digital keypad control and run in FWD direction)
 Pr.03-05 Analog Positive Voltage Input Bias (AUI) = 10%

Pr.03-07~03-09 (Positive/Negative Bias Mode)

- 0: No bias
- 1: Lower than or equal to bias
- 2: Greater than or equal to bias
- 3: The absolute value of the bias voltage while serving as the center
- 4: Serve bias as the center

Pr.03-13 Analog Positive Input Gain (AUI)= 100%
 Pr.03-14 Analog Negative Input Gain (AUI)= 100%

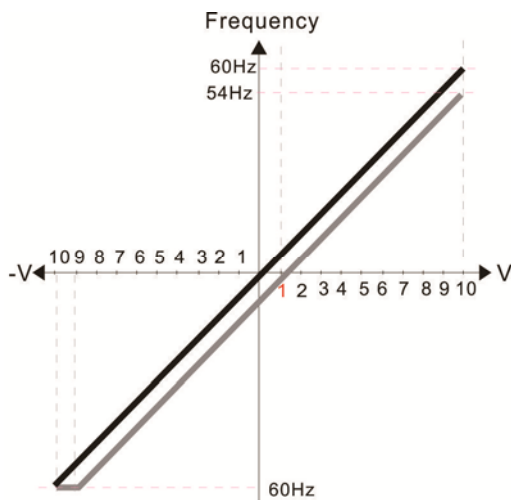

Pr.00-21=0 (Digital keypad control and run in FWD direction)
 Pr.03-05 Analog Positive Voltage Input Bias (AUI) = 10%

Pr.03-07~03-09 (Positive/Negative Bias Mode)

- 0: No bias
- 1: Lower than or equal to bias
- 2: Greater than or equal to bias
- 3: The absolute value of the bias voltage while serving as the center
- 4: Serve bias as the center

Pr.03-13 Analog Positive Input Gain (AUI)= 100%
 Pr.03-14 Analog Negative Input Gain (AUI)= 100%

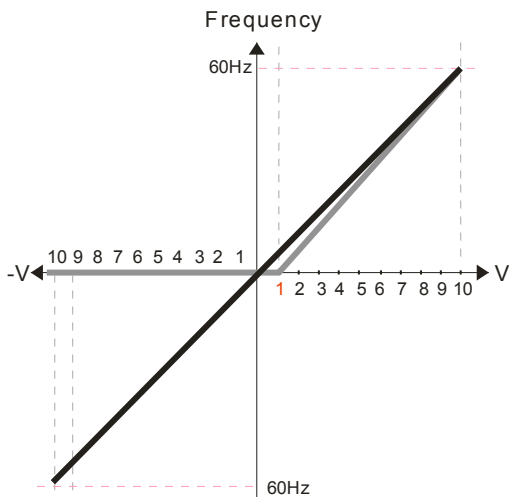

Pr.00-21=0 (Digital keypad control and run in FWD direction)
 Pr.03-05 Analog Positive Voltage Input Bias (AUI) = 10%
 Pr.03-07~03-09 (Positive/Negative Bias Mode)
 0: No bias
 1: Lower than or equal to bias
 2: Greater than or equal to bias
 3: The absolute value of the bias voltage while serving as the center
 4: Serve bias as the center

Pr.03-10 (Analog Frequency Command for Reverse Run)
 0: Negative frequency is not valid. Forward and reverse run is controlled by digital keypad or external terminal.
 1: Neagtive frequency is valid. Positive frequency = forward run; negative frequency = reverse run. Direction can not be switched by digital keypad or external teriminal control.

Pr.00-13 Analog Positive Input Gain (AUI)= 111.1%
 $(10/9) * 100\% = 111.1\%$

Pr.00-14 Analog Negative Input Gain (AUI) = 100%

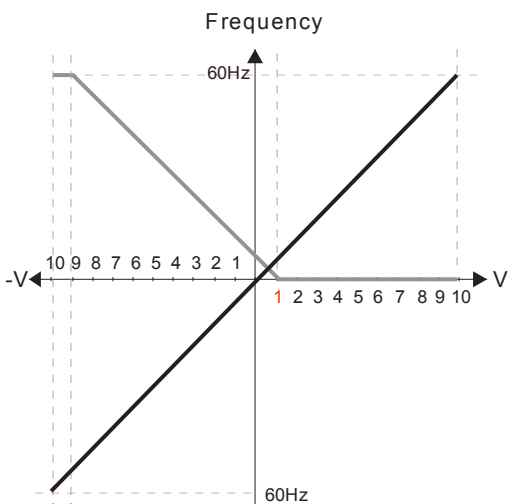

Pr.00-21=0 (Digital keypad control and run in FWD direction)
 Pr.03-05 Analog Positive Voltage Input Bias (AUI) = 10%
 Pr.03-07~03-09 (Positive/Negative Bias Mode)
 0: No bias
 1: Lower than or equal to bias
 2: Greater than or equal to bias
 3: The absolute value of the bias voltage while serving as the center
 4: Serve bias as the center

Pr.03-10 (Analog Frequency Command for Reverse Run)
 0: Negative frequency is not valid. Forward and reverse run is controlled by digital keypad or external terminal.
 1: Neagtive frequency is valid. Positive frequency = forward run; negative frequency = reverse run. Direction can not be switched by digital keypad or external teriminal control.

Pr.00-13 Analog Positive Input Gain (AUI)= 111.1%
 $(10/9) * 100\% = 111.1\%$

Pr.00-14 Analog Negative Input Gain (AUI) = 100%

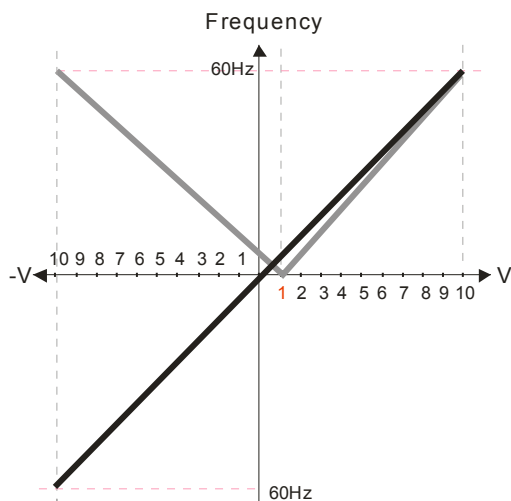

Pr.00-21=0 (Digital keypad control and run in FWD direction)
 Pr.03-05 Analog Positive Voltage Input Bias (AUI) = 10%
 Pr.03-07~03-09 (Positive/Negative Bias Mode)
 0: No bias
 1: Lower than or equal to bias
 2: Greater than or equal to bias
 3: The absolute value of the bias voltage while serving as the center
 4: Serve bias as the center

Pr.03-10 (Analog Frequency Command for Reverse Run)
 0: Negative frequency is not valid. Forward and reverse run is controlled by digital keypad or external terminal.
 1: Neagtive frequency is valid. Positive frequency = forward run; negative frequency = reverse run. Direction can not be switched by digital keypad or external teriminal control.

Pr.00-13 Analog Positive Input Gain (AUI)= 111.1%
 $(10/9) * 100\% = 111.1\%$

Pr.00-14 Analog Negative Input Gain (AUI) = 100%

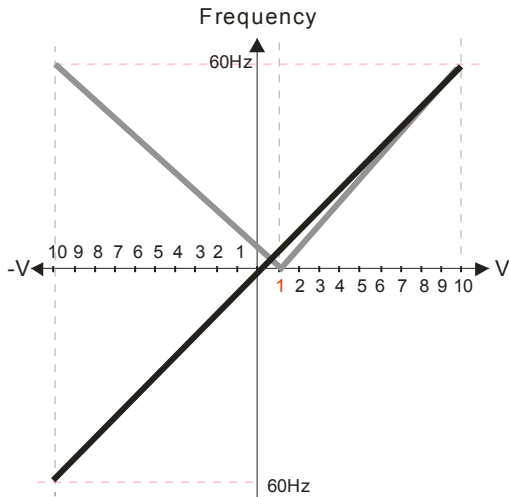

Pr.00-21=0 (Digital keypad control and run in FWD direction)
 Pr.03-05 Analog Positive Voltage Input Bias (AUI) = 10%
 Pr.03-07~03-09 (Positive/Negative Bias Mode)
 0: No bias
 1: Lower than or equal to bias
 2: Greater than or equal to bias
 3: The absolute value of the bias voltage while serving as the center
 4: Serve bias as the center

Pr.03-10 (Analog Frequency Command for Reverse Run)
 0: Negative frequency is not valid. Forward and reverse run is controlled by digital keypad or external terminal.
 1: Negative frequency is valid. Positive frequency = forward run; negative frequency = reverse run. Direction can not be switched by digital keypad or external terminal control.
 Pr.00-13 Analog Positive Input Gain (AUI)= 111.1%
 $(10/9) * 100\% = 111.1\%$
 Pr.00-14 Analog Negative Input Gain (AUI) = 100%

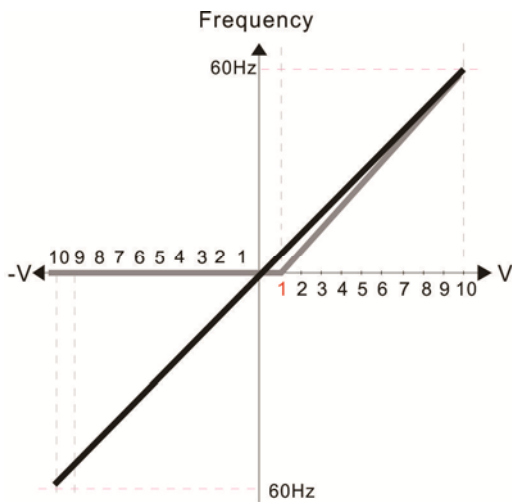

Pr.00-21=0 (Digital keypad control and run in FWD direction)
 Pr.03-05 Analog Positive Voltage Input Bias (AUI) = 10%
 Pr.03-07~03-09 (Positive/Negative Bias Mode)
 0: No bias
 1: Lower than or equal to bias
 2: Greater than or equal to bias
 3: The absolute value of the bias voltage while serving as the center
 4: Serve bias as the center
 Pr.00-13 Analog Positive Input Gain (AUI)= 111.1%
 $(10/9) * 100\% = 111.1\%$
 Pr.03-14 Analog Negative Input Gain (AUI)= 100%

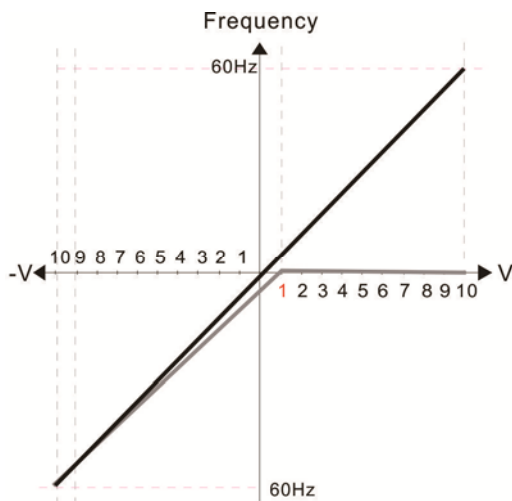

Pr.00-21=0 (Digital keypad control and run in FWD direction)
 Pr.03-05 Analog Positive Voltage Input Bias (AUI) = 10%
 Pr.03-07~03-09 (Positive/Negative Bias Mode)
 0: No bias
 1: Lower than or equal to bias
 2: Greater than or equal to bias
 3: The absolute value of the bias voltage while serving as the center
 4: Serve bias as the center
 Pr.03-13 Analog Positive Input Gain (AUI)= 100%
 Pr.03-14 Analog Negative Input Gain (AUI)= 90.9%
 $(10/11) * 100\% = 90.9\%$

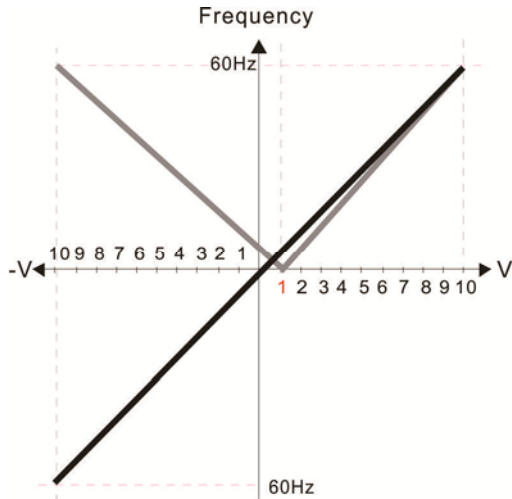

Pr.00-21=0 (Digital keypad control and run in FWD direction)
Pr.03-05 Analog Positive Voltage Input Bias (AUI) = 10%

Pr.03-07~03-09 (Positive/Negative Bias Mode)

- 0: No bias
- 1: Lower than or equal to bias
- 2: Greater than or equal to bias
- 3: The absolute value of the bias voltage while serving as the center
- 4: Serve bias as the center

Pr.00-13 Analog Positive Input Gain (AUI)= 111.1%
(10/9) *100% = 111.1%

Pr.03-14 Analog Negative Input Gain (AUI)= 90.9%
(10/11) *100% = 90.9%

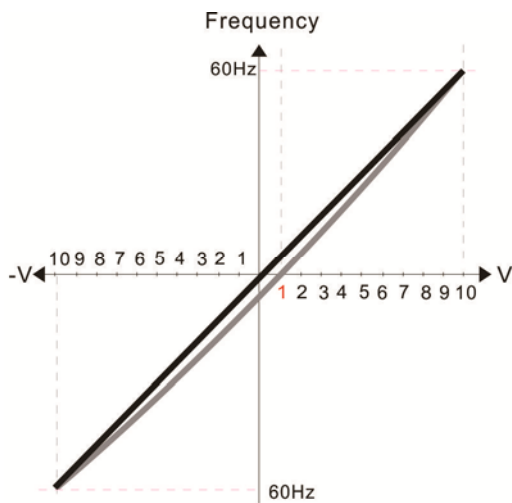

Pr.00-21=0 (Digital keypad control and run in FWD direction)
Pr.03-05 Analog Positive Voltage Input Bias (AUI) = 10%

Pr.03-07~03-09 (Positive/Negative Bias Mode)

- 0: No bias
- 1: Lower than or equal to bias
- 2: Greater than or equal to bias
- 3: The absolute value of the bias voltage while serving as the center
- 4: Serve bias as the center

Pr.00-13 Analog Positive Input Gain (AUI)= 111.1%
(10/9) *100% = 111.1%

Pr.03-14 Analog Negative Input Gain (AUI)= 90.9%
(10/11) *100% = 90.9%

↗	03-11	Analog Input Gain (AVI1)
↗	03-12	Analog Input Gain (ACI)
↗	03-13	Analog Positive Input Gain (AVI2)
↗	03-14	Analog Negative Input Gain (AVI2)

Factory Setting: 100.0

Settings -500.0~500.0%

📖 Parameters 03-03 to 03-14 are used when the source of frequency command is the analog voltage/current signal.

↗	03-15	Analog Input Filter Time (AVI1)
↗	03-16	Analog Input Filter Time (ACI)
↗	03-17	Analog Input Filter Time (AVI2)

Factory Setting: 0.01

Settings 0.00~20.00 sec

📖 These input delays can be used to filter noisy analog signal.

📖 When the setting of the time constant is too large, the control will be stable but the control response will be slow. When the setting of time constant is too small, the control response will be

faster but the control may be unstable. To find the optimal setting, please adjust the setting according to the control stable or response status.

03-18 Addition Function of the Analog Input

Factory Setting: 0

Settings 0: Disable (AVI1, ACI, AVI2)
1: Enable

When Pr03-18 is set to 1:

EX1: Pr03-00=Pr03-01=1 Frequency command= AVI1+ACI

EX2: Pr03-00=Pr03-01=Pr03-02=1 Frequency command = AVI1+ACI+AVI2

EX3: Pr03-00=Pr03-02=1 Frequency command = AVI1+AVI2

EX4: Pr03-01=Pr03-02=1 Frequency command = ACI+AVI2

When Pr.03-18 is set to 0 and the analog input setting is the same, the priority for AVI1, ACI and AVI2 are AVI1>ACI>AVI2.

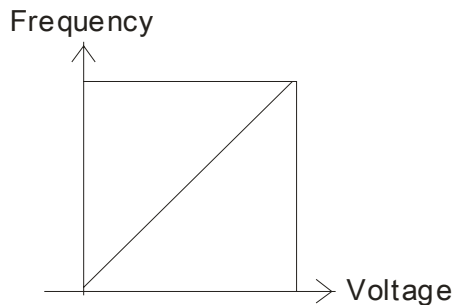

$$F_{\text{command}} = [(a_y \text{ bias}) * \text{gain}] * \frac{F_{\text{max}}(01-00)}{10\text{V or } 16\text{mA or } 20\text{mA}}$$

F_{command} : the corresponding frequency for 10V or 20mA
 a_y : 0-10V, 4-20mA, 0-20mA
 bias: Pr.03-03, Pr. 03-04, Pr.03-05
 gain: Pr.03-11, Pr.03-12, Pr.03-13, Pr.03-14

03-19 Treatment to 4-20mA Analog Input Signal Loss

Factory Setting: 0

Settings 0: Disable
1: Continue operation at the last frequency
2: Decelerate to stop
3: Stop immediately and display ACE

This parameter determines the behavior when 4~20mA signal is loss, when AVIc(Pr.03-28=2) or ACIc (03-29=0).

When Pr.03-28 is not set to 2, it means the voltage input to AVI terminal is 0-10V or 0-20mA. At this moment, Pr.03-19 will be invalid.

When Pr.03-29 is set to 1, it means the voltage input to ACI terminal is for 0-10V. At this moment, Pr.03-19 will be invalid.

When setting is 1 or 2, it will display warning code "AnL" on the keypad. It will be blinking until the loss of the ACI signal is recovered.

When the motor drive stops, the condition of warning does not exist, then the warning will disappear.

03-20 Multi-function Output 1 (AFM1)

Factory Setting: 0

03-23 Multi-function Output 2 (AFM2)

Factory Setting: 0

Settings 0~23

Function Chart

Settings	Functions	Descriptions
0	Output frequency (Hz)	Max. frequency Pr.01-00 is regarded as 100%.
1	Frequency command (Hz)	Max. frequency Pr.01-00 is regarded as 100%.
2	Motor speed (Hz)	600Hz is regarded as 100%
3	Output current (rms)	(2.5 X rated current) is regarded as 100%
4	Output voltage	(2 X rated voltage) is regarded as 100%
5	DC Bus Voltage	450V (900V)=100%
6	Power factor	-1.000~1.000=100%
7	Power	Rated power is regarded as 100%
8	Reserved	
9	AVI1	0~10V/ 0~20mA/ 4~20mA =0~100%
10	ACI	4~20mA/ 0~10V/ 0~20mA =0~100%
11	AVI2	0~10V/ 0~20mA/ 4~20mA =0~100%
12~19	Reserved	
20	Output for CANopen control	For CANopen analog output
21	RS485 analog output	For communication output (CMC-MOD01, CMC-EIP01, CMC-PN01, CMC-DN01)
22	Analog output for communication card	For communication output (CMC-MOD01, CMC-EIP01, CMC-PN01, CMC-DN01)
23	Constant voltage/current output	Pr.03-32 and Pr.03-33 controls voltage/current output level 0~100% of Pr.03-32 corresponds to 0~10V of AFM1.

03-21 Gain of Analog Output 1 (AFM1)

Factory Setting: 100.0

03-24 Gain of Analog Output 2 (AFM2)

Factory Setting: 100.0

Settings 0~500.0%

 It is used to adjust the analog voltage level (Pr.03-20) that terminal AFM outputs.

 This parameter is set the corresponding voltage of the analog output 0.

03-22 Analog Output 1 when in REV Direction (AFM1)

Factory Setting: 0

03-25 Analog Output 2 when in REV Direction (AFM2)

Factory Setting: 0

- Settings 0: Absolute value in REV direction
 1: Output 0V in REV direction; output 0-10V in FWD direction
 2: Output 5-0V in REV direction; output 5-10V in FWD direction

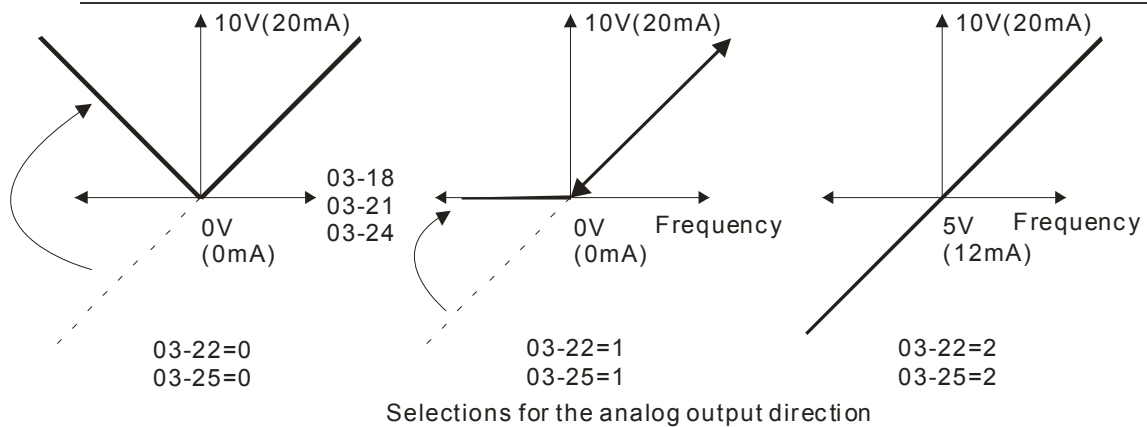

03-26 Reserved

03-27 AFM2 Output Bias

Factory Setting: 0.00

Settings -100.00~100.00%

Example 1, AFM2 0-10V is set output frequency, the output equation is

$$10V \times \left(\frac{\text{Output Frequency}}{01-00} \right) \times 03-24 + 10V \times 03-27$$

Example 2, AFM2 0-20mA is set output frequency, the output equation is

$$20mA \times \left(\frac{\text{Output Frequency}}{01-00} \right) \times 03-24 + 20mA \times 03-27$$

Example 3, AFM2 4-20mA is set output frequency, the output equation is

$$4mA + 16mA \times \left(\frac{\text{Output Frequency}}{01-00} \right) \times 03-24 + 16mA \times 03-27$$

This parameter can set the corresponded voltage of 0 for analog output.

03-28 AVI Selection

Factory Setting: 0

- Settings 0: 0-10V
 1: 0-20mA
 2: 4-20mA

03-29 ACI Selection

Factory Setting: 0

- Settings 0: 4-20mA
 1: 0-10V
 2: 0-20mA

When changing the input mode, please check if the switch of external terminal (SW3, SW4) corresponds to the setting of Pr.03-28~03-29.

03-30 Status of PLC Output Terminal

Factory Setting: 0000h

Settings 0~65535

Monitor the status of PLC analog output terminals

📖 P.03-30 shows the external multi-function output terminal that used by PLC.

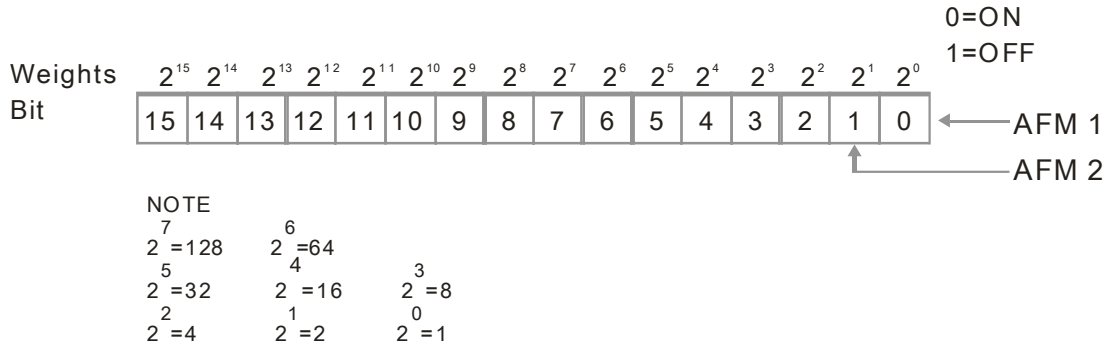

📖 For Example:

If the value of Pr.03-30 displays 0002h(Hex), it means AFM1 and AFM2 are used by PLC.

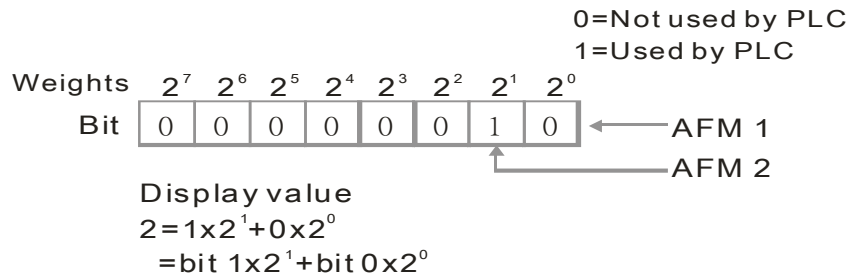

↗ **03-31** AFM2 Output Selection

Factory Setting: 0

Settings 0: 0-20mA output

1: 4-20mA output

↗ **03-32** AFM1 DC output setting level

↗ **03-33** AFM2 DC Output Setting Level

Factory Setting: 0.00

Settings 0.00~100.00%

📖 Pair with Multi-Function Output : 23, Pr03-32 and Pr03-33 can output constant AFM voltage.

📖 Set Pr03-32 between 0 to 100%.00 to correspond to 0~10V of AFM1

📖 Set Pr03-33 between 0 to 100.00 % to correspond to 0~10V of AFM2

↗ **03-34** AFM1 Output Selection

Factory Setting: 0

Settings 0: 0-20mA output

1: 4-20mA output

↗	03-35	AFM1 Filter Output Time	
↗	03-36	AFM2 Filter Output Time	Factory Setting: 0.01
		Settings	0.00~20.00 Seconds

	03-37	Reserved	
	~		
	03-43		

↗	03-44	MO by AI level	Factory Setting: 0
		Settings	0: AVI1 1: ACI 2: AVI2

↗	03-45	AI Upper level	Factory Setting: 50.00%
		Settings	-100.00%~100.00%

↗	03-46	AI Lower level	Factory Setting: 100.00%
		Settings	-100.00%~100.00%

 This function requires working with Multi-function Output item “67” Analog signal level achieved. The MO active when AI input level is higher than Pr03-45 AI Upper level. The MO shutoffs when the AI input is lower that Pr03-46 AI Lower level.

 AI Upper level must be higher than AI Lower level

	03-47	Reserved	
	~		
	03-49		

↗	03-50	Analog Input Curve Selection	Factory Setting: 0
		Settings	0: Regular Curve 1: 3 point curve of AVI1 2: 3 point curve of ACI 3: 3 point curve of AVI 1& ACI 4: 3 point curve of AVI2 5: 3 point curve of AVI 1& AVI2 6: 3 point curve of ACI & AVI2 7: 3 point curve of AVI1 & ACI & AVI2

 Set Pr03-50 = 0, all analog input signal are calculated by using bias and gain.

 Set Pr03-50 =1, AVI1 is calculated by using frequency and voltage/current in corresponding format (Pr03-51 ~ Pr03-56), other analog input signals are calculated by using bias and gain.

- 📖 Set Pr03-50 =2, ACI is calculated by using frequency and voltage/current in corresponding format (Pr03-57 ~ Pr03-62), other analog input signals are calculated by using bias and gain.
- 📖 Set Pr03-50 =3, AVI1 and ACI are calculated by using frequency and voltage/current in corresponding format (Pr03-51 ~ Pr03-62), other analog input signals are calculated by using bias and gain.
- 📖 Set Pr03-50 =4, AVI2 is calculated by using frequency and voltage in corresponding format (Pr03-63 ~ Pr03-68), other analog input signals are calculated by using bias and gain.
- 📖 Set Pr03-50=5, AVI and AVI2 are calculated by using frequency and voltage/current in corresponding format (Pr03-51~ Pr03-5, Pr03-63~Pr03-68), other analog input signal are calculated by using bias and gain.
- 📖 Set Pr03-50=6, ACI and AVI2 are calculated by using frequency and voltage/current in corresponding format (Pr03-57 ~ Pr03-68), other analog input signals are calculated by using bias and gain.
- 📖 Set Pr03-50=7, all the analog input signals are calculated by using frequency and voltage/current in corresponding format (Pr03-51 ~ Pr03-68)

↗	03-51	AVI1 Low Point	Factory Setting: 0.00
	Settings	03-28=0, 0.00~10.00V 03-28≠0, 0.00~20.00mA	
↗	03-52	AVI1 Proportional Low Point	Factory Setting: 0.00
	Settings	-100.00~100.00%	
↗	03-53	AVI1 Mid Point	Factory Setting: 5.00
	Settings	03-28=0, 0.00~10.00V 03-28≠0, 0.00~20.00mA	
↗	03-54	AVI1 Proportional Mid Point	Factory Setting: 50.00
	Settings	0.00~100.00%	
↗	03-55	AVI1 High Point	Factory Setting: 10.00
	Settings	03-28=0, 0.00~10.00V 03-28≠0, 0.00~20.00mA	
↗	03-56	AVI1 Proportional High Point	Factory Setting: 100.00
	Settings	0.00~100.00%	

- 📖 When Pr.03-28 = 0, AVI1 setting is 0-10V and the unit is in voltage (V).
- 📖 When Pr.03-28 ≠ 0, AVI1 setting is 0-20mA or 4-20mA and the unit is in current (mA).
- 📖 When setting analog input AVI1 to frequency command, it 100% corresponds to Fmax (Pr.01-00 Max. operation frequency).

- 📖 The 3 parameters (Pr03-51, Pr03-53 and Pr03-55) must meet the following argument: $P03-51 < P03-53 < P03-55$. The 3 proportional points (Pr03-52, Pr03-54 and Pr03-56) doesn't have any limit. Between two points is a linear calculation. The ACI and AVI2 are same as AVI1.
- 📖 The output % will become 0% when the AVI input value is lower than low point setting.

For example:

Pr 03-51=0V ; Pr 03-52=0%

Pr 03-53=5V ; Pr 03-54=50%

Pr 03-55=10V ; Pr 03-56=100%

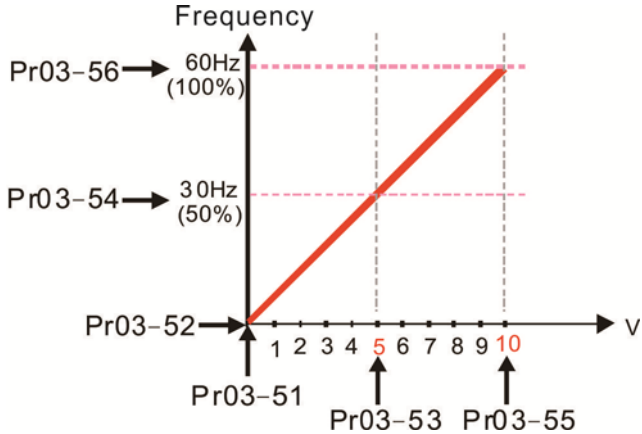

Pr 03-51=0V ; Pr 03-52=100%

Pr 03-53=5V ; Pr 03-54=50%

Pr 03-55=10V ; Pr 03-56=0%

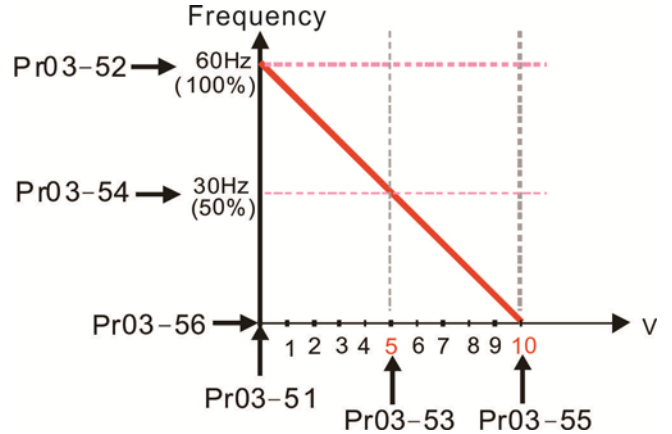

Pr 03-51=1V ; Pr 03-52=10%

Pr 03-53=5V ; Pr 03-54=50%

Pr 03-55=10V ; Pr 03-56=100%

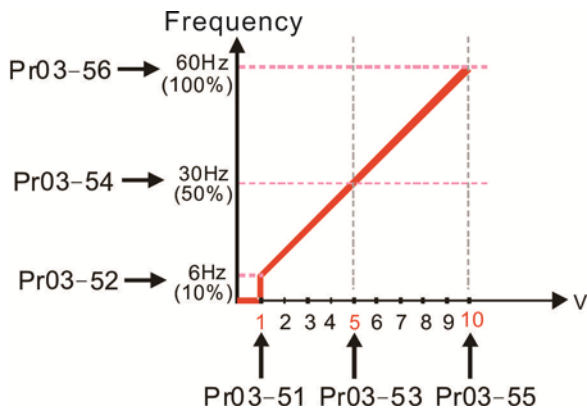

Pr 03-51=1V ; Pr 03-52=10%

Pr 03-53=5V ; Pr 03-54=50%

Pr 03-55=9V ; Pr 03-56=100%

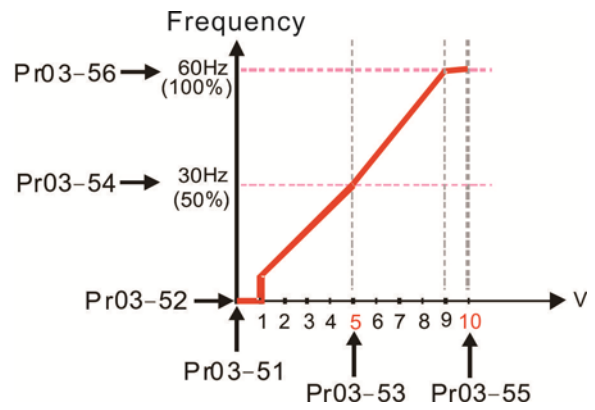

Pr 03-51=0V ; Pr 03-52=10%

Pr 03-53=5V ; Pr 03-54=50%

Pr 03-55=10V ; Pr 03-56=100%

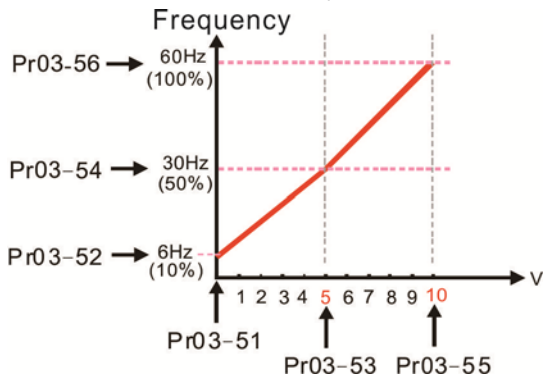

Pr 03-51=1V ; Pr 03-52=0%

Pr 03-53=5V ; Pr 03-54=50%

Pr 03-55=10V ; Pr 03-56=100%

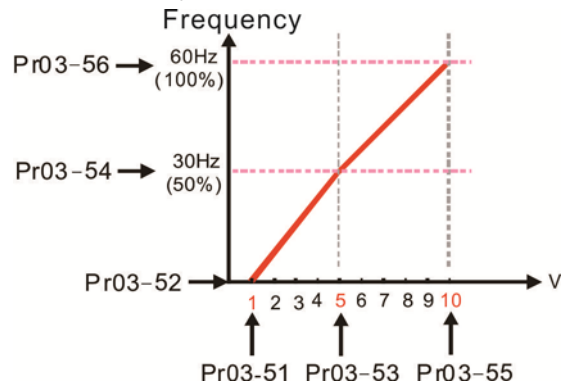

↗	03-57 ACI Low Point	Factory Setting: 4.00
	Settings Pr.03-29=1, 0.00~10.00V Pr.03-29≠1, 0.00~20.00mA	
↗	03-58 ACI Proportional Low Point	Factory Setting: 0.00
	Settings 0.00~100.00%	
↗	03-59 ACI Mid Point	Factory Setting: 12.00
	Settings 03-29=1, 0.00~10.00V 03-29≠1, 0.00~20.00mA	
↗	03-60 ACI Proportional Mid Point	Factory Setting: 50.00
	Settings 0.00~100.00%	
↗	03-61 ACI High Point	Factory Setting: 20.00
	Settings 03-29=1, 0.00~10.00V 03-29≠1, 0.00~20.00mA	
↗	03-62 ACI Proportional High Point	Factory Setting: 100.00
	Settings 0.00~100.00%	
	<p>📖 When Pr.03-29=1, ACI setting is 0-10V and the unit is in voltage (V).</p> <p>📖 When Pr.03-29≠1, ACI setting is 0-20mA or 4-20mA and the unit is in current (mA).</p> <p>📖 When setting analog input ACI to frequency command, it 100% corresponds to Fmax (Pr.01-00 Max. operation frequency).</p> <p>📖 The 3 parameters (Pr03-57, Pr03-59 and Pr03-61) must meet the following argument: P03-57 < P03-59 < P03-61. The 3 proportional points (Pr03-58, Pr03-60 and Pr03-62) doesn't have any limit. Between two points is a linear calculation.</p> <p>📖 The output % will become 0% when the ACI input value is lower than low point setting. For example: P03-57 = 2mA; P03-58 = 10%. The output will become 0% when AVI input is lower than 2mA. If the ACI input is swing between 2mA and 2.1mA, drive's output frequency will beats between 0% and 10%.</p>	
↗	03-63 Positive AVI2 Voltage Low Point	Factory Setting: 0.00
	Settings 0.00~10.00V	
↗	03-64 Positive AVI2 Voltage Proportional Low Point	Factory Setting: 0.00
	Settings 0.00%~100.00%	

- ↗ **03-65** Positive AVI2 Voltage Mid Point Factory Setting: 5.00
 Settings 0.00~10.00V
- ↗ **03-66** Positive AVI2 Voltage Proportional Mid Point Factory Setting: 50.00
 Settings 0.00%~100.00%
- ↗ **03-67** Positive AVI2 Voltage High Point Factory Setting: 10.00
 Settings 0.00~10.00V
- ↗ **03-68** Positive AVI2 Voltage Proportional High Point Factory Setting: 100.00
 Settings 0.00%~100.00%

- 📖 When AVI2 Selection (Pr03-28) is AVI1, the setting range of Pr03-51, Pr03-52, Pr03-55 have to be 0.00~10.00 or 0.00~20.00.
- 📖 When ACI Selection (Pr03-29) is AVI1, the setting range of Pr03-57, Pr03-59 and Pr03-61 have to be 0.00~10.00 or 0.00~20.00.
- 📖 The analog input values can be set at Pr03-51 ~ Pr03-68 and the maximum operating frequency can be set at Pr01-00. The corresponding functions of open-loop control are shown as image below.

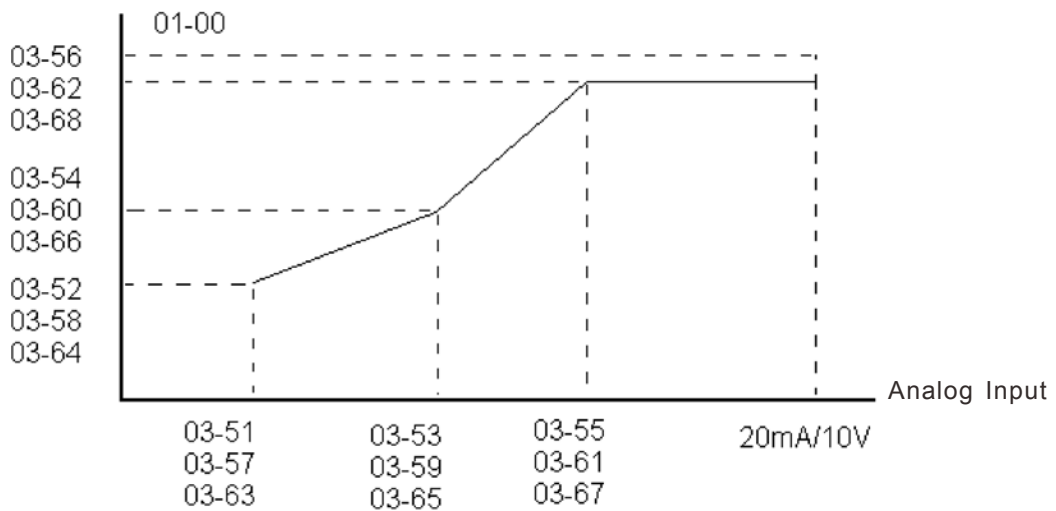





04 Multi-Step Speed Parameters ✎ This parameter can be set during operation.

✎	04-00	1st Step Speed Frequency
✎	04-01	2nd Step Speed Frequency
✎	04-02	3rd Step Speed Frequency
✎	04-03	4th Step Speed Frequency
✎	04-04	5th Step Speed Frequency
✎	04-05	6th Step Speed Frequency
✎	04-06	7th Step Speed Frequency
✎	04-07	8th Step Speed Frequency
✎	04-08	9th Step Speed Frequency
✎	04-09	10th Step Speed Frequency
✎	04-10	11th Step Speed Frequency
✎	04-11	12th Step Speed Frequency
✎	04-12	13th Step Speed Frequency
✎	04-13	14th Step Speed Frequency
✎	04-14	15th Step Speed Frequency

Factory Setting: 0.00

Settings 0.00~599.00Hz

-  The Multi-function Input Terminals (refer to setting 1~4 of Pr.02-01~02-08 and 02-26~02-31) are used to select one of the AC motor drive Multi-step speeds (max. 15 speeds). The speeds (frequencies) are determined by Pr.04-00 to 04-14 as shown in the following.
 -  The run/stop command can be controlled by the external terminal/digital keypad/communication via Pr.00-21.
 -  Each one of multi-step speeds can be set within 0.00~600.00Hz during operation.
 -  Explanation of the timing diagram for multi-step speeds and external terminals
- The Related parameter settings are:
1. Pr.04-00~04-14: setting multi-step speeds (to set the frequency of each step speed)
 2. Pr.02-01~02-08, 02-26~02-31: setting multi-function input terminals (multi-step speed 1~4)
 - Related parameters: 01-22 JOG Frequency, 02-01 Multi-function Input Command 1 (MI1), 02-02 Multi-function Input Command 2 (MI2), 02-03 Multi-function Input Command 3 (MI3), 02-04 Multi-function Input Command 4 (MI4)

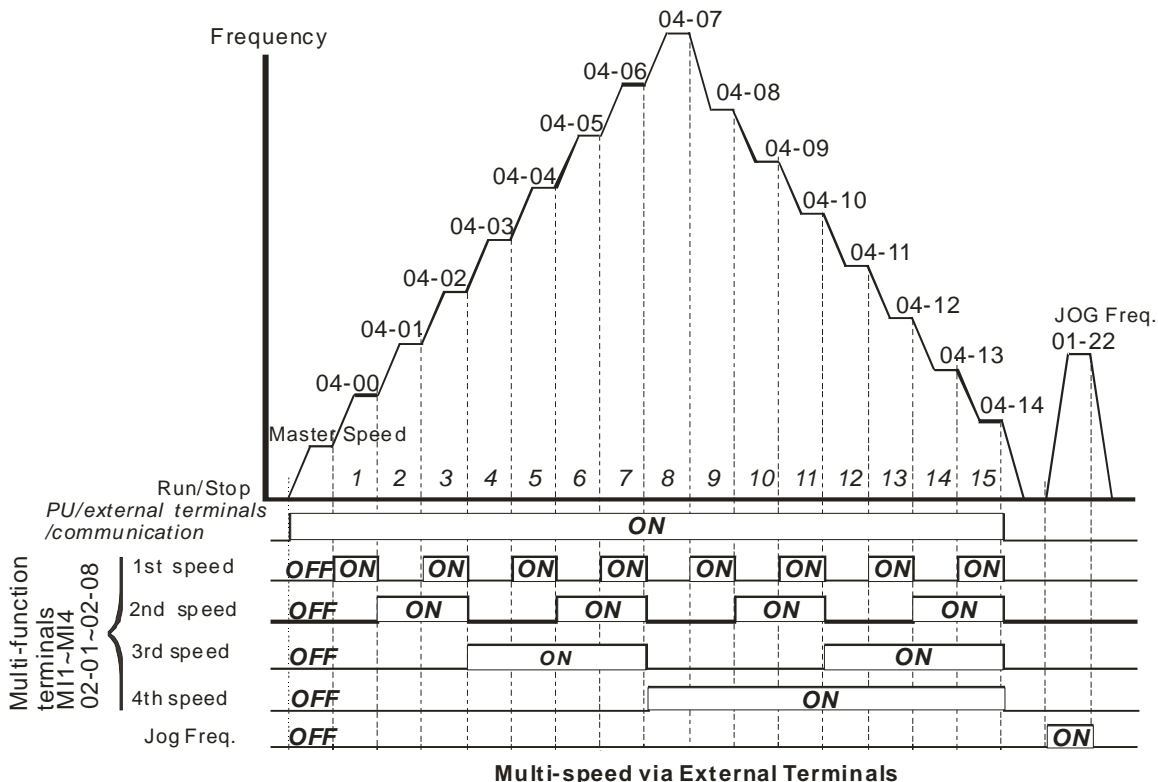

04-15

~ Reserved

04-49

- ✓ **04-50** PLC Buffer 0
- ✓ **04-51** PLC Buffer 1
- ✓ **04-52** PLC Buffer 2
- ✓ **04-53** PLC Buffer 3
- ✓ **04-54** PLC Buffer 4
- ✓ **04-55** PLC Buffer 5
- ✓ **04-56** PLC Buffer 6
- ✓ **04-57** PLC Buffer 7
- ✓ **04-58** PLC Buffer 8
- ✓ **04-59** PLC Buffer 9
- ✓ **04-60** PLC Buffer 10
- ✓ **04-61** PLC Buffer 11
- ✓ **04-62** PLC Buffer 12
- ✓ **04-63** PLC Buffer 13
- ✓ **04-64** PLC Buffer 14
- ✓ **04-65** PLC Buffer 15
- ✓ **04-66** PLC Buffer 16
- ✓ **04-67** PLC Buffer 17

↗ **04-68** PLC Buffer 18

↗ **04-69** PLC Buffer 19

Factory Setting: 0

Settings 0~65535

 The Pr 04-50~Pr04-69 can be combined with PLC or HMI programming for variety application.

05 Motor Parameters

✎ This parameter can be set during operation.

05-00 Motor Auto Tuning

Factory Setting: 0

- Settings
- 0: No function
 - 1: Rolling test for induction motor(IM) (Rs, Rr, Lm, Lx, no-load current) [motor running]
 - 2: Static test for induction motor [motor not running]
 - 5: Dynamic test for PM (SPM) motor [motor running]
 - 13: Static test for PM(IPM) motor

Induction Motor

- 📖 This parameter can conduct motor parameters auto test. When setting as 1, motor will roll for more than one round.
- 📖 Press **【Run】** to begin auto tuning when the setting is done. The measured value will be written into motor 1 (Pr.05-05 ~05-09, Rs, Rr, Lm, Lx, no-load current) and motor 2 (Pr.05-17 to Pr.05-21) automatically.

To begin AUTO-Tuning in rolling test:

1. Make sure that all the parameters are set to factory settings (Pr00-02=9 or 10) and the motor wiring is correct.
2. Make sure the motor has no-load before executing auto-tuning and the shaft is not connected to any belt or gear motor. It is recommended to set to 2 if the motor can't separate from the load.
3. Please set motor related parameters according to motor nameplate.

	Motor 1 Parameter	Motor 2 Parameter
Motor Rated Frequency	01-01	01-35
Motor Rated Voltage	01-02	01-36
Motor Full-load Current	05-01	05-13
Motor Rated Power	05-02	05-14
Motor Rated Speed	05-03	05-15
Motor Pole Numbers	05-04	05-16

4. Set Pr.05-00=1 and press **【Run】**, the drive will begin auto-tuning. Please be aware of the motor that it starts spinning as **【Run】** is pressed.
5. When auto-tuning is completed, please check if the measured values are written into motor 1 (Pr.05-05 ~05-09) and motor 2 (Pr.05-17 ~05-21) automatically.
6. Mechanical equivalent circuit

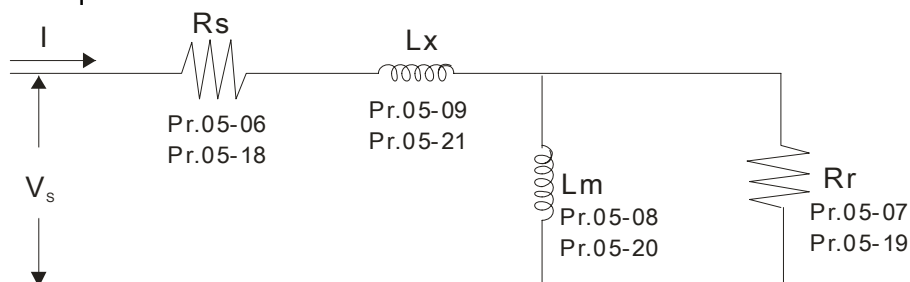

✎ If Pr.05-00 is set to 2 (static test), user needs to input the no-load current value of motor into Pr.05-05 for motor 1/Pr.05-17 for motor 2.

 **NOTE**

- ☑ When auto-tuning 2 motors, it needs to set multi-function input terminals (setting 14) or change Pr.05-22 for motor 1/motor 2 selection.
- ☑ The no-load current is usually 20~50% X rated current.
- ☑ The rated speed can not be greater than or equal to $120f/p$ (f = rated frequency Pr.01-01/01-35; P : number of motor poles Pr.05-04/05-16).

05-01 Full-load Current of Induction Motor 1 (A)

Unit: Ampere

Factory Setting: ###

Settings 10 to 120% of drive's rated current

-  This value should be set according to the rated current of the motor as indicated on the motor nameplate. The factory setting is 90% X rated current.
Example: The rated current for 7.5HP (5.5kW) is 25 and factory setting is 22.5A. The range for setting will be 10~30A. ($25 \times 40\% = 10A$ and $25 \times 120\% = 30A$)

 **05-02** Rated Power of Induction Motor 1(kW)

Factory Setting: ###

Settings 0~655.35 kW

-  It is used to set rated power of the motor 1. The factory setting is the power of the drive.



 **05-03** Rated Speed of Induction Motor 1 (rpm)

Factory Setting:

1710 (60Hz 4 poles)

1410 (50Hz 4 poles)



Settings 0~65535

-  It is used to set the rated speed of the motor according to the motor nameplate.
 Before set up Pr05-04, this parameter must be set.

05-04 Pole Number of Induction Motor 1

Factory Setting: 4

Settings 2~20

-  It is used to set the number of motor poles (must be an even number).
 Set up Pr.05-04 after setting up Pr. 01-01 and Pr.05-03 to make sure motor operate normally.
 For example: the Pr05-04 factory setting range is "2~4". If use a 6 poles motor, to set up Pr01-01 and Pr05-03 according the motor nameplate, then the Pr05-04 setting range will become 2~6 automatically.

05-05 No-load Current of Induction Motor 1 (A)

Unit: Ampere

Factory Setting: ###

Settings 0 to the factory setting in Pr.05-01

-  The factory setting is 40% motor rated current.

For model with 110kW and above, default setting is 20% motor rated current.

05-06 Stator Resistance(Rs) of Induction Motor 1

05-07 Rotor Resistance(Rr) of Induction Motor 1

Factory Setting: #.###

Settings 0~65.535Ω

05-08 Magnetizing Inductance(Lm) of Induction Motor 1

05-09 Stator inductance(Lx) of Induction Motor 1

Factory Setting: #.#

Settings 0~6553.5mH

05-10 ~ Reserved

05-12

05-13 Full-load Current of Induction Motor 2 (A)

Unit: Ampere

Factory Setting: #.##

Settings 10~120%

This value should be set according to the rated frequency of the motor as indicated on the motor nameplate. The factory setting is 90% X rated current.

Example: The rated current for 7.5HP (5.5kW) is 25A and factory setting is 22.5A. The range for setting will be 10~30A.(25*40%=10A and 25*120%=30A)

05-14 Rated Power of Induction Motor 2 (kW)

Factory Setting: #.###

Settings 0~655.35 kW

It is used to set rated power of the motor 2. The factory setting is the power of the drive.

05-15 Rated Speed of Induction Motor 2 (rpm)

Factory Setting: 1710

Settings 0~65535

It is used to set the rated speed of the motor according to the motor nameplate.

05-16 Pole Number of Induction Motor 2

Factory Setting: 4

Settings 2~20

It is used to set the number of motor poles (must be an even number).

Set up Pr.05-16 after setting up Pr. 01-35 and Pr.05-15 to make sure motor operate normally.

05-17 No-load Current of Induction Motor 2 (A)

Unit: Ampere

Factory Setting: #.###

Settings 0 to the factory setting in Pr.05-13

The factory setting is 40% motor rated current.

For model with 90kW and above, default setting is 20% motor rated current.

05-18 Stator Resistance (Rs) of Induction Motor 2

05-19 Rotor Resistance (Rr) of Induction Motor 2

Factory Setting: 0.000

Settings 0~65.535Ω

05-20 Magnetizing Inductance (Lm) of Induction Motor 2

05-21 Stator Inductance (Lx) of Induction Motor 2

Factory Setting: 0.0

Settings 0~6553.5 mH

05-22 Induction Motor 1/ 2 Selection

Factory Setting: 1

Settings 1: Motor 1

2: Motor 2

It is used to set the motor that driven by the AC motor drive.

05-23 Frequency for Y-connection/Δ-connection Switch of Induction Motor

Factory Setting: 60.00

Settings 0.00~599.00Hz

05-24 Y-connection/Δ-connection Switch of Induction Motor IM

Factory Setting: 0

Settings 0: Disable

1: Enable

05-25 Delay Time for Y-connection/Δ-connection Switch of Induction Motor

Factory Setting: 0.200

Settings 0.000~60.000 sec

P.05-23 and Pr.05-25 are applied in the wide range motors and the motor coil will execute the switch of Y-connection/Δ-connection as required. (The wide range motors has relation with the motor design. In general, it has higher torque at low speed and Y-connection and it has higher speed at high speed and connection.

Pr.05-24 is used to enable/disable Y-connection/Δ- connection Switch.

When Pr.05-24 is set to 1, the drive will select by Pr.05-23 setting and current motor frequency to switch motor to Y-connection or Δ- connection. At the same time, it will also affect motor parameters.

Pr.05-25 is used to set the switch delay time of Y-connection/Δ- connection.

When output frequency reaches Y-connection/Δ-connection switch frequency, drive will delay by Pr.05-25 before multi-function output terminals are active.

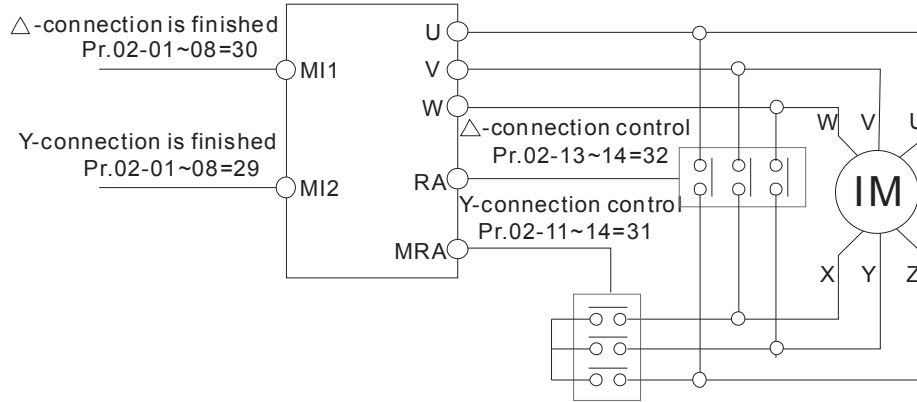

Y-Δ connection switch: can be used for wide range motor
 Y-connection for low speed: higher torque can be used for rigid tapping
 Δ-connection for high speed: higher torque can be used for high-speed drilling

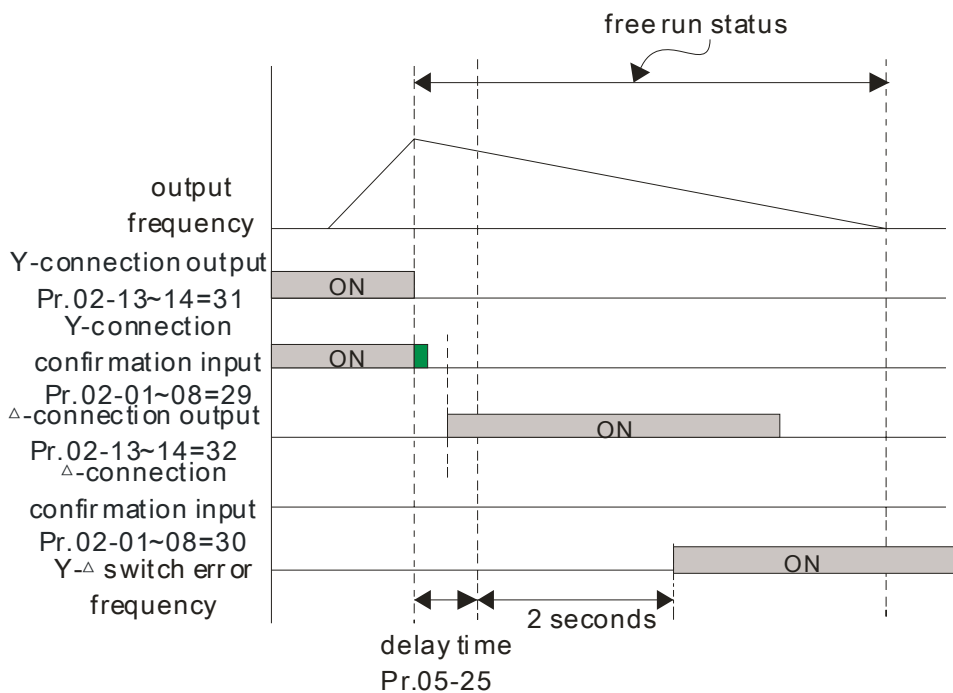
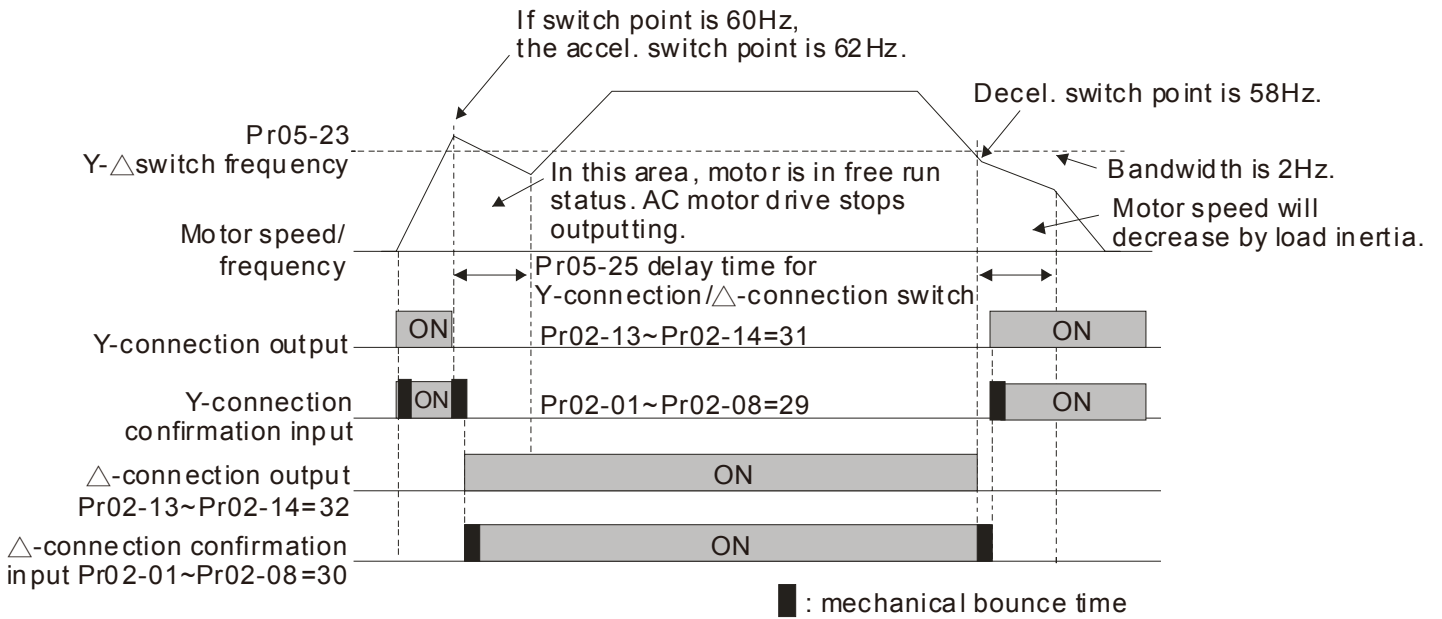

05-26 Reserved**05-27** Reserved**05-28** Motor drive's Accumulated Operating Watt per Hour (W-Hour)

Factory Setting: 0.0

Settings Read only

05-29 Motor drive's Accumulated Operating Kilowatt per Hour (KW-Hour)

Factory Setting: 0.0

Settings Read only

05-30 Motor Drive's Accumulated Operating Megawatt per Hour (MW-Hour)

Factory Setting: 0.0

Settings Read only

 Pr.05-26~05-29 records the amount of power consumed by motors. The accumulation begins when the drive is activated and record is saved when the drive stops or turns OFF. The amount of consumed watts will continue to accumulate when the drive activate again. To clear the accumulation, set Pr.00-02 to 5 then the accumulation record will return to 0.

 For example, set Pr05-28=400Wh, Pr05-29=150kWh, Pr05-30=76MWh. The total accumulated power is 76150.4kWh.

05-31 Accumulative Motor Operation Time (Min)

Factory Setting: 0

Settings 00~1439

05-32 Accumulative Motor Operation Time (day)

Factory Setting: 0

Settings 00~65535

 Pr. 05-31 and Pr.05-32 are used to record the motor operation time. To clear the operation time, set Pr.05-31 and Pr.05-32 to 00. Operation time shorter than 60 seconds will not be recorded.

05-33 Induction Motor (IM) and Permanent Magnet Motor Selection

Factory Setting: 0

Settings 0: Induction Motor
 1: Permanent Magnet Motor (SPM)
 2: Permanent Magnet Motor (IPM)

05-34 Full-load current of Permanent Magnet Motor

Factory Setting: 0.00

Settings 0.00~655.35 Amps

 Set this parameter in accord to motor's nameplate. Default setting is 90% motor drive rated current.

For example: 7.5HP (5.5kW) rated current is 25A, then Pr05-34 default is 22.5A

Setting range will be 10~30A (25*10%=2.5A 25*120%=30A)

↗ **05-35** Rated Power of Permanent Magnet Motor
 Factory Setting: 0.00
 Settings 0.00~655.35 kW

📖 Set motor rated power in accord to motor nameplate. Default setting is motor drive rated power.

↗ **05-36** Rated speed of Permanent Magnet Motor
 Factory Setting: 2000
 Settings 0~65535 rpm

05-37 Pole number of Permanent Magnet Motor
 Factory Setting: 10
 Settings 0~65535

05-38 Inertia of Permanent Magnet Motor
 Factory Setting: 0.0
 Settings 0.0~6553.5 kg.cm² (0.0001kg.m²)

📖 Default value will follow the chart

Rated Power (kW)	0.4	0.75	1.5	2.2	3.7	5.5	7.5	9.3	11
Rotor inertia (kg.cm ²)	1.2	3.0	6.6	15.8	25.7	49.6	82.0	121.6	177.0

Rated Power (kW)	14.1	18.2	27	33	40	46	54	Above 54
Rotor inertia (kg.cm ²)	211.0	265.0	308.0	527.0	866.0	1082.0	1267.6	1515.0

05-39 Stator Resistance of PM Motor
 Factory Setting: 0.000
 Settings 0.000~65.535Ω

05-40 Permanent Magnet Motor Ld
 Factory Setting: 0.00
 Settings 0.00~655.35 mH

05-41 Permanent Magnet Motor Lq
 Factory Setting: 0.00
 Settings 0.00~655.35 mH

↗ **05-42** PG Offset angle of PM Motor
 Factory Setting: 0.0
 Settings 0.0~360.0°

📖 When Pr.05-00 is set to 4, the drive will detect offset angle and write into Pr.05-42.

↗ **05-43** Ke parameter of PM Motor
 Unit: V/1000rpm
 Factory Setting: 0
 Settings 0~65535

06 Protection Parameters

↗ This parameter can be set during operation.

↗ 06-00 Low Voltage Level

Factory Setting: 360.0

Settings 300.0~440.0Vdc

- 📖 This parameter is used to set the Low Voltage level. When the DC BUS voltage is lower than Pr.06-00, drive will stop output and free to stop.
- 📖 If the drive is triggered LV fault during the operation, drive will stop output and free to stop. There are three LV faults, LvA (LV during acceleration), LvD (LV during deceleration), and LvN (LV in constant speed) which will be triggered in different stage of drive operation. These faults need to be reset manually to restart the drive, while setting restart after momentary power off function (Pr.07-06, Pr.07-07), the drive will restart automatically.
- 📖 If LV is triggered when the drive is in stop status, the fault is named LvS (LV during stop), which will not be recorded, and the drive will restart automatically when input voltage is 30Vdc (230V series) or 60Vdc (460V series) higher than LV level.

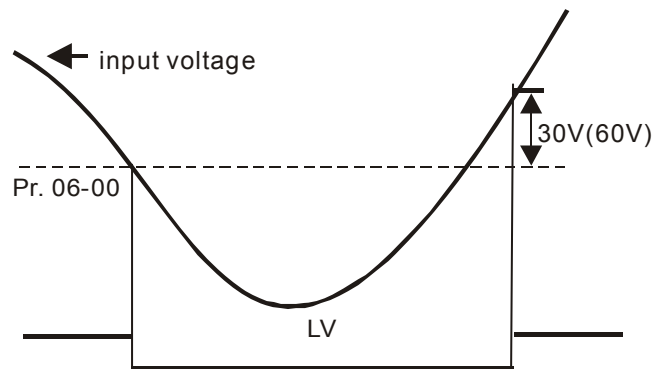

↗ 06-01 Over-voltage Stall Prevention

Factory Setting: 760.0

Settings 700.0~900.0V

0: Disabled

- 📖 When Pr.06-01 is set to 0.0, the over-voltage stall prevention function is disabled. When braking units or resistors are connected to the drive, this setting is suggested.
- 📖 When the setting is not 0.0, the over-voltage stall prevention is activated. This setting should refer to power supply system and loading. If the setting is too low, then over-voltage stall prevention will be easily activate, which may increase deceleration time.
- 📖 Related parameters: Pr.01-13, Pr.01-15, Pr.01-17, Pr.01-19 Decel. Time 1~4, Pr.02-13~Pr.02-15 Multiple-function output (Relay 1, 2 and 3) and Pr.06-02 selection for over-voltage stall prevention.

06-02 Selection for Over-voltage Stall Prevention

Factory Setting: 0

Settings 0: Traditional over-voltage stall prevention

1: Smart over-voltage prevention

- 📖 This function is used for the occasion that the load inertia is unsure. When it stops in the normal

load, the over-voltage won't occur during deceleration and fulfill the setting of deceleration time. Sometimes, it may not stop due to over-voltage during decelerating to stop when increasing the load regenerative inertia. At this moment, the AC drive will auto add the deceleration time until drive stop.

📖 Pr.06-02 is set to 0: During deceleration, the DC bus voltage may exceed its maximum allowable value due to motor regeneration in some situation, such as loading inertia is too high or decel. Time is set too short. When traditional over-voltage stall prevention is enabled, the drive will not decelerate further and keep the output frequency constant until the voltage drops below the setting value again.

📖 When Pr.06-02 is set to 1, the drive will maintain DCbus voltage when decelerating and prevent

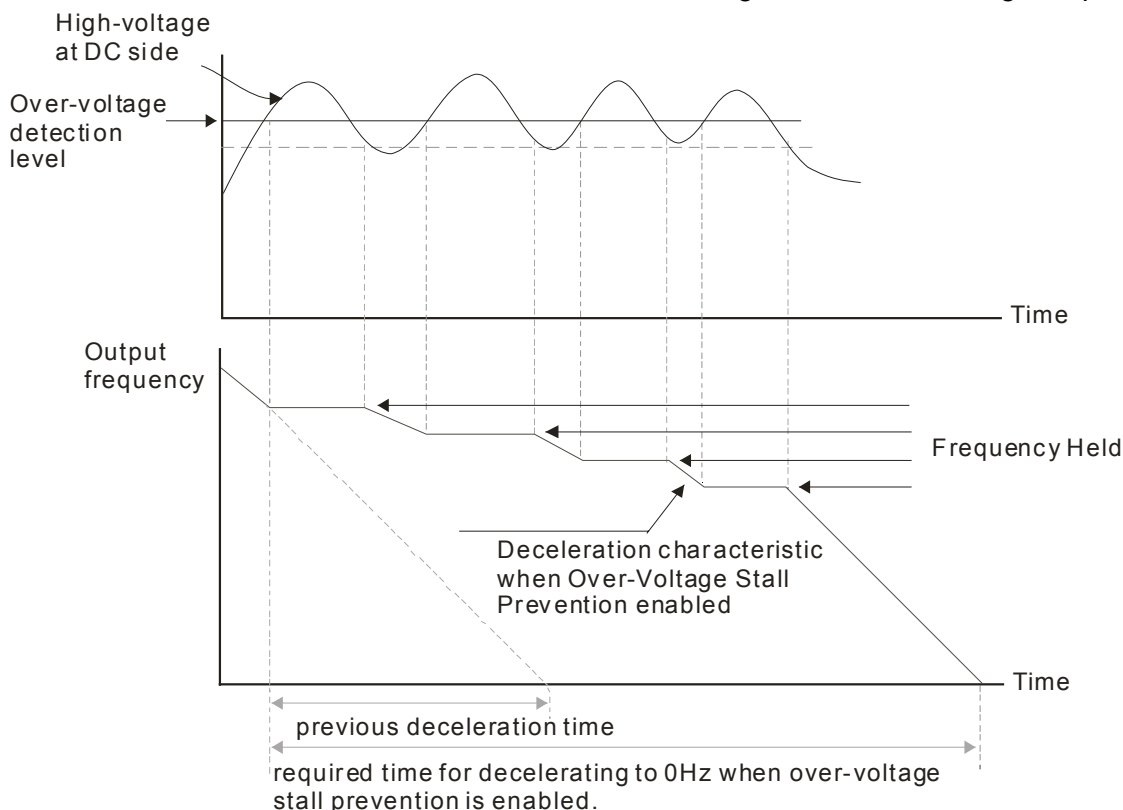

OV.

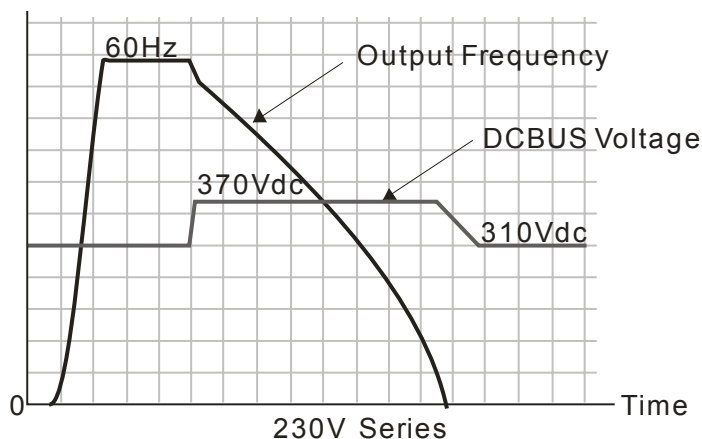

📖 When the over-voltage stall prevention is enabled, drive deceleration time will be larger than the setting.

📖 When there is any problem as using deceleration time, refer to the following items to solve it.

1. Add the suitable deceleration time.

2. Add brake resistor (refer to Chapter 7-1 for details) to dissipate the electrical energy that regenerated from the motor as heat type.

📖 Related parameters: Pr.01-13, Pr.01-15, Pr.01-17, Pr.01-19 Decel. Time 1~4, Pr.02-13~Pr.02-14 Multiple-function output (Relay 1 and 2), Pr.02-16~Pr.02-17 Multiple-function output (MO1,2), and Pr.06-01 over-voltage stall prevention.

➤ **06-03** Over-current Stall Prevention during Acceleration

Factory Setting: 120

Settings Normal duty: 0~160% (100%: drive's rated current)
Light duty: 0~130% (100%: drive's rated current)

- 📖 If the motor load is too large or drive acceleration time is too short, the AC drive output current may increase abruptly during acceleration and it may cause motor damage or trigger protection functions (OL or OC). This parameter is used to prevent this situation.
- 📖 During acceleration, the AC drive output current may increase abruptly and exceed the value specified by Pr.06-03 due to rapid acceleration or excessive load on the motor. When this function is enabled, the AC drive will stop accelerating and keep the output frequency constant until the current drops below the maximum value.
- 📖 When the over-current stall prevention is enabled, drive acceleration time will be larger than the setting.
- 📖 When the Over-Current Stall Prevention occurs due to too small motor capacity or in the factory setting, please decrease Pr.06-03 setting.
- 📖 When there is any problem by using acceleration time, refer to the following items to solve it.
- 📖 Related parameters: Pr.01-12, 01-14, 01-16, 01-18 (settings of accel. time 1~4), Pr.01-44
 1. Add the suitable acceleration time.
 2. Setting Pr.01-44 Optimal Acceleration/Deceleration Setting to 1, 3 or 4 (auto accel.)
 3. Optimal Acceleration/Deceleration Setting, Pr.02-13~02-15 (Multi-function Output 1 RY1, RY2, RY3).

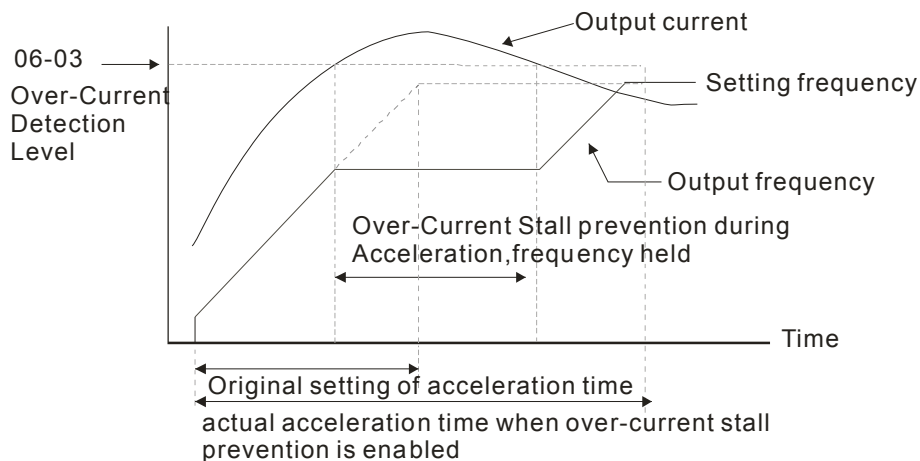

➤ **06-04** Over-current Stall Prevention during Operation

Factory Setting: 120

Settings Normal duty: 0~160% (100%: drive's rated current)
Light duty: 0~130% (100%: drive's rated current)

- 📖 It is a protection for drive to auto decrease output frequency when the motor is over-load abruptly

during motor constant operation.

- If the output current exceeds the setting specified in Pr.06-04 when the drive is operating, the drive will decrease its output frequency (according to Pr.06-05) to prevent the motor stall. If the output current is lower than the setting specified in Pr.06-04, the drive will accelerate (according to Pr.06-05) again to catch up with the set frequency command value.

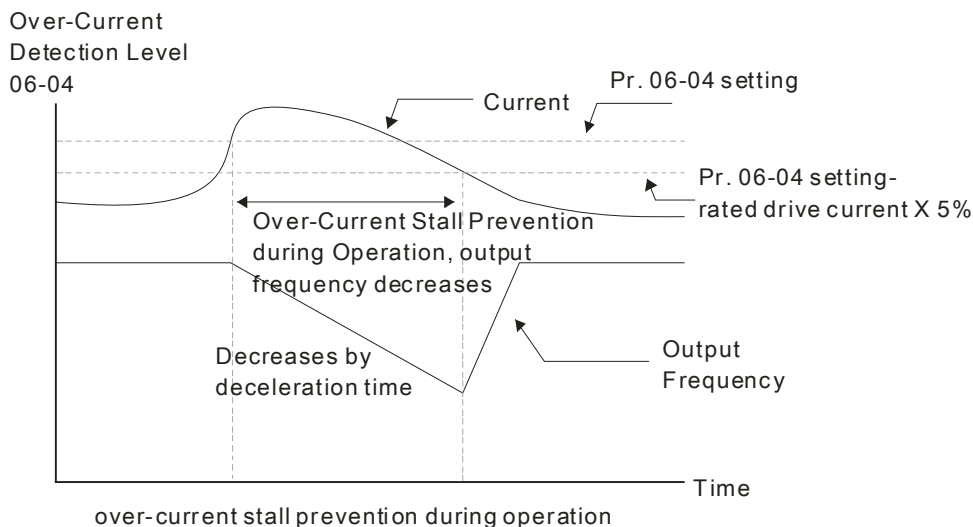

06-05 Accel./Decel. Time Selection of Stall Prevention at Constant Speed Factory Setting: 0

- Settings
- 0: by current accel/decel time
 - 1: by the 1st accel/decel time
 - 2: by the 2nd accel/decel time
 - 3: by the 3rd accel/decel time
 - 4: by the 4th accel/decel time
 - 5: by auto accel/decel

It is used to set the accel./decel. time selection when stall prevention occurs at constant speed.

06-06 Over-torque Detection Selection (OT1) Factory Setting: 0

- Settings
- 0: No function
 - 1: Continue operation after Over-torque detection during constant speed operation
 - 2: Stop after Over-torque detection during constant speed operation
 - 3: Continue operation after Over-torque detection during RUN
 - 4: Stop after Over-torque detection during RUN

06-09 Over-torque Detection Selection (OT2) Factory Setting: 0

- Settings
- 0: No function
 - 1: Continue operation after Over-torque detection during constant speed operation
 - 2: Stop after Over-torque detection during constant speed operation
 - 3: Continue operation after Over-torque detection during RUN

4: Stop after Over-torque detection during RUN

- 📖 When Pr.06-06 and Pr.06-09 are set to 1 or 3, it will display a warning message and won't have an abnormal record.
- 📖 When Pr.06-06 and Pr.06-09 are set to 2 or 4, it will display a warning message and will have an abnormal record.

↗ **06-07** Over-torque Detection Level (OT1) Factory Setting: 120

Settings 10 to 200% (100%: drive's rated current)

↗ **06-08** Over-torque Detection Level (OT1) Factory Setting: 0.1

Settings 0.1~60.0 sec

↗ **06-10** Over-torque Detection Level (OT2) Factory Setting: 120

Settings 10 to 200% (100%: drive's rated current)

↗ **06-11** Over-torque Detection Time (OT2) Factory Setting: 0.1

Settings 0.1~60.0 sec

- 📖 When the output current exceeds the over-torque detection level (Pr.06-07 or Pr.06-10) and also exceeds Pr.06-08 or Pr.06-11, the over torque detection will follow the setting of Pr.06-06 and Pr.06-09.
- 📖 When Pr.06-06 or Pr.06-09 is set to 1 or 3, the motor drive will have the ot1/ot2 warning after Over Torque Detection, while the motor drive will keep running. The warning will be off only until the output current is smaller than the 5% of the over-torque detection level (Pr.06-07 and Pr.06-10).

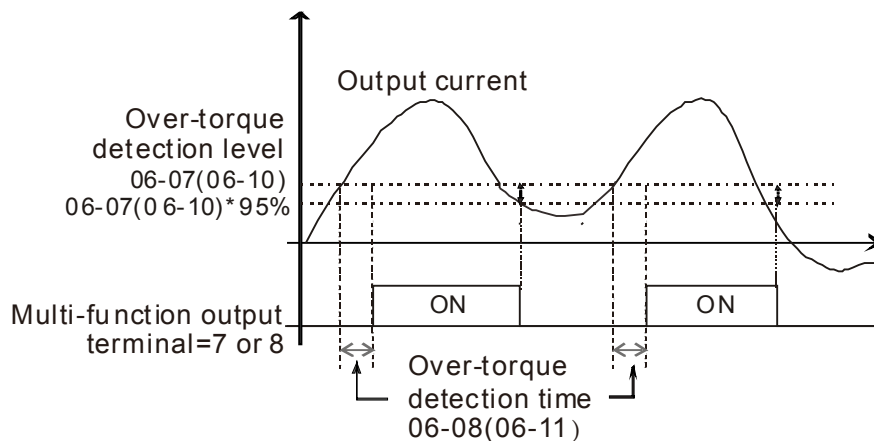

- 📖 When Pr.06-06 or Pr.06-09 is set to 2 or 4, the motor drive will have the ot1/ot2 fault after Over Torque Detection. Then the motor drive stop running until it is manually reset.

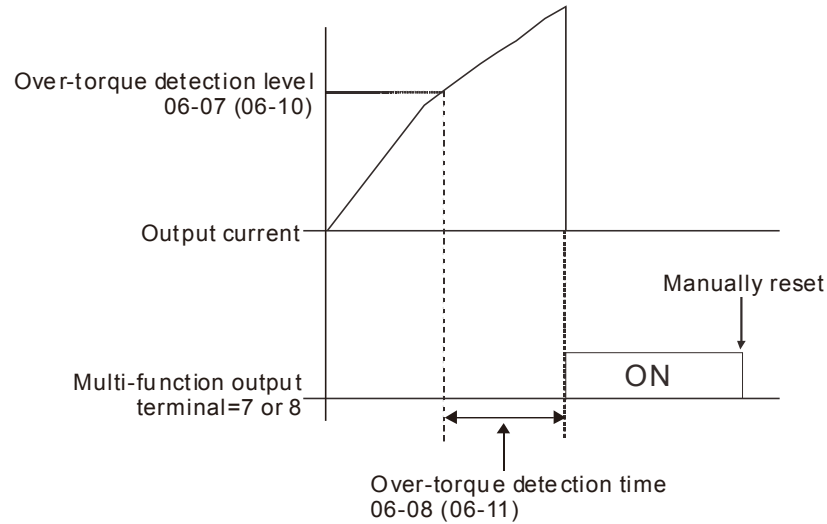

06-12 Current Limit

Factory Setting: 150

Settings 0~200% (100%: drive's rated current)

Pr.06-12 sets the maximum output current of the drive.

06-13 Electronic Thermal Relay Selection (Motor 1)

06-27 Electronic Thermal Relay Selection (Motor 2)

Factory Setting: 2

Settings 0: Inverter motor (with external forced cooling)

1: Standard motor (so motor with fan on the shaft)

2: Disable

It is used to prevent self-cooled motor overheats under low speed. User can use electronic thermal relay to limit driver's output power.

Setting as 0 is suitable for special motor (motor fan using independent power supply). For this kind of motor, the cooling capacity is not related to motor speed obviously. So the action of electronic thermal relay will remain stable in low speed, which can ensure the motor's load capability in low speed.

Setting as 1 is suitable for standard motor (motor fan is fixed on the rotor shaft). For this kind of motor, the cooling capacity is low in low speed, and the action of electronic thermal relay will reduce the action time, which ensure the life of motor.

When the power ON/OFF is often switched, even setting as 0 or 1 can not protect the motor well. It is because when the power is switched off, the electronic thermal relay protection will be reset. If there are several motors connected to one motor drive, please install electronic thermal relay in each motor respectively.

06-14 Electronic Thermal Characteristic for Motor 1

06-28 Electronic Thermal Characteristic for Motor 2

Factory Setting: 60.0

Settings 30.0~600.0 sec

The parameter is set by the 150% of motor rated current and the setting of Pr.06-14 and Pr.06-28 to prevent the motor damaged from overheating. When it reaches the setting, it will display

“EoL1/EoL2” and the motor will be in free running.

 This parameter is to set the action time of electronic thermal relay. It works based on the I2t characteristic curve of electronic thermal relay, output frequency and current of motor drive, and operation time to prevent motor from over-heat.

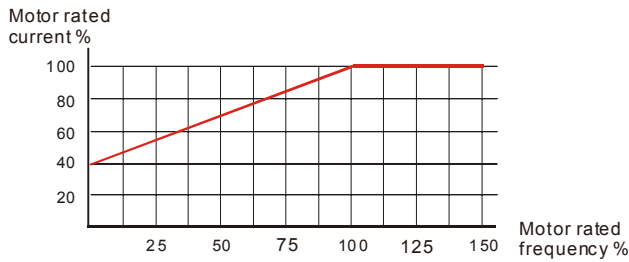

Motor cooling curve with shaft-fixed fan

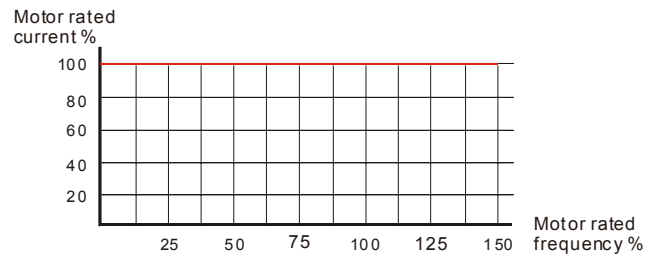

Motor cooling curve with independent fan

 The action of electronic thermal relay depends on the setting of Pr.06-13/Pr.06-27.

1. 06-13 or 06-27 is set 0 (using special motor) :

When output current of motor drive is higher than 150% of motor current (refer to motor cooling curve with independent fan), motor drive will start to count the time. When the accumulated time exceeds Pr.06-14 or 06-28, electronic thermal relay will act.

2. 06-13 or 06-27 is set 0 (using standard motor) :

When output current of motor drive is higher than 150% of motor current (refer to motor cooling curve with shaft-fixed fan), motor drive will start to count the time. When the accumulated time exceeds Pr.06-14 or 06-28, electronic thermal relay will act.

The real electronic thermal relay action time will adjust with drive output current (shown as motor loading rate). When the current is high, the action time is short; when the current is high, the action time is short. Please refer to following chart:

Operation time (sec.)

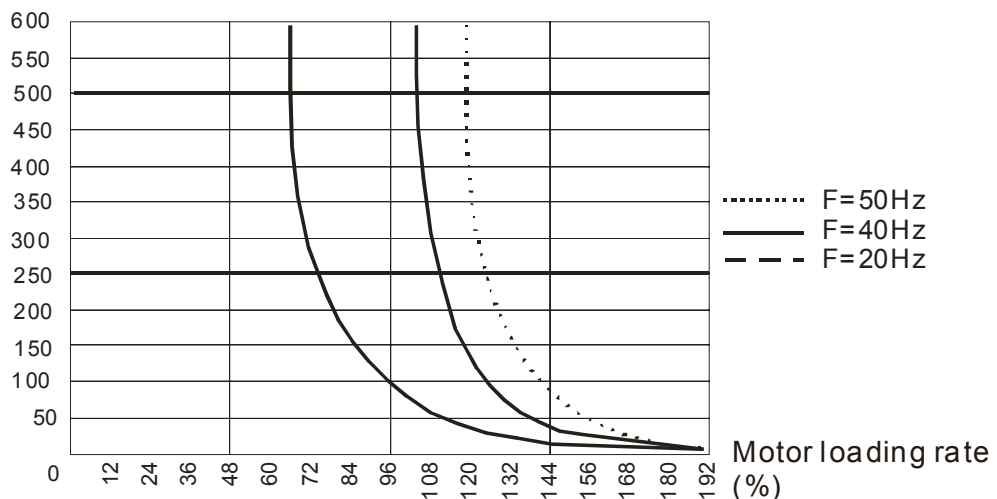

 **06-15** Heat Sink Over-heat (OH1) Warning

Factory Setting: 105.0

Settings 0.0~110.0°C

 When using heavy duty or advanced control mode, the OH warning will be disabled if Pr.06-15 remains as default. When the temperature reaches 100°C, motor drive will stop with IGBT over-heat fault.

When using normal duty or general control mode, the OH warning will be disabled if Pr06-15 is set to 110°C. When the temperature reaches 110°C, motor drive will stop with IGBT over-heat fault.

06-16 Stall Prevention Limit Level (Flux weakening area current stall prevention level)

Factory Setting: 50

Settings 0~100% (Refer to Pr.06-03, Pr.06-04)

When operation frequency is larger than Pr.01-01; e.g. Pr.06-03=150%, Pr.06-04=100% and Pr.06-16=80%:

Calculate the Stall Prevention Level during acceleration: Pr.06-03 * Pr.06-16=150x80%=120%.

Calculate the Stall Prevention Level at constant speed: Pr.06-04 * Pr.06-16=100x80%=80%.

06-17 Fault Record 1 (Present Fault Record)

06-18 Fault Record 2

06-19 Fault Record 3

06-20 Fault Record 4

06-21 Fault Record 5

06-22 Fault Record 6

Settings

0: No fault record

1: Over-current during acceleration (ocA)

2: Over-current during deceleration (ocd)

3: Over-current during constant speed(ocn)

4: Ground fault (GFF)

5: IGBT short-circuit (occ)

6: Over-current at stop (ocS)

7: Over-voltage during acceleration (ovA)

8: Over-voltage during deceleration (ovd)

9: Over-voltage during constant speed (ovn)

10: Over-voltage at stop (ovS)

11: Low-voltage during acceleration (LvA)

12: Low-voltage during deceleration (Lvd)

13: Low-voltage during constant speed (Lvn)

14: Stop mid-low voltage (LvS)

15: Phase loss protection (OrP)

16: IGBT over-heat (oH1)

17: Capacitance over-heat (oH2) (for 40hp above)

18: tH1o (TH1 open: IGBT over-heat protection error)

19: tH2o (TH2 open: capacitance over-heat protection error)

20: Reserved

21: Drive over-load (oL)

22: Electronics thermal relay 1 (EoL1)

23: Electronics thermal relay 2 (EoL2)

24: Motor PTC overheat (oH3) (PTC/PT100)

25: Reserved

26: Over-torque 1 (ot1)

27: Over-torque 2 (ot2)

28: Low current (uC)

29: Reserved

30: Memory write-in error (cF1)

- 31: Memory read-out error (cF2)
- 32: Reserved
- 33: U-phase current detection error (cd1)
- 34: V-phase current detection error (cd2)
- 35: W-phase current detection error (cd3)
- 36: Clamp current detection error (Hd0)
- 37: Over-current detection error (Hd1)
- 38: Over-voltage detection error (Hd2)
- 39: occ IGBT short circuit detection error (Hd3)
- 40: Auto tuning error (AUE)
- 41: PID feedback loss (AFE)
- 42~47: Reserved
- 48: Analog current input loss (ACE)
- 49: External fault input (EF)
- 50: Emergency stop (EF1)
- 51: External Base Block (bb)
- 52: Password error (Pcod)
- 53: Software code error
- 54: Communication error (CE1)
- 55: Communication error (CE2)
- 56: Communication error (CE3)
- 57: Communication error (CE4)
- 58: Communication Time-out (CE10)
- 59: Reserved
- 60: Brake transistor error (bF)
- 61: Y-connection/ Δ -connection switch error (ydc)
- 62: Decel. Energy Backup Error (dEb)
- 63: Slip error (oSL)
- 64: Electromagnet switch error (ryF)
- 65~71: Reserved
- 72: Channel 1 (STO1~SCM1) internal hardware error (STL1)
- 73: External safety gate S1
- 74: FIRE mode output
- 75: Reserved
- 76: Safety Torque Off (STO)
- 77: Channel 2 (STO2~SCM2) internal hardware error (STL2)
- 78: Channel 1 and Channel 2 internal hardware error (STL3)
- 79: U PHASE SHORT (Uocc)
- 80: V PHASE SHORT (Vocc)
- 81: W PHASE SHORT (Wocc)
- 82: OPHL U phase output phase loss
- 83: OPHL Vphase output phase loss
- 84: OPHL Wphase output phase loss
- 85~89: Reserved
- 90: Inner PLC function is forced to stop
- 91~98: Reserved
- 99: TRAP CPU command error
- 100: Reserved
- 101: CGdE CANopen software disconnect1
- 102: CHbE CANopen software disconnect2
- 103: CSyE CANopen synchronous error
- 104: CbFE CANopen hardware disconnect
- 105: CIdE CANopen index setting error
- 106: CAdE CANopen slave station number setting error
- 107: CFrE CANopen index setting exceed limit
- 108~110: Reserved
- 111: InrCOM Internal communication overtime error

 When the fault occurs and force stopping, it will record in this parameter.

 At stop with low voltage Lv (LvS warn, no record). During operation with mid-low voltage Lv (LvA,

Lvd, Lvn error, will record).

Setting 62: when dEb function is enabled, the drive will execute dEb and record to the Pr.06-17 to Pr.06-22 simultaneously.

↗	06-23	Fault Output Option 1
↗	06-24	Fault Output Option 2
↗	06-25	Fault Output Option 3
↗	06-26	Fault Output Option 4

Factory Setting: 0

Settings 0 to 65535 sec (refer to bit table for fault code)

These parameters can be used with multi-function output (set to 35-38) for the specific requirement. When the fault occurs, the corresponding terminals will be activated (It needs to convert binary value to decimal value to fill in Pr.06-23 to Pr.06-26).

Fault Code	Bit0	Bit1	Bit2	Bit3	Bit4	Bit5	Bit6
	current	Volt.	OL	SYS	FBK	EXI	CE
0: No fault							
1: Over-current during acceleration (ocA)	●						
2: Over-current during deceleration (ocd)	●						
3: Over-current during constant speed(ocn)	●						
4: Ground fault (GFF)	●						
5: IGBT short-circuit (occ)	●						
6: Over-current at stop (ocS)	●						
7: Over-voltage during acceleration (ovA)		●					
8: Over-voltage during deceleration (ovd)		●					
9: Over-voltage during constant speed (ovn)		●					
10: Over-voltage at stop (ovS)		●					
11: Low-voltage during acceleration (LvA)		●					
12: Low-voltage during deceleration (Lvd)		●					
13: Low-voltage during constant speed (Lvn)		●					
14: Stop mid-low voltage (LvS)		●					
15: Phase loss protection (OrP)		●					
16: IGBT over-heat (oH1)			●				
17: Capacitance over-heat (oH2)			●				
18: tH1o (TH1 open)			●				
19: tH2o (TH2 open)			●				
20: Reserved							
21: Drive over-load (oL)			●				
22: Electronics thermal relay 1 (EoL1)			●				
23: Electronics thermal relay 2 (EoL2)			●				
24: Motor PTC overheat (oH3) (PTC)			●				
25: Reserved							
26: Over-torque 1 (ot1)			●				
27: Over-torque 2 (ot2)			●				
28: Low current (uC)	●						
29: Reserved							
30: Memory write-in error (cF1)				●			

Fault Code	Bit0	Bit1	Bit2	Bit3	Bit4	Bit5	Bit6
	current	Volt.	OL	SYS	FBK	EXI	CE
31: Memory read-out error (cF2)				●			
32: Reserved							
33: U-phase current detection error (cd1)				●			
34: V-phase current detection error (cd2)				●			
35: W-phase current detection error (cd3)				●			
36: Clamp current detection error (Hd0)				●			
37: Over-current detection error (Hd1)				●			
38: Over-voltage detection error (Hd2)				●			
39: occ IGBT short circuit detection error (Hd3)				●			
40: Auto tuning error (AUE)				●			
41: PID feedback loss (AFE)					●		
42~47: Reserved							
43: PG feedback loss (PGF2)					●		
44: PG feedback stall (PGF3)					●		
45: PG slip error (PGF4)					●		
46: PG ref loss (PGr1)					●		
47: PG ref loss (PGr2)					●		
48: Analog current input loss (ACE)					●		
49: External fault input (EF)						●	
50: Emergency stop (EF1)						●	
51: External Base Block (bb)						●	
52: Password error (Pcod)				●			
53: Software code error				●			
54: Communication error (CE1)							●
55: Communication error (CE2)							●
56: Communication error (CE3)							●
57: Communication error (CE4)							●
58: Communication Time-out (CE10)							●
59: PU Time-out (CP10)							●
60: Brake transistor error (bF)						●	
61: Y-connection/ Δ -connection switch error (ydc)						●	
62: Decel. Energy Backup Error (dEb)		●					
63: Slip error (oSL)						●	
64: Electromagnet switch error (ryF)						●	
65~71: Reserved							
72: Channel 1 (STO1~SCM1) internal hardware error (STL1)				●			
73: External safety gate S1				●			
74: FIRE mode output						●	
75: Reserved							
76: Safety Torque Off (STO)				●			
77: Channel 2 (STO2~SCM2) internal hardware error (STL2)				●			
78: Channel 1 and Channel 2 internal hardware error (STL3)				●			

Fault Code	Bit0	Bit1	Bit2	Bit3	Bit4	Bit5	Bit6
	current	Volt.	OL	SYS	FBK	EXI	CE
79: U phase over current (Uocc)	●						
80: V phase over current (Vocc)	●						
81: W phase over current (Wocc)	●						
82: OPHL U phase output phase loss	●						
83: OPHL Vphase output phase loss	●						
84: OPHL Wphase output phase loss	●						
85~89: Reserved							
90: Inner PLC function is forced to stop							
91~98: Reserved							
99: TRAP CPU command error				●			
100: Reserved							
101: CGdE CANopen software disconnect1							●
102: CHbE CANopen software disconnect2							●
103: CSyE CANopen synchronous error							●
104: CbFE CANopen hardware disconnect							●
105: CIdE CANopen index setting error							●
106: CAde CANopen slave station number setting error							●
107: CFrE CANopen index setting exceed limit							●
108~110: Reserved							
111: InrCOM Internal communication overtime error							●

06-29 PTC (Positive Temperature Coefficient) Detection Selection

Factory Setting: 0

- Settings
- 0: Warn and keep operating
 - 1: Warn and ramp to stop
 - 2: Warn and coast to stop
 - 3: No warning

 Pr.06-29 setting defines how the will drive operate after PTC detection.

06-30 PTC Level

Factory Setting: 50.0

Settings 0.0~100.0%

 It needs to set AVI1/ACI/AVI2 analog input function Pr.03-00~03-02 to 6 (P.T.C. thermistor input value).

 It is used to set the PTC level, and the corresponding value for 100% is max. analog input value.

06-31 Frequency Command for Malfunction

Factory Setting: Read only

Settings 0.00~655.35Hz

 When malfunction occurs, use can check the frequency command. If it happens again, it will overwrite the previous record.

06-32 Output Frequency at Malfunction

Factory Setting: Read only

Settings 0.00~655.35Hz

 When malfunction occurs, user can check the current frequency command. If it happens again, it will overwrite the previous record.

06-33 Output Voltage at Malfunction

Factory Setting: Read only

Settings 0.0~6553.5V

 When malfunction occurs, user can check current output voltage. If it happens again, it will overwrite the previous record.

06-34 DC Voltage at Malfunction

Factory Setting: Read only

Settings 0.0~6553.5V

 When malfunction occurs, user can check the current DC voltage. If it happens again, it will overwrite the previous record.

06-35 Output Current at Malfunction

Factory Setting: Read only

Settings 0.0~6553.5Amp

 When malfunction occurs, user can check the current output current. If it happens again, it will overwrite the previous record.

06-36 IGBT Temperature at Malfunction

Factory Setting: Read only

Settings -3276.7~3276.7°C

 When malfunction occurs, user can check the current IGBT temperature. If it happens again, it will overwrite the previous record.

06-37 Capacitance Temperature at Malfunction

Factory Setting: Read only

Settings -3276.7~3276.7°C

 When malfunction occurs, user can check the current capacitance temperature. If it happens again, it will overwrite the previous record.

06-38 Motor Speed in rpm at Malfunction

Factory Setting: Read only

Settings -32767~32767 rpm

 When malfunction occurs, user can check the current motor speed in rpm. If it happens again, it will overwrite the previous record.

06-39 Reserved

06-40 Status of Multi-function Input Terminal at Malfunction

Factory Setting: Read only

Settings 0000h~FFFFh

06-41 Status of Multi-function Output Terminal at Malfunction

Factory Setting: Read only

Settings 0000h~FFFFh

When malfunction occurs, user can check the status of multi-function input/output terminals. If it happens again, it will overwrite the previous record.

06-42 Drive Status at Malfunction

Factory Setting: Read only

Settings 0000H~FFFFh

When malfunction occurs, please check the drive status (communication address 2119H). If malfunction happens again, the previous record will be overwritten by this parameter.

06-43 Reserved✎ **06-44** STO Alarm Latch

Factory Setting: 0

Settings 0: STO alarm Latch
1: STO alarm no Latch

Pr.06-44=0 STO Alarm Latch: after the reason of STO Alarm is cleared, a Reset command is need to clear STO Alarm.

Pr.06-44=1 STO Alarm no Latch: after the reason of STO Alarm is cleared, the STO Alarm will be cleared automatically.

All of STL1~STL3 error are "Alarm latch" mode (in STL1~STL3 mode, the Pr.06-44 function is no effective).

✎ **06-45** Treatment to Output Phase Loss (OPHL)

Factory Setting: 3

Settings 0: Warn and keep operating
1: Warn and ramp to stop
2: Warn and coast to stop
3: No warning

The OPHL protect will be active when the setting is not 3.

✎ **06-46** Deceleration Time of Output Phase Loss

Factory Setting:0.500

Settings 0.000~65.535 sec

✎ **06-47** Current detection level of output phase loss

Factory Setting:1.00

Settings 0.00~100.00%

➤ **06-48** Output phase loss detection function executing time before run

Factory Setting:0.000

Settings 0.000~65.535 sec

📖 When Pr.06-48 is 0, OPHL detection function will be disabled

📖 Status 1 : Motor drive is in operation

Any phase is less than Pr.06-47 setting level, and exceeds Pr.06-46 setting time, motor drive will perform Pr.06-45 setting.

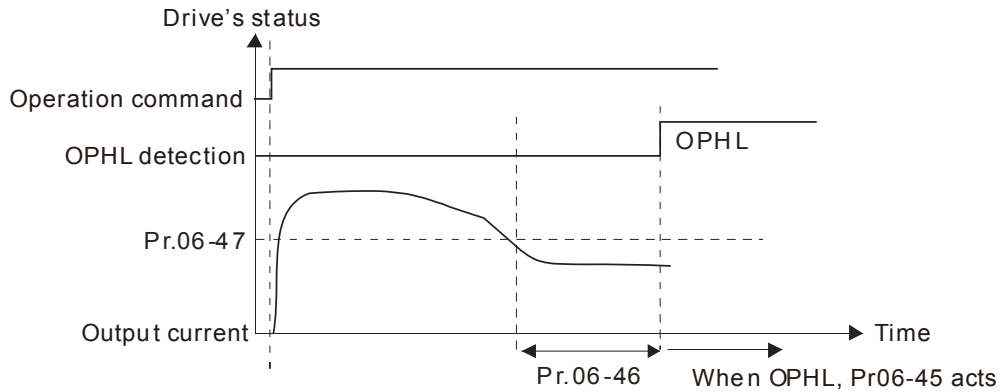

📖 Status 2 : Motor drive is in stop; Pr.06-48=0 ; Pr.07-02 ≠ 0

After motor drive starts, DC brake will be applied in accord to Pr.07-01 and Pr.07-02. During this period, OPHL detection will not be conducted. After DC brake, motor drive starts to run, and conducts the OPHL protection as mentioned in status 1.

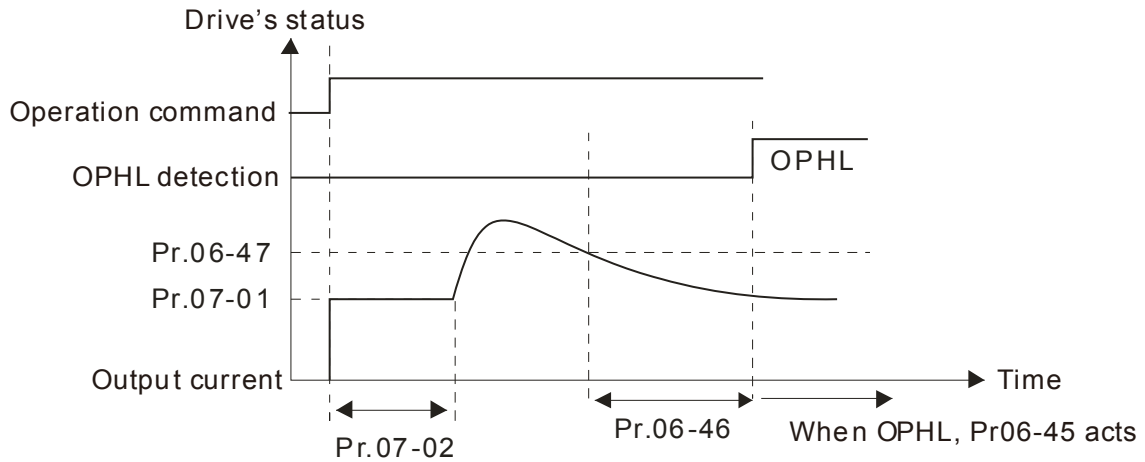

📖 Status 3: Motor drive is in stop; Pr.06-48 ≠ 0 ; Pr.07-02 ≠ 0

When motor drive starts, it will perform Pr.06-48 and then Pr.07-02 (DC brake). DC brake current level in this status includes two parts, one is 20 times of Pr.06-47 setting value in Pr.06-48 setting time, and Pr.07-02 setting value in Pr.07-01 setting time. Total DC brake time is $T=Pr.06-48+Pr.07-02$.

In this period, if OPHL happens, motor drive starts to count Pr.06-48/2 time, motor drive will perform Pr.06-45 setting.

Status 3-1: Pr06-48 ≠ 0, Pr07-02 ≠ 0 (No OPHL detected before operation)

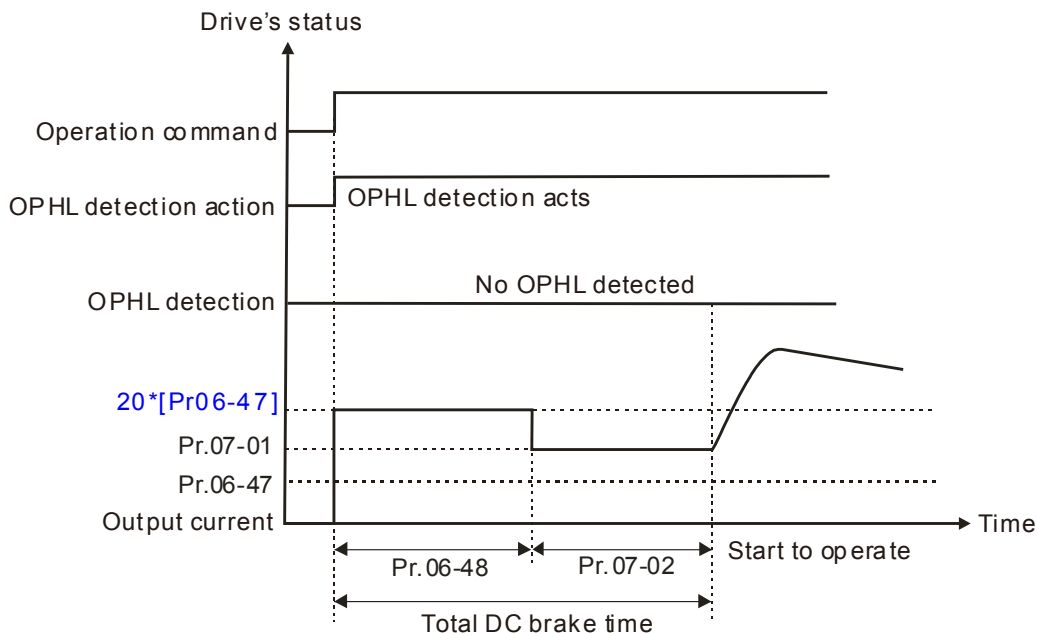

Status 3-2: Pr06-48 ≠ 0, Pr07-02 ≠ 0 (OPHL detected before operation)

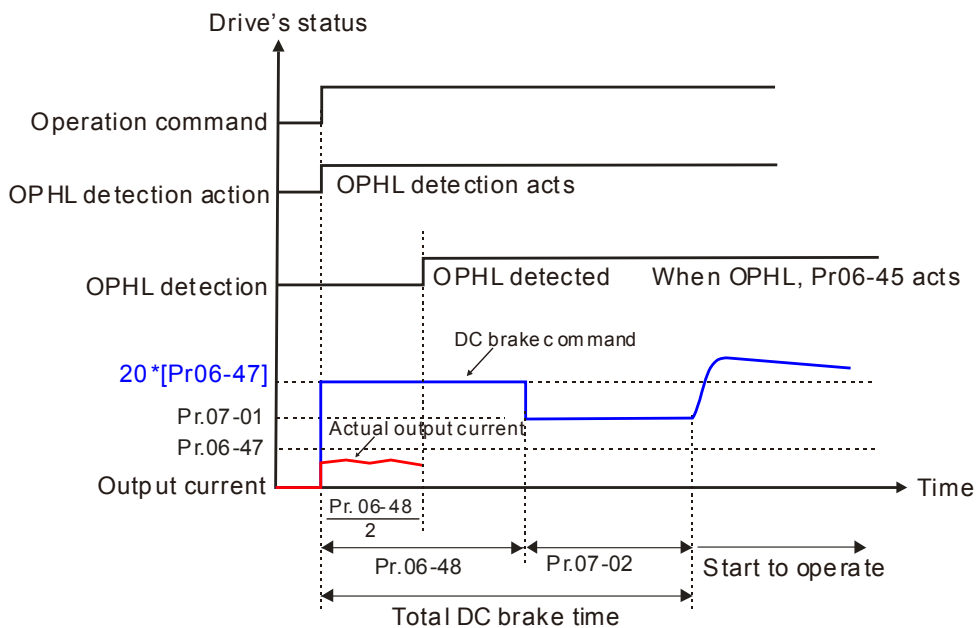

Status 4: Motor drive is in stop; Pr.06-48 ≠ 0 ; Pr.07-02=0

When motor drive starts, it will perform Pr.06-48 as DC brake. The DC brake current level is 20 times of Pr.06-47 setting value. In this period, if OPHL happens, motor drive starts to count Pr.06-48/2 time, motor drive will perform Pr.06-45 setting.

Status 4-1: Pr06-48 ≠ 0, Pr07-02=0 (No OPHL detected before operation)

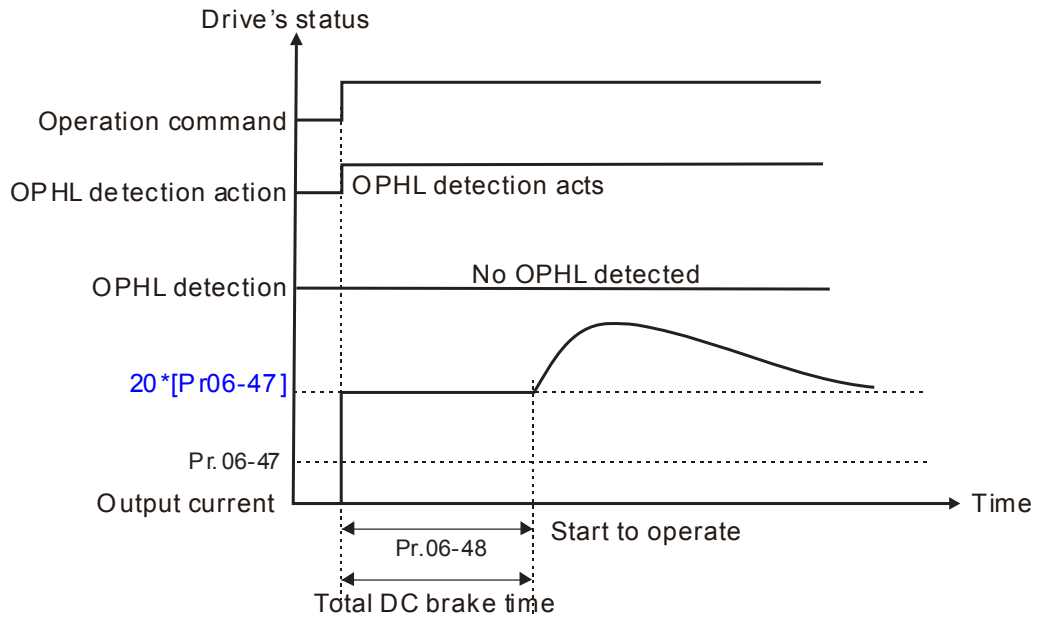

Status 4-2: Pr06-48 ≠ 0, Pr07-02=0 (OPHL detected before operation)

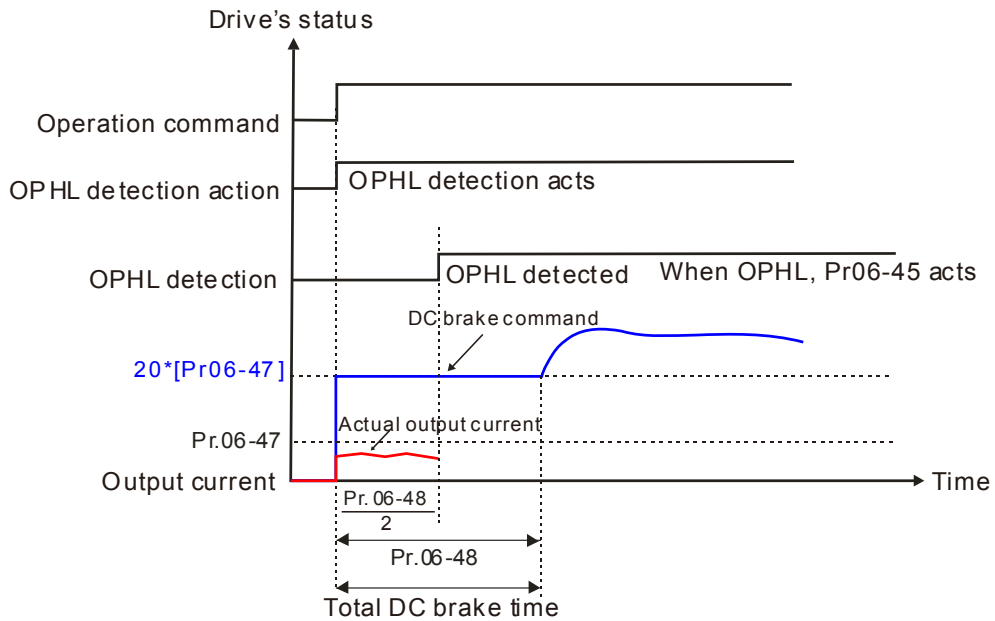

06-49 LvX Auto Reset

Factory Setting: 0

Settings 0: Disable
1: Enable

06-50 Time for Input Phase Loss Detection

Factory Setting: 0.20

Settings 0.00~600.00 sec

06-51 Reserved

06-52 Ripple of Input Phase Loss

Factory Setting: 60.0

Settings 0.0~320.0 Vdc

- 📖 When the DC BUS ripple is higher than Pr.06-52, and continue Pr.06-50 plus 30 seconds, drive will trip up OrP and act depending on the setting of Pr.06-53 to stop.
- 📖 In the time period Pr.06-50 plus 30 seconds, if the DC BUS ripple is lower than Pr.06-52, the OrP protection counter will be restart.

06-53 Treatment for the detected Input Phase Loss (OrP)

Factory Setting: 0

Settings 0: warn, ramp to stop
1: warn, coast to stop

- 📖 We can get DC BUS ripple voltage via Pr.06-50 ripple time · when the condition is satisfy, drive will according to Pr.06-53 settings:
 - ◆ DC BUS ripple frequency $\leq 166\text{Hz}$ ·
 - ◆ The amplitude is higher than Pr.06-52 settings (default 60V), it will start to count time after 20 consecutive times.
 - ◆ When continue the following conditions at the time, ORP will occur. °

(I) % is rated current percentage

(I) %	Actual seconds
50	432
75	225
120	60

- 📖 When any condition is not satisfied, the ORP protect function will be recalculated.

06-54 Fault Code Record Index

Factory Setting: read only

Settings 0~6

06-55 Derating Protection

Factory Setting: 0

Settings 0: constant rated current and limit carrier wave by load current and temperature
1: constant carrier frequency and limit load current by setting carrier wave
2: constant rated current(same as setting 0), but close current limit

📖 Setting 0:

When the rated current is constant, carrier frequency (F_c) outputted by PWM will auto decrease according to surrounding temperature, overload output current and time. If overload situation is not frequent and only cares the carrier frequency operated with the rated current for a long time and carrier wave changes during short overload, it is recommended to set to 0.

Refer to the following diagram for the level of carrier frequency. Take VFD007C43A in normal duty as example, surrounding temperature 50°C with independent installation and UL open-type. When the carrier frequency is set to 15kHz, it corresponds to 72% rated output

current. When it outputs higher than the value, it will auto decrease the carrier frequency. If the output is 83% rated current and the carrier frequency will decrease to 12kHz. In addition, it will also decrease the carrier frequency when overload. When the carrier frequency is 15kHz and the current is $120\% \times 72\% = 86\%$ for a minute, the carrier frequency will decrease to the factory setting.

Setting 1:

It is used for the fixed carrier frequency and prevents the carrier wave changes and motor noise caused by the surrounding temperature and frequent overload.

Refer to the following for the derating level of rated current. Take VFD007C43A in normal duty as example, when the carrier frequency keeps in 15kHz and the rated current is decreased to 72%, it will have OL protection when the current is $120\% \times 72\% = 86\%$ for a minute. Therefore, it needs to operate by the curve to keep the carrier frequency.

Setting 2:

It sets the protection method and action to 0 and disables the current limit for the Ratio*160% of output current in the normal duty and Ratio*180% of output current in the heavy duty. The advantage is that it can provide higher output current when the setting is higher than the factory setting of carrier frequency. The disadvantage is that it decreases carrier wave easily when overload.

It should be used with Pr.00-16 and Pr.00-17 for setting.

Ambient temperature will also affect the derating, please refer to ambient temperature derating curve.

Ambient Temperature derating Curve for General Control Model

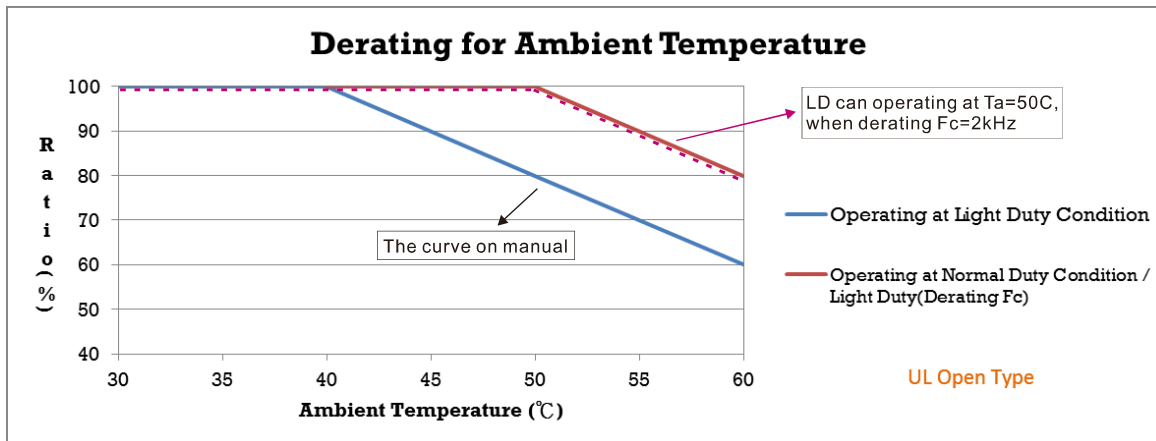
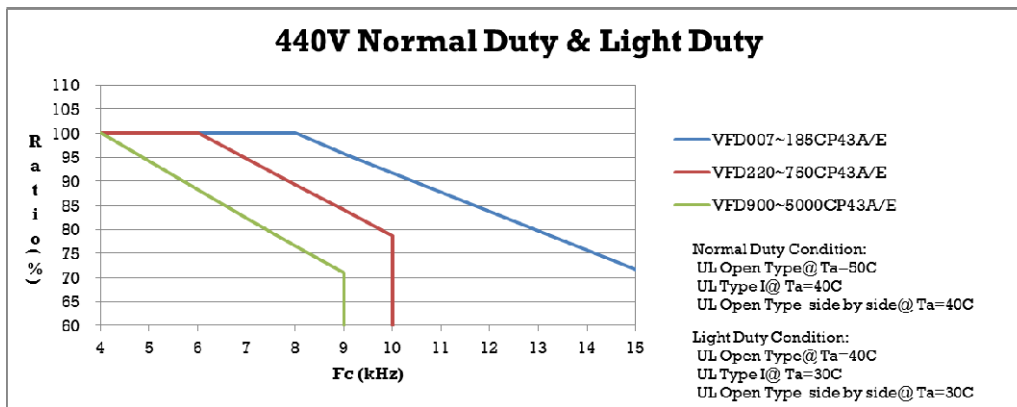

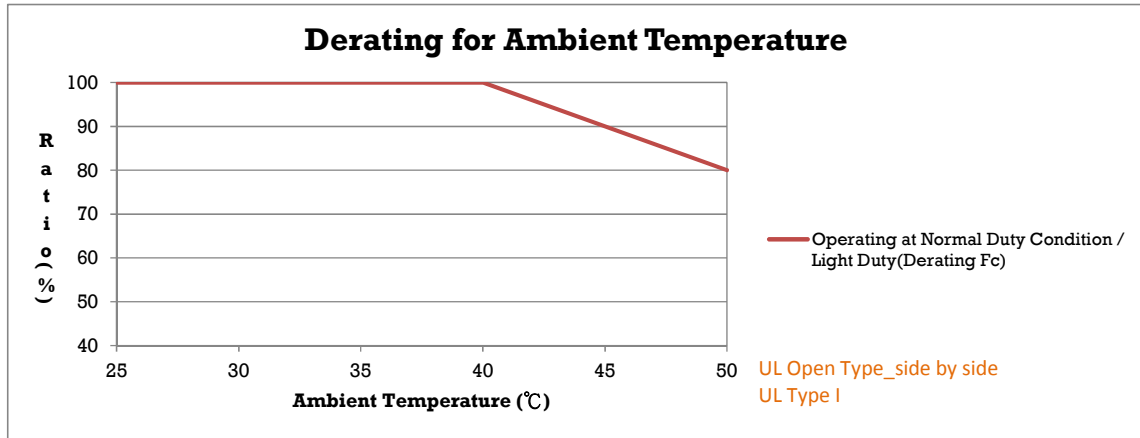

↗ **06-56** PT100 Detection Level 1

Factory Setting: 5.000

Settings 0.000~10.000V

↗ **06-57** PT100 Detection Level 2

Factory Setting: 7.000

Settings 0.000~10.000V

📖 Make sure Pr. 06-57 > Pr.06-56.

↗ **06-58** PT100 Level 1 Frequency Protection

Factory Setting: 0.00

Settings 0.00~599.00 Hz

↗ **06-59** PT100 activation level delay time

Factory Setting: 60 sec

Settings 0~6000 sec

📖 PT100 operation

- (1) Use AVI1, AVI2 or ACI(set to 0-10V) for analog voltage input and select PT100 mode.
- (2) Choose one of the analog voltage input type: (a)AVI 1(Pr.03-00=11), (b) AVI2 (Pr.03-02=11), or (c) ACI (Pr.03-01=11 and Pr.03-29=1).
- (3) When using ACI as analog voltage input, set Pr.03-01=11 and Pr.03-29=1. Then switch SW2 to 0-10V on the I/O control terminal block.
- (4) Set Pr.03-23=23 and AFM2 to constant current output. Switch AFM2 (SW2) to 0-20mA on the I/O control terminal block and set constant current output to 9mA by setting Pr.03-33=45. The AFM2 constant output current is $20\text{mA} * 45\% = 9\text{mA}$.
- (5) Pr.03-33 is for adjusting the constant voltage or constant current of AFM2, the setting range is 0~100.00%.
- (6) There are two types of action level for PT100. The diagram of PT protecting action is shown as below:

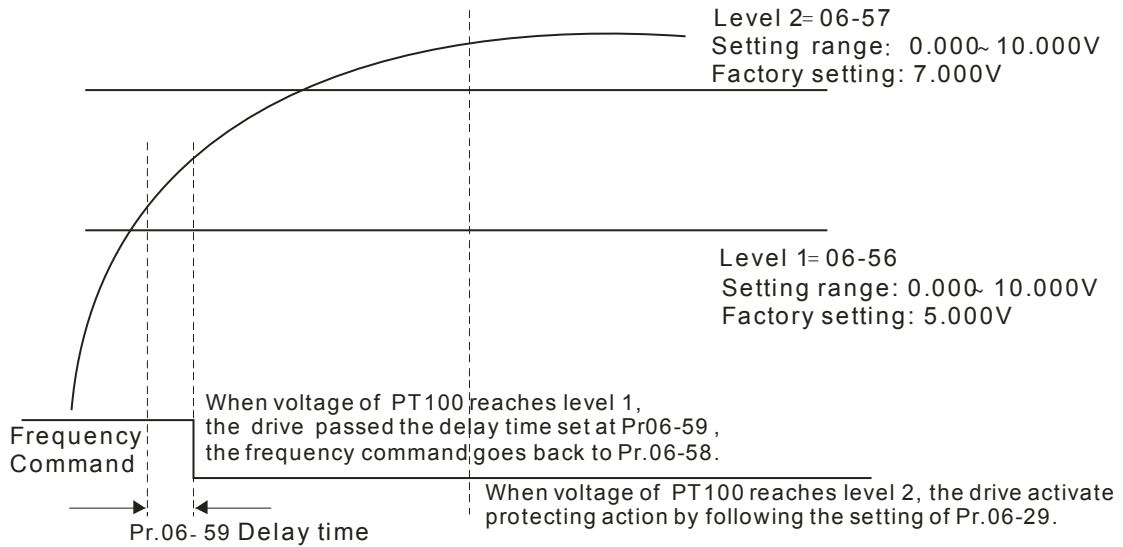

(7) PT100 wiring diagram:

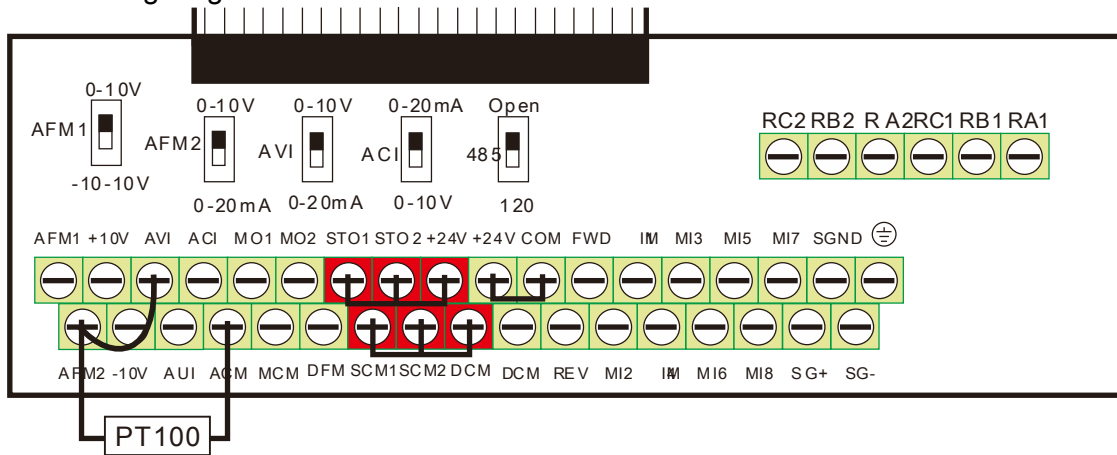

Figure 1

When Pr.06-58=0.00Hz, PT100 function is disabled.

Example:

A PT100 is installed to the drive. If motor temperature reaches 135°C (275°F) or higher, the drive will decrease motor frequency to the setting of Pr.06-58. Motor will operate at this frequency (Pr.06-58) till the motor temperature decreases to 135°C (275°F) or lower. If motor temperature exceeds 150°C (302°F), the motor will decelerate to stop and outputs an 'OH3' warning.

Set up process:

1. Switch AFM2 (SW2) to 0-20mA on the I/O control terminal block. (Refer to Figure 1, PT100 wiring diagram)
2. Wiring (Refer to Figure 1, PT100 wiring diagram):
 Connect external terminal AFM2 to (+)
 Connect external terminal ACM to (-)
 Connect external terminals AFM2 and AVI to short-circuit
3. Set Pr.03-00=11 or Pr.03-23=23 or Pr.03-33=45%(9mA)
4. Refer to RTD temperature and resistance comparison table
 Temperature=135°C, resistance=151.71Ω; Input current: 9mA, Voltage: approximately: 1.37Vdc
 Temperature=150°C, resistance=157.33Ω; Input current:9mA, Voltage: approximately: 1.42Vdc
5. Set Pr.06=56=1.37 and Pr.06-58=10Hz. When RTD temperature increases to 135°C or higher, the drive will decelerate to the selected frequency. When Pr.06-58=0, the drive will not run.

6. Set Pr.06-57=1.42 and Pr.06-29=1 (warning and decelerate to stop). When RTD temperature increases to 150°C or higher, the drive will decelerate to stop and outputs an 'OH3' warning.

↗ **06-60** Software Detection GFF Current Level

Factory Setting: 60.0

Settings 0.0~6553.5 %

↗ **06-61** Software Detection GFF Filter Time

Factory Setting: 0.10

Settings 0.00~655.35 sec

📖 When the motor drive detects the unbalanced three-phase out current is higher than the setting of Pr.06-60, GFF protection will be activated. Then the motor drive will stop outputting.

📖 When 3-phase current output unbalance value has exceeds Pr.06-60 setting, drive will trip up GFF and stop output immediately.

06-62 Reserved

06-63 Fault Record 1 (day)

06-65 Fault Record 2 (day)

06-67 Fault Record 3 (day)

06-69 Fault Record 4 (day)

Factory Setting: Read only

Settings 0~65535 days

06-64 Fault Record 1 (min)

06-66 Fault Record 2 (min)

06-68 Fault Record 3 (min)

06-70 Fault Record 4 (min)

Factory Setting: Read only

Settings 0~1439 min

📖 When there is any malfunctions in motor drive operation, Pr.06-17~22 will record 6 malfunctions recently, and Pr.06-63~70 can record the operation time for 4 malfunctions in sequence. It can help to check if there is any wrong with the drive according to the recorded internal time.

For example: The first error: ocA occurs in 1000 minutes after motor drive start operation. The second error: ocd happens after another 1000 minutes. The 4th error: ocA happens after another 1000 minutes. Then, the 5th error is ocd, happening 1000 minutes following 4th error. Last, 6th error ocn happens 1000 minutes after 5th error.

Then Pr.06-17~Pr.06-22 and Pr.06-63~Pr.06-70 will be:

	1 st fault	2 nd fault	3 rd fault	4 th fault	5 th fault	6 th fault
06-17	ocA	ocd	ocn	ocA	ocd	ocn
06-18	0	ocA	ocd	ocn	ocA	ocd
06-19	0	0	ocA	ocd	ocn	ocA
06-20	0	0	0	ocA	ocd	ocn

06-21	0	0	0	0	ocA	ocd
06-22	0	0	0	0	0	ocA
06-63	1000	560	120	1120	680	240
06-64	0	1	2	2	3	4
06-65	0	1000	560	120	1120	680
06-66	0	0	1	2	2	3
06-67	0	0	1000	560	120	1120
06-68	0	0	0	1	2	2
06-69	0	0	0	1000	560	120
06-70	0	0	0	0	1	2

※ From time record, it can be known that the last fault (Pr.06-17) happened after the drive run for 4days and 240 minutes.

↗ **06-71** Low Current Setting Level

Factory Setting: 0.0

Settings 0.0 ~ 100.0 %

↗ **06-72** Low Current Detection Time

Factory Setting: 0.00

Settings 0.00 ~ 360.00 sec

↗ **06-73** Treatment for low current

Factory Setting: 0

Settings 0 : No function
 1 : warn and coast to stop
 2 : warn and ramp to stop by 2nd deceleration time
 3 : warn and operation continue

📖 The drive will operate as the setting of Pr.06-73 when output current is lower than the setting of Pr.06-71 and when low current continues for a period longer than the setting of Pr.06-72. This parameter can also be used with external multi-function output terminal 44 (MO44) for low current output.

📖 The low current detection function will not be executed when drive is at sleep or standby status.

06-74 Reserved

06-75 Reserved

↗ **06-76** dEb motion offset setting

Factory Setting: 40.0

Settings 0.00 ~ 200.0V

06-77 ~ Reserved

06-79

06-80 Fire Mode

Factory Setting: 0.00

Settings 0: No Function
 1: Forward Operation
 2: Reverse Operation

 This parameter needs to work with multi-input function terminal #58 or #59 and multi-output function terminal #53 and #54.

Setting is 0: Fire mode is disabled

Setting is 1: When there is a fire, motors will operate clockwise (U, V,W).

Setting is 2: When there is a fire, motors will operate counter-clockwise.

06-81 Operating Frequency when running Fire Mode

Factory Setting: 60.00

Settings 0.00 ~ 599.00 Hz

 This parameter is to set up the drive's frequency when the fire mode is enabled.

06-82 Enable Bypass on Fire Mode

Factory Setting: 0.

Settings 0: Disable Bypass
 1: Enable Bypass

06-83 Bypass Delay Time on Fire Mode

Factory Setting: 0.0

Settings 0.00 ~ 6550.0 seconds

06-84 Number of Times of Unusual Reset at Fire Mode

Factory Setting: 0

Settings 0 ~ 10

06-85 Length of Time of Unusual Reset

Factory Setting: 60.0

Settings 0.00 ~ 6000.0sec

 The settings of Pr.06-82 to Pr.06-85 decide if switch motors to operating under mains electricity. Diagram of Bypass function's Sequence

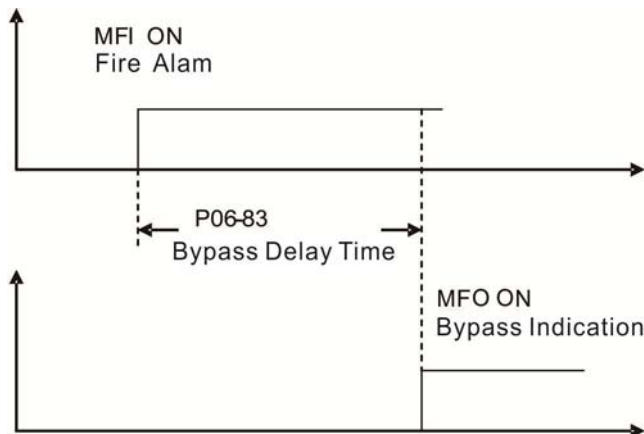

Figure: Activation Sequence of Bypass Function

Conditions is required to enable the bypass function

When Pr.06-82 is set to 1, there is one of two conditions as below.

- (1) When operating at fire mode, there is error (as shown in the table below) and the fire alarm rings according to the time setting of Pr.06-83, then the bypass function will be enabled. MFO bypass indication will be ON.
- (2) When operating at fire mode, there is an error on auto-reset and the number of time to auto-reset remains zero or the fire alarm rings according to the time setting of Pr.06-83, then the bypass function will be enabled. MFO bypass indication will be ON. If the auto rest is successful before the bypass function is enabled, then the bypass delay counter will return to zero to wait for next trigger.

Table 1: Error detection under Normal mode, Fire mode and Bypass function at Fire mode. (V means detectable)

Code	Error name	Normal mode	Fire Mode	Enable bypass function
1	Over current during Acceleration (ocA)	V(RS)	V(able to auto-reset)	V
2	Over current during deceleration (ocd)	V(RS)	V(able to auto-reset)	V
3	Over current during normal speed (ocn)	V(RS)	V(able to auto-reset)	V
4	Ground Fault (GFF)	V	V(able to auto-reset)	V
5	IGBT short circuit (occ)	V(RS)	V(able to auto-reset)	V
6	Over current during Stop (ocS)	V(RS)	V(able to auto-reset)	V
7	Over voltage during Acceleration (ovA)	V(RS)	V(able to auto-reset)	V
8	Over voltage during deceleration (ovd)	V(RS)	V(able to auto-reset)	V
9	Over voltage during normal speed (ovn)	V(RS)	V(able to auto-reset)	V
10	Over voltage during Stop (ovS)	V(RS)	V(able to auto-reset)	V
11	Low voltage during Acceleration (LvA)	V	Not-detectable	Not-detectable
12	Low voltage during deceleration (Lvd)	V	Not-detectable	Not-detectable
13	Low voltage during normal speed (Lvn)	V	Not-detectable	Not-detectable
14	Low voltage during Stop (LvS)	V	Not-detectable	Not-detectable
15	Input phase loss (OrP)	V	V(able to auto-reset)	V
16	Over heat 1 (oH1)	V	V(able to auto-reset)	V
17	Over heat 2 (oH2)	V	V(able to auto-reset)	V
18	Thermister 1 open (tH1o)	V	V(able to auto-reset)	V
19	Thermister 2 open (tH2o)	V	V(able to auto-reset)	V

Code	Error name	Normal mode	Fire Mode	Enable bypass function
21	Over Load (oL) (150% 1Min, Inverter)	V	Not-detectable	Not-detectable
22	Motor 1 over load (EoL1)	V	Not-detectable	Not-detectable
23	Motor 2 over load (EoL2)	V	Not-detectable	Not-detectable
24	Over heat 3 (oH3) (PTC)	V	V(able to auto-reset)	V
26	Over torque 1 (ot1)	V	Not-detectable	Not-detectable
27	Over torque 2 (ot2)	V	Not-detectable	Not-detectable
30	EEPROM write error (cF1)	V	Not-detectable	Not-detectable
31	EEPROM read error (cF2)	V	V	Not-detectable
33	U phase current sensor detection error (cd1)	V	V	Not-detectable
34	V phase current sensor detection error (cd2)	V	V	Not-detectable
35	W phase current sensor detection error (cd3)	V	V	Not-detectable
36	Hardware Logic error 0 (Hd0) - cc	V	V	Not-detectable
37	Hardware Logic error 1 (Hd1) - oc	V	V	Not-detectable
38	Hardware Logic error 2 (Hd2) - ov	V	V	Not-detectable
39	Hardware Logic error 3 (Hd3) – occ	V	V	Not-detectable
40	Motor auto tuning error (AuE)	V	Not-detectable	Not-detectable
41	ACI feedback loss (AFE)	V	Not-detectable	Not-detectable
48	ACI Loss	V	Not-detectable	Not-detectable
49	External fault (EF)	V	Not-detectable	Not-detectable
50	Emergency stop (EF1)	V	Not-detectable	Not-detectable
51	base block (bb)	V	Not-detectable	Not-detectable
52	PcodE (Password)	V	Not-detectable	Not-detectable
53	Software code error	V	V	Not-detectable
54	Communication error 1 (cE1)	V	Not-detectable	Not-detectable
55	Communication error 2 (cE2)	V	Not-detectable	Not-detectable
56	Communication error 3 (cE3)	V	Not-detectable	Not-detectable
57	Communication error 4 (cE4)	V	Not-detectable	Not-detectable
58	cE10 (Communication Time Out)	V	Not-detectable	Not-detectable
59	Communication time out (cP10)	V	Not-detectable	Not-detectable
60	Braking Transistor Fault (bf)	V	Not-detectable	Not-detectable
61	Y-Delta connected Error (ydc)	V	Not-detectable	Not-detectable
62	Decel. Energy Backup Error (dEb)	V	Not-detectable	Not-detectable
63	Over Slip Error (oSL)	V	Not-detectable	Not-detectable
64	Electromagnet switch error (ryF)	V	Not-detectable	Not-detectable
72	Channel 1 (STO1~SCM1) internal hardware error (STL1)	V	Not-detectable	Not-detectable
73	External safety gate S1	V	V	Not-detectable

Code	Error name	Normal mode	Fire Mode	Enable bypass function
74	Fire Mode output	V	V(keeps on operating)	V(keeps on operating)
76	Safety Torque Off (STO)	V	Not-detectable	Not-detectable
77	Channel 2 (STO2~SCM2) internal hardware error (STL2)	V	Not-detectable	Not-detectable
78	Channel 1 and Channel 2 internal hardware error (STL3)	V	Not-detectable	Not-detectable
79	U phase over current (Uocc)	V	V(able to auto-reset)	V
80	V phase over current (Vocc)	V	V(able to auto-reset)	V
81	W phase over current (Wocc)	V	V(able to auto-reset)	V
82	OPHL U phase output phase loss	V	V(able to auto-reset)	V
83	OPHL Vphase output phase loss	V	V(able to auto-reset)	V
84	OPHL Wphase output phase loss	V	V(able to auto-reset)	V
90	Inner PLC function is forced to stop	V	Not-detectable	Not-detectable
99	CPU Trap error	V	V	Not-detectable
101	CGdE CANopen software disconnect1	V	Not-detectable	Not-detectable
102	CHbE CANopen software disconnect2	V	Not-detectable	Not-detectable
103	CSYE CANopen synchronous error	V	Not-detectable	Not-detectable
104	CbFE CANopen hardware disconnect	V	Not-detectable	Not-detectable
105	CIdE CANopen index setting error	V	Not-detectable	Not-detectable
106	CAdE CANopen slave station number setting error	V	Not-detectable	Not-detectable
107	CFrE CANopen index setting exceed limit	V	Not-detectable	Not-detectable
111	InrCOM Internal communication overtime error	V	Not-detectable	Not-detectable

06-86**Fire mode motion**

Factory Setting: 0

- Settings 0: Open loop control & manual reset fire mode
 1: Close loop control & manual reset fire mode
 2: Open loop control & auto reset fire mode
 3: Close loop control & auto reset fire mode

06-87**Fire mode PID set point**

Factory Setting: 0.0

- Settings 0~100.00% (according to Pr.01-00 Max. operation frequency)

07 Special Parameters

✎ This parameter can be set during operation.

✎ 07-00 Software Brake Level

Factory Setting: 740.0

Settings 700.0~900.0Vdc

📖 This parameter sets the DC-bus voltage at which the brake chopper is activated. Users can choose the suitable brake resistor to have the best deceleration. Refer to Chapter 7 Accessories for the information of the brake resistor.

📖 It is only valid for the models below 30kW of 460 series.

✎ 07-01 DC Brake Current Level

Factory Setting: 0

Settings 0~100%

📖 This parameter sets the level of DC Brake Current output to the motor during start-up and stopping. When setting DC Brake Current, the Rated Current is regarded as 100%. It is recommended to start with a low DC Brake Current Level and then increase until proper holding torque has been attained.

✎ 07-02 DC Brake Time at RUN

Factory Setting: 0.0

Settings 0.0~60.0 sec

📖 The motor may be in the rotation status due to external force or itself inertia. If the drive is used with the motor at this moment, it may cause motor damage or drive protection due to over current. This parameter can be used to output DC current before motor operation to stop the motor and get a stable start. This parameter determines the duration of the DC Brake current after a RUN command. When it is set to 0.0, it is invalid.

✎ 07-03 DC Brake Time at Stop

Factory Setting: 0.0

Settings 0.0~60.0 sec

📖 The motor may be in the rotation status after drive stop outputting due to external force or itself inertia and can't stop accurately. This parameter can output DC current to force the motor drive stop after drive stops to make sure that the motor is stop.

📖 This parameter determines the duration of the DC Brake current during stopping. To DC brake at stop, this function will be valid when Pr.00-22 is set to 0 or 2. When setting to 0.0, it is invalid.

📖 Related parameters: Pr.00-22 Stop Method, Pr.07-04 Start-point for DC Brake

✎ 07-04 DC Brake Frequency at STOP

Factory Setting: 0.00

Settings 0.00~599.00Hz

📖 This parameter determines the frequency when DC Brake will begin during deceleration. When this setting is less than start frequency (Pr.01-09), the start-point for DC brake will start from the min. frequency.

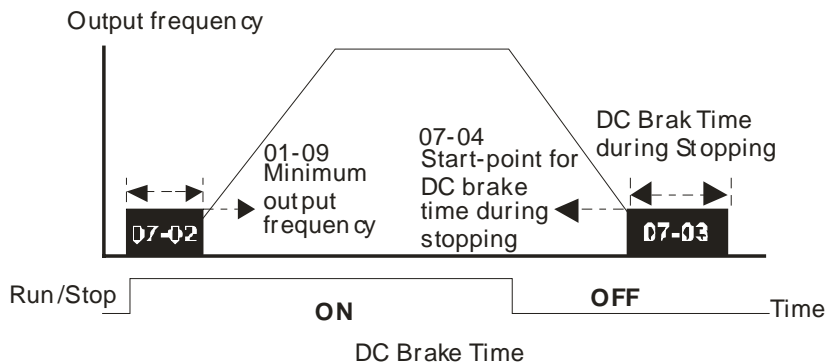

- 📖 DC Brake at Start-up is used for loads that may move before the AC drive starts, such as fans and pumps. Under such circumstances, DC Brake can be used to hold the load in position before setting it in motion.
- 📖 DC Brake at stop is used to shorten the stopping time and also to hold a stopped load in position, such as crane or cutting machine.

➤ **07-05** Voltage Increasing Gain

Factory Setting: 100

Settings 1~200%

- 📖 When the user is using speed tracking, adjust Pr07-05 to slow down the increasing of voltage if there are errors such as oL or oc.

➤ **07-06** Restart after Momentary Power Loss

Factory Setting: 0

- Settings
- 0: Stop operation
 - 1: Speed search for last frequency command
 - 2: Speed search for the minimum output frequency

- 📖 This parameter determines the operation mode when the AC motor drive restarts from a momentary power loss.
- 📖 The power connected to the drive may power off momentarily due to many reasons. This function allows the drive to keep outputting after power is on again after power off and won't cause drive stops.
- 📖 Setting 1: Operation continues after momentary power loss, speed search starts with the Master Frequency reference value after drive output frequency and motor rotator speed is synchronous. The motor has the characteristics of big inertia and small obstruction. For example, in the equipment with big inertia wheel, it doesn't need to wait to execute operation command until wheel is complete stop after re-start to save time.
- 📖 Setting 2: Operation continues after momentary power loss, speed search starts with the minimum output frequency after drive output frequency and motor rotator speed is synchronous. The motor has the characteristics of small inertia and bigger obstruction.

➤ **07-07** Maximum Power Loss Duration

Factory Setting: 2.0

Settings 0.1~20.0 sec

- 📖 If the duration of a power loss is less than this parameter setting, the AC motor drive will resume

operation. If it exceeds the Maximum Allowable Power Loss Time, the AC motor drive output is then turned off (coast stop).

The selected operation after power loss in Pr.07-06 is only executed when the maximum allowable power loss time is ≤ 5 seconds and the AC motor drive displays “LU”.

But if the AC motor drive is powered off due to overload, even if the maximum allowable power loss time is ≤ 5 seconds, the operation mode as set in Pr.07-06 is not executed. In that case it starts up normally.

07-08 Base block Time

Factory Setting: 0.5

Settings 0.0~5.0 sec

Pr 07-08 Factory Setting:

KW	007	015	022	037	040	055	075	110	150
HP	1	2	3	5	5.5	7.5	10	15	20
Pr07-08 (sec)	0.3	0.4	0.5	0.6	0.7	0.7	0.8	0.9	1

KW	185	220	300	370	450	550	750	900
HP	25	30	40	50	60	75	100	125
Pr07-08 (sec)	1.1	1.2	1.3	1.4	1.5	1.6	1.7	1.8

When momentary power loss is detected, the AC drive will block its output and then wait for a specified period of time (determined by Pr.07-08, called Base-Block Time) before resuming operation. This parameter should be set at a value to ensure that any residual regeneration voltage from the motor on the output has disappeared before the drive is activated again.

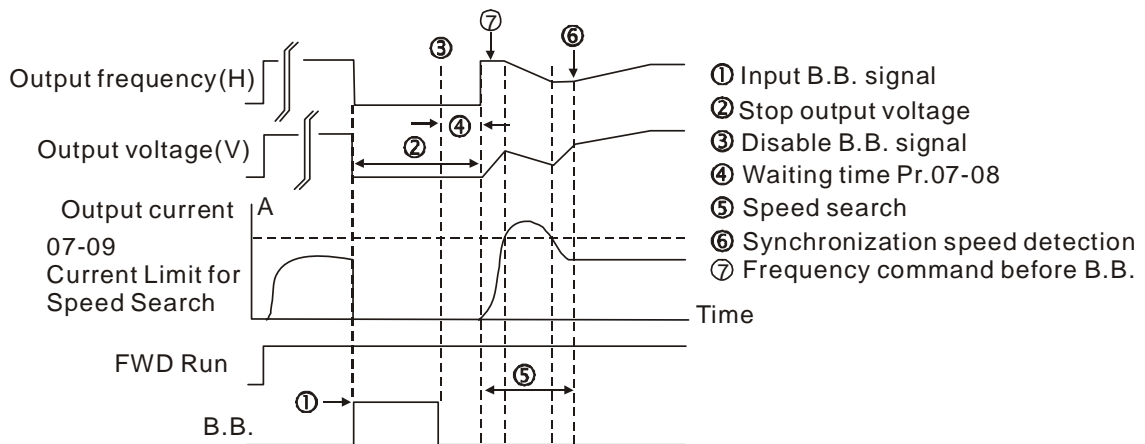

B.B. Search with last output frequency downward timing chart

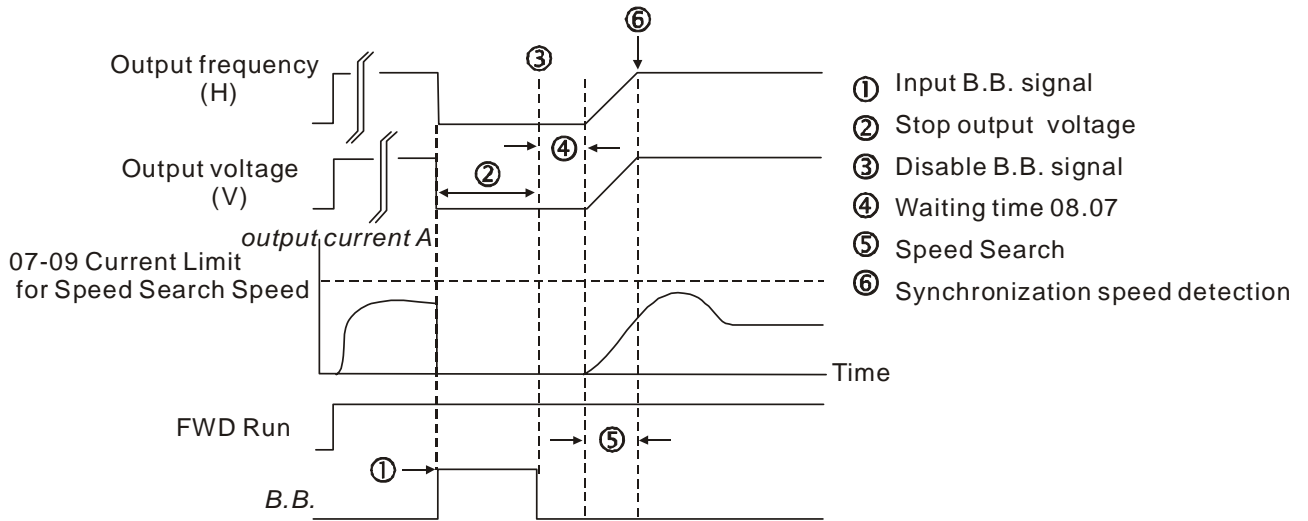

B.B. Search with minimum output frequency upward timing chart

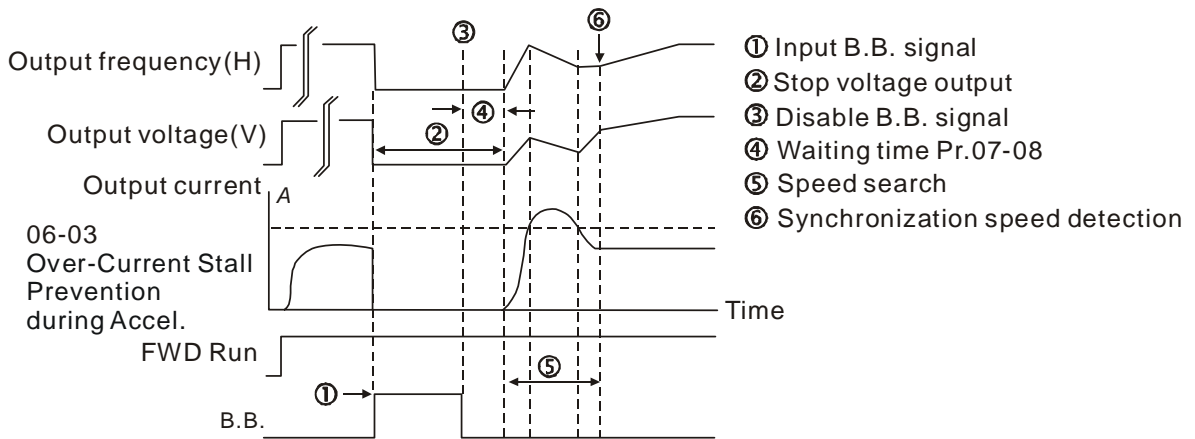

B.B. Search with minimum output frequency upward timing chart

✎ **07-09** Current Limit for Speed Search

Factory Setting: 100

Settings 20~200%

- 📖 Following a momentary power loss, the AC motor drive will start its speed search operation only if the output current is greater than the value set by Pr.07-09.
- 📖 When executing speed search, the V/f curve is operated by group 1 setting. The maximum current for the optimum accel./decel. and start speed search is set by Pr.07-09.
- 📖 The maximum speed search level will affect the synchronous time. It will get the synchronization faster when this parameter is set to larger value. But too large value may activate overload protection.

✎ **07-10** Treatment after Fault

Factory Setting: 0



- Settings
- 0: Stop operation
 - 1: Speed search starts with current speed
 - 2: Speed search starts with minimum output frequency

📖 Fault includes: bb,oc,ov,occ. To restart after oc, ov, occ, Pr.07-11 can not be set to 0.

07-11 Auto Restart Time after Fault

Factory Setting: 0

Settings 0~10

-  After fault (oc, ov, occ) occurs, the AC motor drive can be reset/restarted automatically up to 10 times.
-  Setting this parameter to 0 will disable the reset/restart operation after any fault has occurred. When enabled, the AC motor drive will restart with Pr07-10 setting after fault auto reset.
-  If the time of reset/restart exceeds Pr.07-11 setting, the fault will not be restart /reset until user reset manually and run the motor drive again.

07-12 Speed Search during Start-up

Factory Setting: 0

Settings 0: Disable

- 1: Speed search from maximum output frequency
- 2: Speed search from start-up motor frequency
- 3: Speed search from minimum output frequency

-  This parameter is used for starting and stopping a motor with a high inertia. A motor with high inertia will take 2-5 minutes or longer to stop completely. By setting this parameter, the user does not need to wait for the motor to come to a complete stop before restarting the AC motor drive. The output current is set by the Pr.07-09.

07-13 dEb Function Selection

Factory Setting: 0

Settings 0: Disable

- 1: dEb with auto accel./decal., the output frequency will not return after power reply.
- 2: dEb with auto accel./decal., the output frequency will return after power reply

-  This function is the AC motor drive decelerates to stop after momentary power loss. When the momentary power loss occurs, this function can be used for the motor to decelerate to zero speed with deceleration stop method. When the power is on again, motor will run again after DEB return time. (has applied on high-speed spindle)

Status 1: Insufficient power supply due to momentary power-loss/unstable power (due to low voltage)/sudden heavy-load

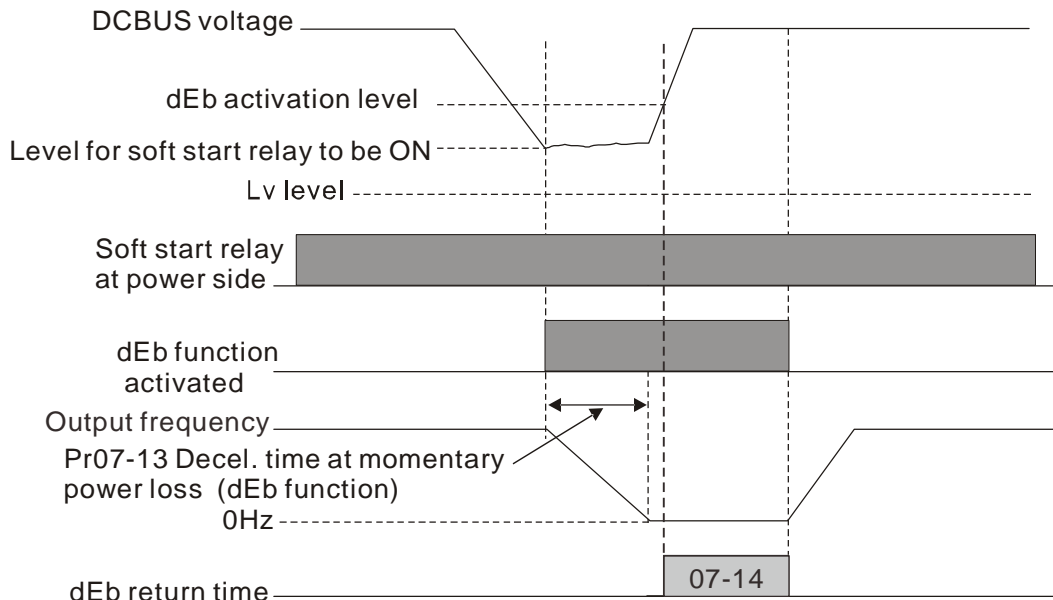

Note (1) When Pr.07-14 is set to 0, the motor drive will stop and will not accelerate to the frequency before dEb even the power is on again. But when Pr07-14 is NOT set to 0, then a command of zero speed will be sent to wait for power on.

Note (2) dEb activation level is when DCBUS voltage level lower than (230V series : Lv level +20Vdc)
(460V series: Lv level +40Vdc)

Status 2: unexpected power off, such as momentary power loss

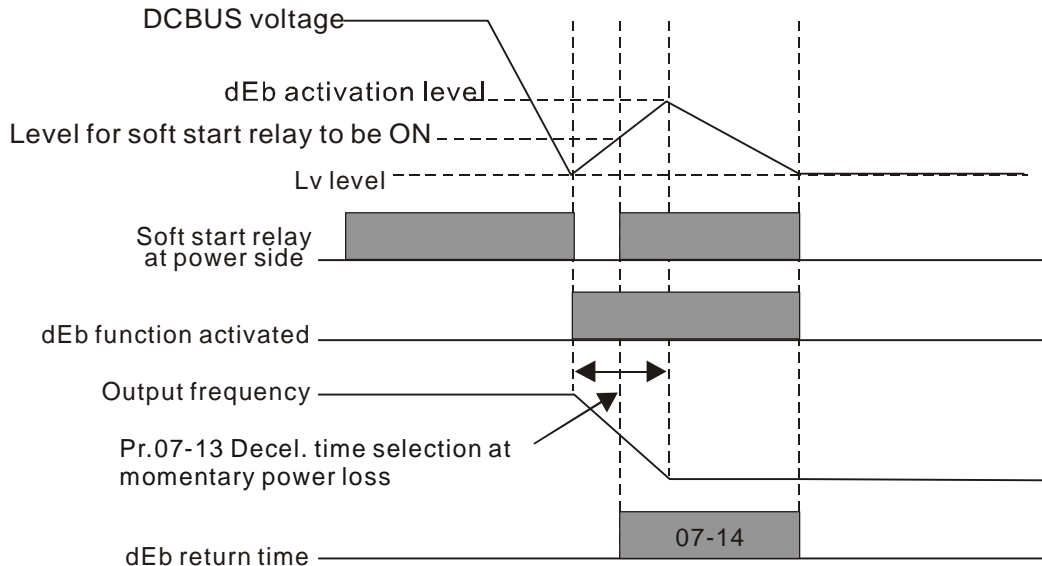

NOTE

For example, in textile machinery, you will hope that all the machines can be decelerated to stop to prevent broken stitching when power loss. In this case, the host controller will send a message to the AC motor drive to use dEb function with deceleration time via EF.

⚡ **07-14** Reserved

⚡ **07-15** Dwell Time at Accel.

Factory Setting: 0.00

Settings 0.00~600.00 sec

↗ **07-16** Dwell Frequency at Accel.

Factory Setting: 0.00

Settings 0.00~599.00Hz

↗ **07-17** Dwell Time at Decel.

Factory Setting: 0.00

Settings 0.00~600.00 sec

↗ **07-18** Dwell Frequency at Decel.

Factory Setting: 0.00

Settings 0.00~599.00 Hz

📖 In the heavy load situation, Dwell can make stable output frequency temporarily, such as crane or elevator.

📖 Pr.07-15 to Pr.07-18 is for heavy load to prevent OV or OC occurs.

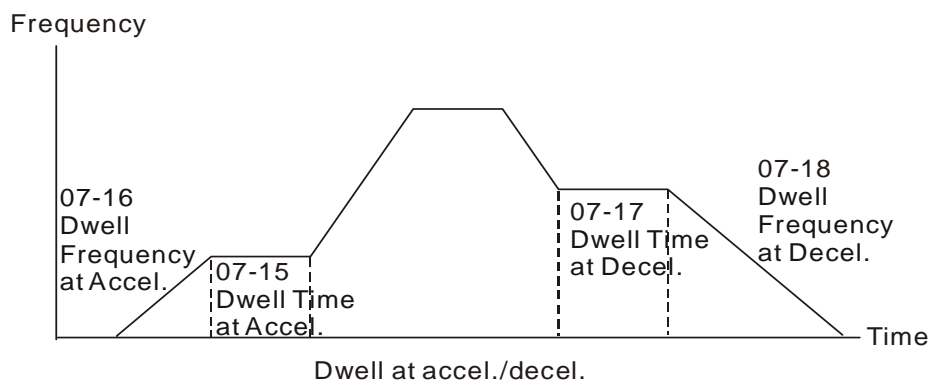

↗ **07-19** Fan Cooling Control

Factory Setting: 0

Settings 0: Fan always ON

1: 1 minute after the AC motor drive stops, fan will be OFF

2: When the AC motor drive runs, the fan is ON. When the AC motor drive stops, the fan is OFF

3: Fan turns ON when preliminary IGBT temperature (around 60°C) is attained.

4: Fan always OFF

📖 This parameter is used for the fan control.

📖 Setting 0: Fan will be ON as the drive's power is turned ON.

📖 Setting 1: 1 minute after AC motor drive stops, fan will be OFF

📖 Setting 2: AC motor drive runs and fan will be ON. AC motor drive stops and fan will be OFF.

📖 Setting 3: Fan run according to IGBT and capacitance temperature. Fan will be ON when IGBT temperature is higher than 60oC. Fan will be OFF, when capacitance temperature is lower than 40oC.

📖 Setting 4: Fan is always OFF

↗ **07-20** Emergency Stop (EF) & Force Stop

Factory Setting: 0

Settings 0: Coast to stop

1: Stop by 1st deceleration time

- 2: Stop by 2nd deceleration time
- 3: Stop by 3rd deceleration time
- 4: Stop by 4th deceleration time
- 5: System Deceleration (According to original deceleration time)
- 6: Automatic Deceleration (Pr01-46)

When the multi-function input terminal is set to 10(EF) or 18(Emergency stop) and is activated, the drive will stop according to the setting in Pr.07-20.

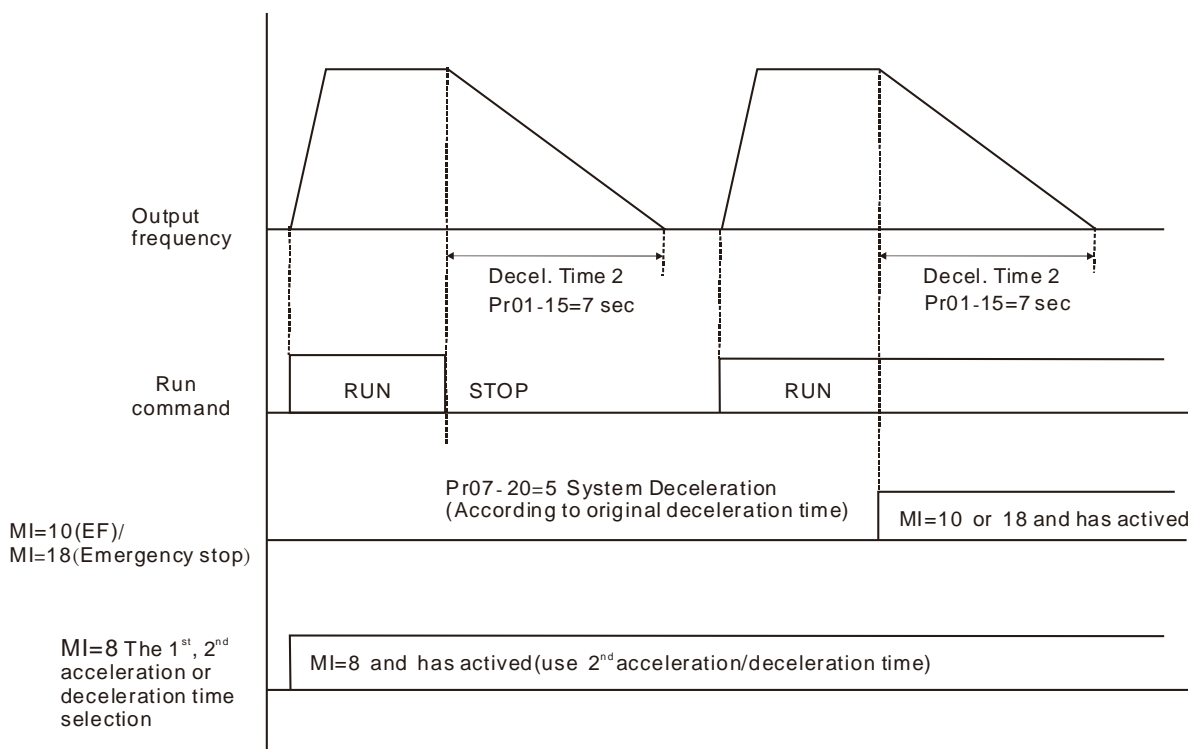
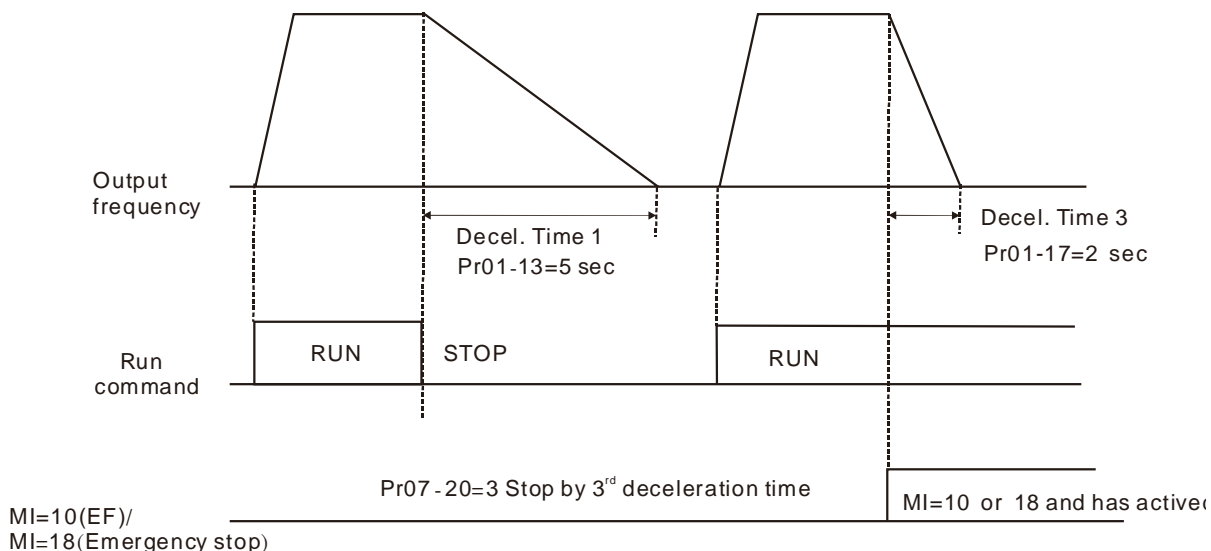

07-21 Auto Energy-saving Operation

Factory Setting: 0

- Settings 0: Disable
1: Enable

When Pr.07-21 is set to 1, the acceleration and deceleration will operate with full voltage. During

constant speed operation, it will auto calculate the best voltage value by the load power for the load. This function is not suitable for the ever-changing load or near full-load during operation.

- 📖 When the output frequency is constant, i.e. constant operation, the output voltage will auto decrease by the load reduction. Therefore, the drive will operate with min. power, multiplication of voltage and current.

↗ **07-22** Energy-saving Gain

Factory Setting: 100

Settings 10~1000%

- 📖 When Pr. 07-21 is set to 1, this parameter can be used to adjust the gain of energy-saving. The factory setting is 100%. If the result is not good, it can adjust by decreasing the setting. If the motor oscillates, it should increase the setting value.

↗ **07-23** Auto Voltage Regulation(AVR) Function

Factory Setting: 0

Settings 0: Enable AVR
 1: Disable AVR
 2: Disable AVR during deceleration

- 📖 Setting 0: when AVR function is enabled, the drive will calculate the output voltage by actual DC-bus voltage. The output voltage won't be changed by DC bus voltage.
- 📖 Setting 1: when AVR function is disabled, the drive will calculate the output voltage by DC-bus voltage. The output voltage will be changed by DC bus voltage. It may cause insufficient/over current.
- 📖 Setting 2: the drive will disable the AVR during deceleration, such as operated from high speed to low speed.
- 📖 When the motor ramps to stop, the deceleration time is longer. When setting this parameter to 2 with auto acceleration/deceleration, the deceleration will be quicker.

↗ **07-24** Filter Time of Torque Command (V/F and SVC control mode)

Factory Setting: 0.500

Settings 0.001~10.000 sec

- 📖 When the setting is too long, the control will be stable but the control response will be delay. When the setting is too short, the response will be quickly but the control may be unstable. User can adjust the setting by the control and response situation.

↗ **07-25** Filter Time of Slip Compensation (V/F and SVC control mode)

Factory Setting: 0.100



Settings 0.001~10.000 sec

- 📖 It can set Pr.07-24 and 07-25 to change the response time of compensation.
- 📖 If Pr.07-24 and 07-25 are set to 10seconds, the response time of compensation is the slowest. But the system may be unstable when the setting is too short.

07-26 Torque Compensation Gain (V/F and SVC control mode)

Factory Setting: 0

Settings 0~10





-  When the motor load is large, a part of drive output voltage is absorbed by the resistor of stator winding and causes insufficient voltage at motor induction and result in over output current and insufficient output torque. It can auto adjust output voltage by the load and keep the air gap magnetic fields stable to get the optimal operation.
-  In the V/F control, the voltage will be decreased in direct proportion when the frequency is decreased. It'll cause decrease torque at low speed due to small AC resistor and the same DC resistor. Therefore, Auto torque compensation function will increase the output voltage in the low frequency to get higher start torque.
-  When Pr.07-26 is set to large, it may cause motor overflux and result in too large output current, motor overheat or triggers protection function.

07-27 Slip Compensation Gain (V/F and SVC control mode)

Factory Setting: 0.00

(1 in SVC mode)

Settings 0.00~10.00

-  The induction motor needs the constant slip to produce magnetic torque. It can be ignore in the higher motor speed, such as rated speed or 2-3% slip.
-  In the operation with variable frequency, the slip and the synchronous frequency will be in reverse proportion to produce the same magnetic torque. That is the slip will be larger with the reduction of synchronous frequency. The motor may stop when the synchronous frequency is decreased to a specific value. Therefore, the slip serious affects the accuracy of motor speed at low speed.
-  In another situation, when the drive uses with induction motor, the slip will be increased by the increasing load. It also affects the accuracy of motor speed.
-  This parameter can be used to set compensation frequency and reduce the slip to close the synchronous speed when the motor runs in the rated current to raise the drive accuracy. When the drive output current is larger than Pr.05-05 No-load Current of Induction Motor 1 (A), the drive will compensation the frequency by this parameter.
-  When the control method (Pr.00-11) is changed from V/f mode to vector mode, this parameter will auto be set to 1.00. Otherwise, it will be set to 0.00. Please do the compensation of slip after overload and acceleration. The compensation value should be increased from small to large gradually. That is to add the output frequency with motor rated slip X Pr.07-27 Slip Compensation Gain when the motor is rated load. If the actual speed ratio is slow than expectation, please increase the setting. Otherwise, decrease the setting.

07-28 Reserved

↗ **07-29** Slip Deviation Level

Factory Setting: 0

Settings 0~100.0%
0: No detection

↗ **07-30** Detection Time of Slip Deviation

Factory Setting:1.0

Settings 0.0~10.0 sec

↗ **07-31** Over Slip Treatment

Factory Setting:0

Settings 0: Warn and keep operation
1: Warn and ramp to stop
2: Warn and coast to stop
3: No warning

📖 The Pr.07-29 to Pr.07-31 is to set allowable slip level/time and over slip treatment when the drive is running.

↗ **07-32** Motor Hunting Gain

Factory Setting:1000

Settings 0~10000
0: Disable

📖 The motor will have current wave motion in some specific area. It can improve this situation by setting this parameter. (When it is high frequency or run with PG, it can be set to 0. when the current wave motion happens in the low frequency, please increase Pr.07-32.)

↗ **07-33** Auto restart internal of Fault

Factory Setting:60.0

Settings 0.0~6000.0 sec

📖 When a reset/restart after fault occurs, the drive will regards Pr.07-33 as a time boundary and begin counting the numbers of faults occur within this time period. Within the period, if numbers of faults occurred did not exceed the setting in Pr.07-11, the counting will be cleared and starts from 0 when next fault occurs. However, if the numbers of faults occurred within this time period have exceed the setting in Pr.07-11, user will need to press RESET key manually for the drive to operate again.

08 High-function PID Parameters

✎ This parameter can be set during operation.

✎ **08-00** Input Terminal for PID Feedback

Factory Setting:0

Settings 0: No function

1: Negative PID feedback: on analogue input acc. To setting 5 of Pr. 03-00 to Pr.03-02.

2~3: Reserved

4: Positive PID feedback from external terminal AVI (Pr.03-00)

5~8: Reserved

- 📖 Negative feedback means: +target value – feedback. It is used for the detection value will be increased by increasing the output frequency.
- 📖 When Pr.03-00 to Pr.03-02 has the same setting, then the AVI will be the prioritized selection.
- 📖 Positive feedback means: -target value + feedback. It is used for the detection value will be decreased by increasing the output frequency.
- 📖 When Pr.08-00≠7 neither ≠8, input value is disabled. The value of the setting remains the same after the drive is off.

Common applications for PID control

- ☑ Flow control: A flow sensor is used to feedback the flow data and performs accurate flow control.
 - ☑ Pressure control: A pressure sensor is used to feedback the pressure data and performs precise pressure control.
 - ☑ Air volume control: An air volume sensor is used to feedback the air volume data to have excellent air volume regulation.
 - ☑ Temperature control: A thermocouple or thermistor is used to feedback temperature data for comfortable temperature control.
 - ☑ Speed control: A speed sensor or encoder is used to feedback motor shaft speed or input another machines speed as a target value for closed loop speed control of master-slave operation. Pr.10.00 sets the PID set point source (target value).
 - ☑ PID control operates with the feedback signal as set by Pr.10.01 either 0~+10V voltage or 4-20mA current.
- 📖 PID control loop:

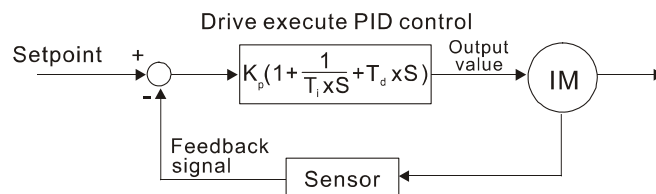

K_p : Proportional gain(P) T_i : Integral time(I) T_d : Derivative control(D) S: Operator

📖 Concept of PID control

1. Proportional gain(P):

the output is proportional to input. With only proportional gain control, there will always be a steady-state error.

2. Integral time(I):

the controller output is proportional to the integral of the controller input. To eliminate the steady-state error, an “integral part” needs to be added to the controller. The integral time decides the relation between integral part and error. The integral part will be increased by time even if the error is small. It gradually increases the controller output to eliminate the error until it is 0. In this way a system can be stable without steady-state error by proportional gain control and integral time control.

3. Differential control(D):

the controller output is proportional to the differential of the controller input. During elimination of the error, oscillation or instability may occur. The differential control can be used to suppress these effects by acting before the error. That is, when the error is near 0, the differential control should be 0. Proportional gain(P) + differential control(D) can be used to improve the system state during PID adjustment.

 When PID control is used in a constant pressure pump feedback application:

Set the application’s constant pressure value (bar) to be the set point of PID control. The pressure sensor will send the actual value as PID feedback value. After comparing the PID set point and PID feedback, there will be an error. Thus, the PID controller needs to calculate the output by using proportional gain(P), integral time(I) and differential time(D) to control the pump. It controls the drive to have different pump speed and achieves constant pressure control by using a 4-20mA signal corresponding to 0-10 bar as feedback to the drive.

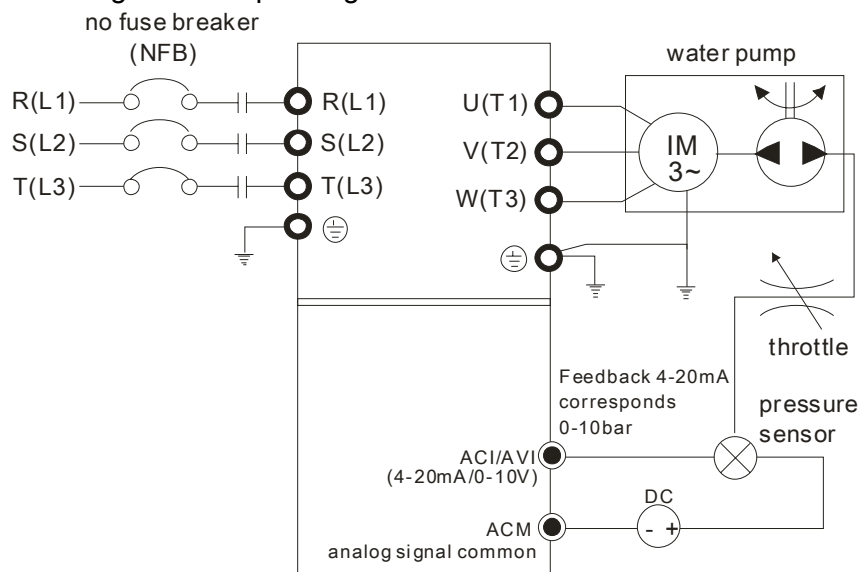



1. Pr.00-04 is set to 10 (Display PID analog feedback signal value (b) (%))
2. Pr.01-12 Acceleration Time will be set as required
3. Pr.01-13 Deceleration Time will be set as required
4. Pr.00-21=0 to operate from the digital keypad
5. Pr.00-20=0, the set point is controlled by the digital keypad
6. Pr.08-00=1 (Negative PID feedback from analog input)
7. ACI analog input Pr. 03-01 set to 5, PID feedback signal.
8. Pr.08-01-08-03 will be set as required
 - 8.1 If there is no vibration in the system, increase Pr.08-01(Proportional Gain (P))
 - 8.2 If there is no vibration in the system, reduce Pr.08-02(Integral Time (I))
 - 8.3 If there is no vibration in the system, increase Pr.08-03(Differential Time(D))

 Refer to Pr.08-00 to 08-21 for PID parameters settings.

08-01 Proportional Gain (P)

Factory Setting:1.0





Settings 0.0~100.0%

-  When the setting is 1.0, it means Kp gain is 100%; setting is 0.5, Kp gain means 50%.
-  It is used to eliminate the system error. It is usually used to decrease the error and get the faster response speed. But if the value is set too high, it may cause the system oscillation and instability.
-  If the other two gains (I and D) are set to zero, proportional control is the only one effective.

08-02 Integral Time (I)

Factory Setting:1.00



Settings 0.00~100.00 sec
0.00: Disable

-  The integral controller is used to eliminate the error during stable system. The integral control doesn't stop working until error is 0. The integral is acted by the integral time. The smaller integral time is set, the stronger integral action will be. It is helpful to reduce overshoot and oscillation to make a stable system. At this moment, the decreasing error will be slow. The integral control is often used with other two controls to become PI controller or PID controller.
-  This parameter is used to set the integral time of I controller. When the integral time is long, it will have small gain of I controller, the slower response and bad external control. When the integral time is short, it will have large gain of I controller, the faster response and rapid external control.
-  When the integral time is too small, it may cause system oscillation.
-  If the integral time is set as 0.00, Pr.08-02 will be disabled.

08-03 Derivative Control (D)

Factory Setting:0.00



Settings 0.00~1.00 sec

-  The differential controller is used to show the change of system error and it is helpful to preview the change of error. So the differential controller can be used to eliminate the error to improve system state. With the suitable differential time, it can reduce overshoot and shorten adjustment time. However, the differential operation will increase the noise interference. Please note that too large differential will cause big noise interference. Besides, the differential shows the change and the output of the differential will be 0 when there is no change. Therefore, the differential control can't be used independently. It needs to be used with other two controllers to make a PD controller or PID controller.
-  This parameter can be used to set the gain of D controller to decide the response of error change. The suitable differential time can reduce the overshoot of P and I controller to decrease the oscillation and have a stable system. But too long differential time may cause system oscillation.
-  The differential controller acts for the change of error and can't reduce the interference. It is not recommended to use this function in the serious interference.

08-04 Upper limit of Integral Control

Factory Setting:100.0

Settings 0.0~100.0%

-  This parameter defines an upper bound or limit for the integral gain (I) and therefore limits the Master Frequency. The formula is: Integral upper bound = Maximum Output Frequency (Pr.01-00) x (Pr.08-04 %).
-  Too large integral value will make the slow response due to sudden load change. In this way, it may cause motor stall or machine damage.

08-05 PID Output Frequency Limit

Factory Setting: 100.0

Settings 0.0~110.0%

-  This parameter defines the percentage of output frequency limit during the PID control. The formula is Output Frequency Limit = Maximum Output Frequency (Pr.01-00) X Pr.08-05 %.

08-06 PID feedback value by communication protocol

Factory Setting: Read only

Settings -200.00%~200.00%

-  When PID feedback input is set as communication (Pr08-00=7 or 8), PID feedback value can be set by this value.

08-07 PID Delay Time







Factory Setting: 0.0

Settings 0.0~35.0 sec

08-20 PID Mode Selection

Factory Setting: 0

 Settings 0: Serial connection
 1: Parallel connection

-  When setting is 0, it uses conventional PID control structure.
-  When setting is 1, proportional gain, integral gain and derivative gain are independent. The P, I and D can be customized to fit users' demand.
-  Pr.08-07 determines the primary low pass filter time when in PID control. Setting a large time constant may slow down the response rate of drive.
-  Output frequency of PID control will filter by primary low pass function. This function could filter mix frequencies. A long primary low pass time means filter degree is high and vice versa.
-  Inappropriate setting of delay time may cause system error.
-  PI Control: controlled by the P action only, and thus, the deviation cannot be eliminated entirely. To eliminate residual deviations, the P + I control will generally be utilized. And when the PI control is utilized, it could eliminate the deviation incurred by the targeted value changes and the constant external interferences. However, if the I action is excessively powerful, it will delay the responding toward the swift variation. The P action could be used solely on the loading system that possesses the integral components.
-  PD Control: when deviation occurred, the system will immediately generate some operation load that is greater than the load generated single handedly by the D action to restrain the increment of the deviation. If the deviation is small, the effectiveness of the P action will be decreasing as

well. The control objects include occasions with integral component loads, which are controlled by the P action only, and sometimes, if the integral component is functioning, the whole system will be vibrating. On such occasions, in order to make the P action's vibration subsiding and the system stabilizing, the PD control could be utilized. In other words, this control is good for use with loadings of no brake functions over the processes.

 PID Control: Utilize the I action to eliminate the deviation and the D action to restrain the vibration, thereafter, combine with the P action to construct the PID control. Use of the PID method could obtain a control process with no deviations, high accuracies and a stable system.

 Serial connection

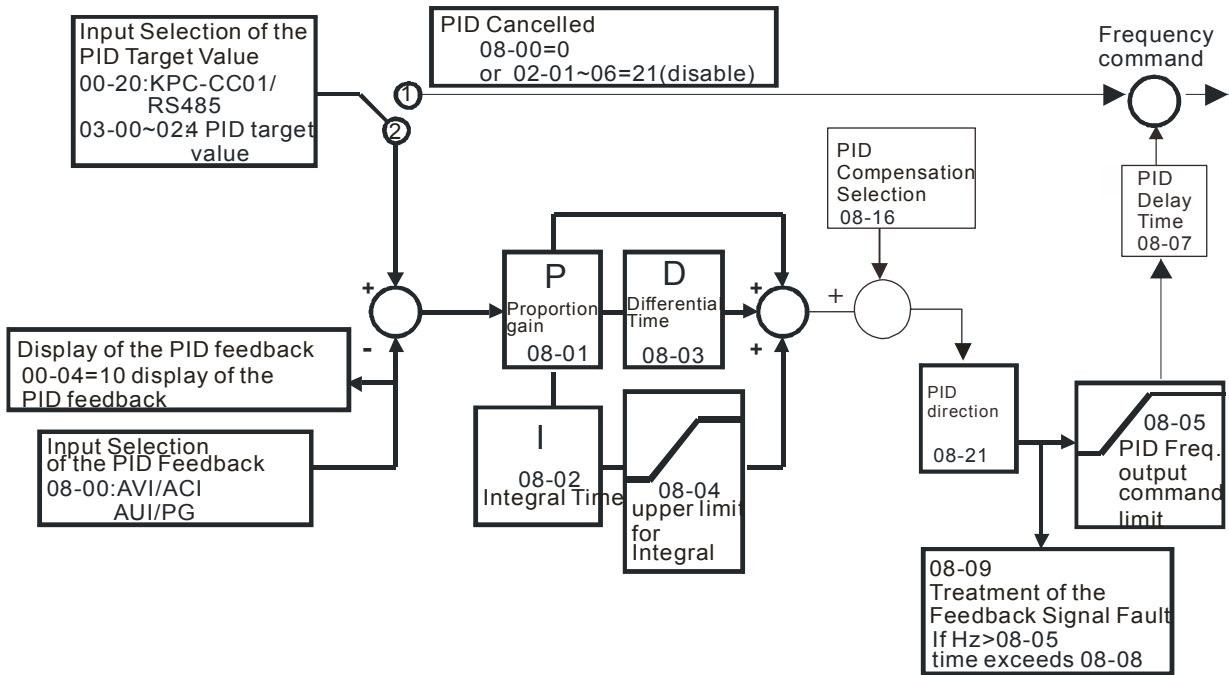

 Parallel connection

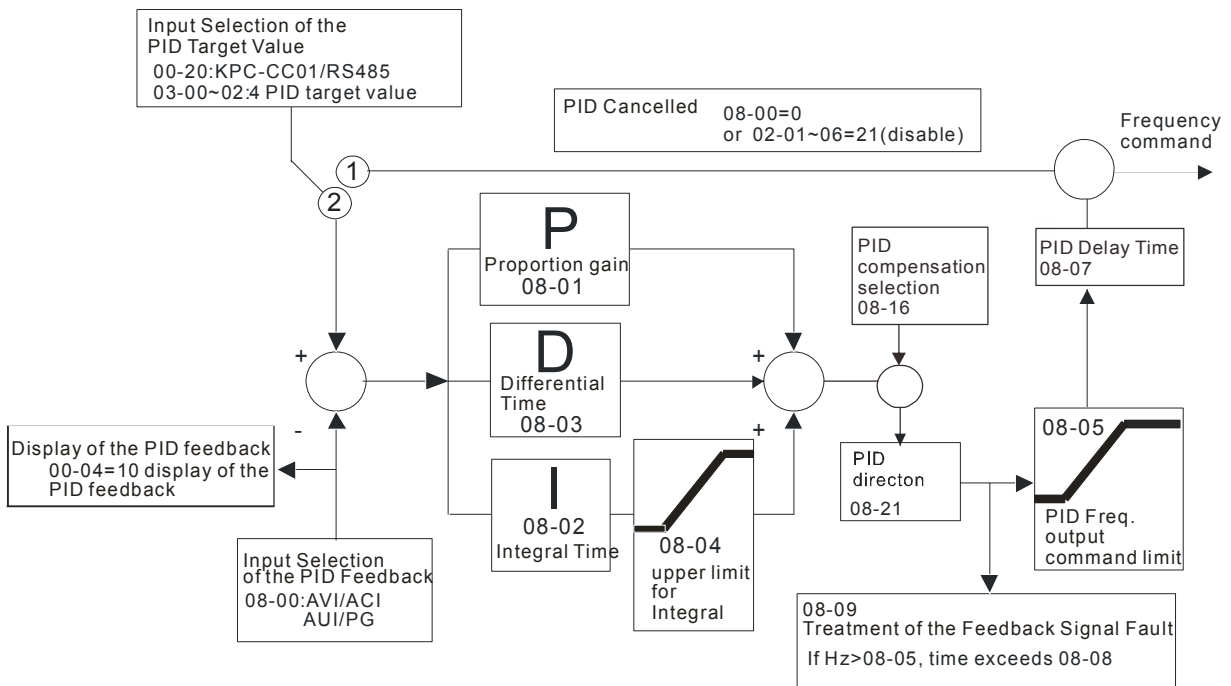

08-08 Feedback Signal Detection Time

Factory Setting: 0.0

Settings 0.0~3600.0 sec

 Pr.08-08 is valid only for ACI 4-20mA.

 This parameter sets the detection time of abnormal PID feedback. If detection time is set to 0.0, detection function is disabled.

08-09 Feedback Signal Fault Treatment

Factory Setting: 0

Settings 0: Warn and keep operation
 1: Warn and ramp to stop
 2: Warn and coast to stop
 3: Warn and operate at last frequency

 This parameter is valid only for ACI 4-20mA.

 AC motor drive acts when the feedback signals analog PID feedback is abnormal.

08-10 Sleep Reference

Factory Setting: 0.00

Settings 0.00~599.00Hz or 0~200.00%

 Setting value of Pr.08-10 determines if sleep reference and wake-up reference is enable or disable. When Pr.08-10 = 0, it means disable. When 08-10 \neq 0, it means enable.

08-11 Wake-up Reference

Factory Setting: 0.00

Settings 0.00~599.00Hz or 0~200.00%

 When Pr.08-18 = 0, the unit of Pr.08-10 and that of Pr.08-11 become frequency. The settings then become 0.00~599.00 Hz.

 When Pr.08-18=1, the unit of Pr.08-10 and that of Pr.08-11 switch to percentage. The settings then switch to 0~200.00%.

 And the percentage is based on the input command not maximum. E.g. If the maximum is 100 Kg, the command now is 30kg, if 08-11=40%, the value is 12kg.It is the same as Pr.08-10.

08-12 Sleep Time

Factory Setting: 0.0









Settings 0.00~6000.0 sec

 When the frequency command is smaller than the sleep frequency and less than the sleep time, the frequency command is equal to the sleep frequency. However the frequency command remains at 0.00Hz until the frequency command becomes equal to or bigger than the wake-up frequency.

08-13 PID Deviation Level

Factory Setting: 10.0

Settings 1.0~50.0%

↗	08-14 PID Deviation Time	Factory Setting: 5.0
	Settings 0.1~300.0 sec	
↗	08-15 Reserved	
↗	08-16 PID Compensation Selection	Factory Setting: 0
	Settings 0: Parameter setting (Pr.08-17) 1: Analog input	
	<p> Pr.08-16=0: PID compensation value is given via Pr08-17 setting.</p> <p> Pr.08-16=1: The PID compensation value is given via analog input(Pr.03-00~03-02=13) and display at Pr.08-17(at this moment, Pr08-17 become read only).</p>	
↗	08-17 PID Compensation	Factory Setting: 0
	Settings -100.0~+100.0%	
	<p> The PID compensation value=Max. PID target value×Pr08-17. For example, the max. output frequency Pr.01-00=60Hz, Pr.08-17=10.0%, PID compensation value will increase output frequency 6.00Hz. $60.00\text{Hz} \times 100.00\% \times 10.0\% = 6.00\text{Hz}$</p>	
	08-18 Setting of Sleep Mode Function	Factory Setting: 0
	Settings 0: Follow PID output command 1: Follow PID feedback signal	
	<p> When Pr.08-18=0, the unit of Pr08-10 and that of Pr.08-11 becomes frequency. The settings then become 0.00~599.00Hz.</p> <p> When Pr.08-18=1, the unit of Pr08-10 and that of Pr.08-11 switches to percentage. The settings then switch to 0~200.00%.</p>	
↗	08-19 Wake-up Integral Limit	Factory Setting: 50.0
	Settings 0.0~200.0%	
	<p> The wake-up integral limit of the VFD is to prevent sudden high speed running when the VFD wakes up.</p> <p> The wake-up integral frequency limit=(01-00×08-19%)</p> <p> The Pr.08-19 is used to reduce the reaction time from sleep to wake-up.</p>	
	08-21 Enable PID to Change the Operation Direction	Factory Setting: 0
	Settings 0: Disable change of direction 1: Enable change of direction	

08-22 Wake-up delay time

Factory Setting: 0.00

Settings 0.00~600.00 sec.

Refer to Pr.08-18 for more information.

08-23 PID Control Bit

Factory Setting: 0

Settings Bit0 =1, PID reverse running must follow the setting of Pr.00-23

Bit0 = 0, PID reverse running follows PID's calculated value

Bit0, when Pr.08-21 = 1, PID reverse running is enable.

Bit0 = 0, if the PID calculated value is positive, it will be forward running. If the PID calculated value is negative, it will be reverse running.

There are three scenarios for sleep and wake-up frequency.

1) Frequency Command (PID is not in use, Pr.08-00. Only works in VF mode)

When the output frequency \leq the sleep frequency and the VFD reach the preset sleep time, then the VFD will be at the sleep mode.

When the frequency command reaches the wake-up frequency, the VFD will start to count the wake-up delay time. Then when the VFD reaches the wake-up delay time, the VFD will begin acceleration time to reach the frequency command.

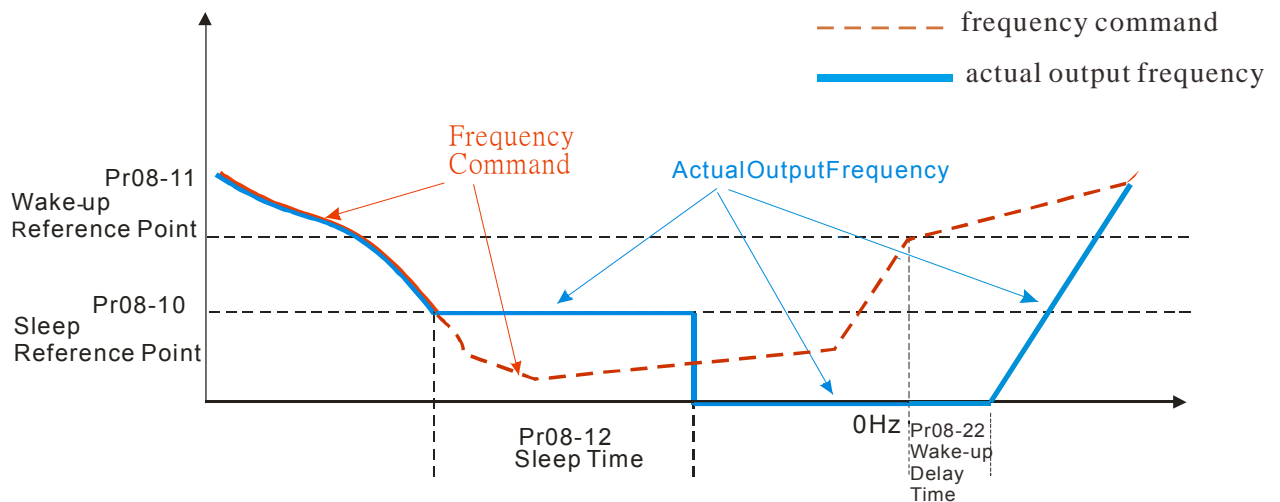

2) Frequency Command Calculation of the Internal PID

When the PID calculation reaches the sleep frequency, the VFD will start to count the sleep time and the output frequency will start to decrease. If the VFD exceeds the preset sleep time, it will directly go to sleep mode which is 0 Hz. But if the VFD doesn't reach the sleep time, it will remain at the lower limit (if there is a preset of lower limit.). Or it will remain at the lowest output frequency set at Pr.01-07 and wait to reach the sleep time then go to sleep mode (0 Hz).

When the calculated frequency command reaches the wake-up frequency, the VFD will start to count the wake-up delay time. Once reaching the wake-up delay time, the VFD will start the acceleration time to reach the PID frequency command.

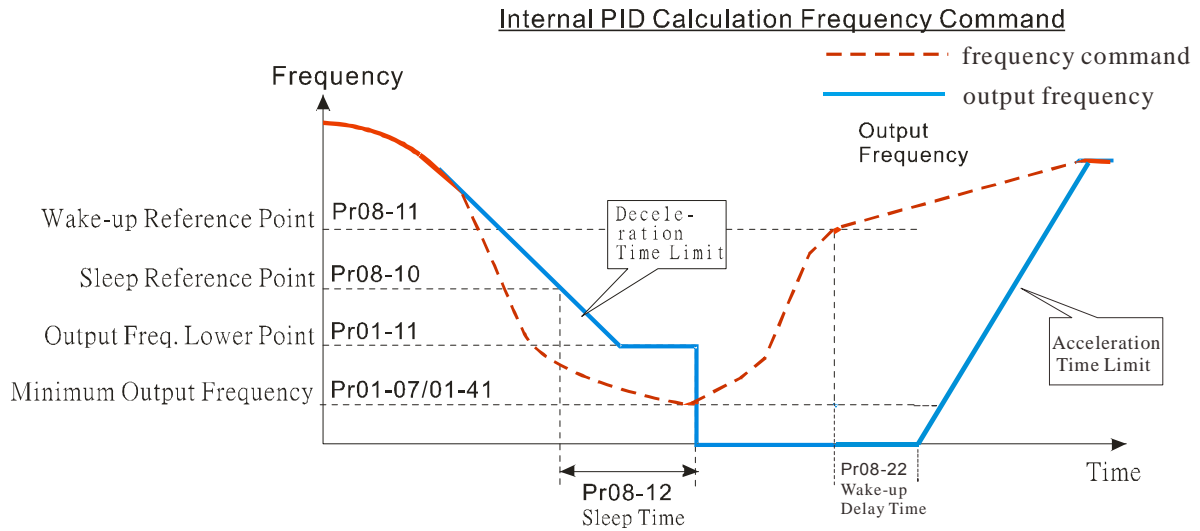

3) PID Feedback Rate Percentage (Use PID, Pr.08-00 ≠ 0 and Pr.08-18=1)

When the PID feedback rate reaches the sleep level percentage, the VFD starts to count the sleep time. The output frequency will also decrease. If the VFD exceeds the preset sleep time, it will go to sleep mode which is 0 Hz. But if the VFD doesn't reach the sleep time, it will remain at the lower limit (if there is a preset of lower limit.). Or it will remain at the lowest output frequency set at Pr.01-07 and wait to reach the sleep time then go to sleep mode (0 Hz).

When PID feedback value reaches the wake up percentage the motor drive will start to count the wake up delay time. Once reaches the wake up delay time, the motor drives starts the accelerating time to reach PID frequency command.

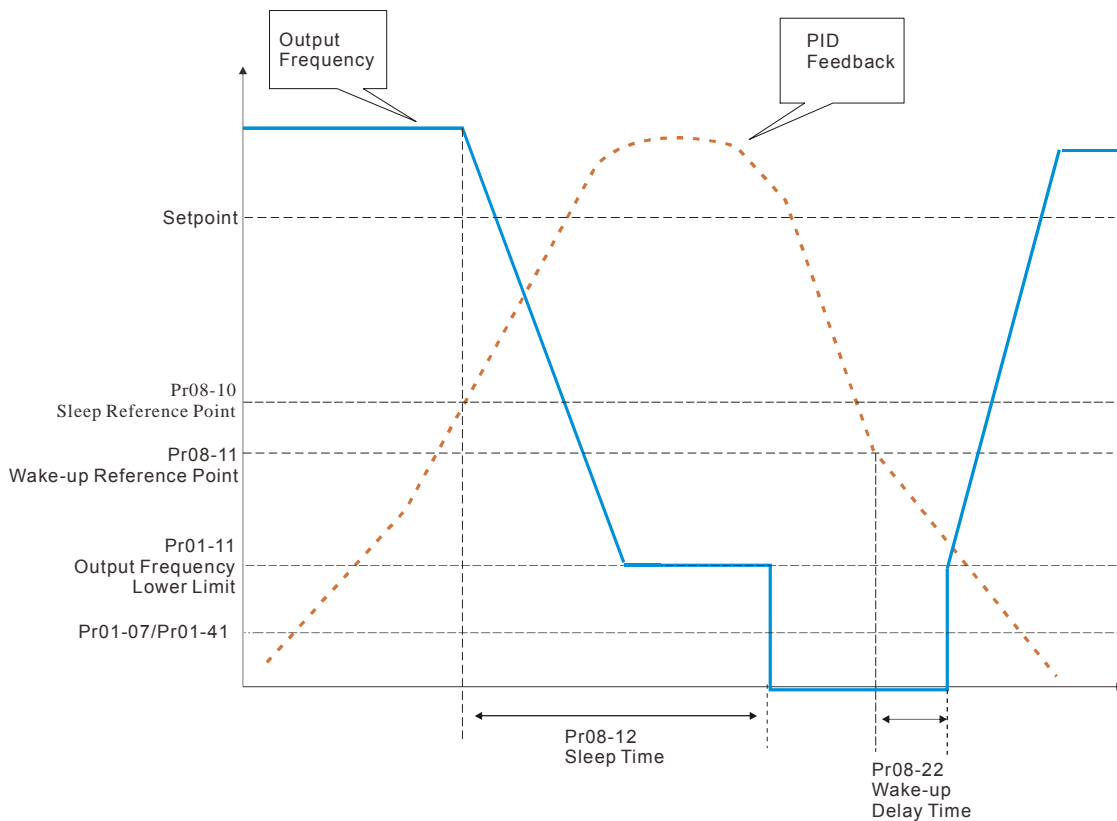

09 Communication Parameters

✎ The parameter can be set during the operation.

When using communication devices, connects AC drive with PC by using Delta IFD6530 or IFD6500.

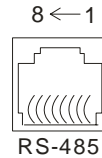

Modbus RS-485
 Pin 1~2,7,8: Reserved
 Pin 3, 6: GND
 Pin 4: SG-
 Pin 5: SG+

✎ 09-00 COM1 Communication Address

Factory Setting: 1

Settings 1~254

📖 If the AC motor drive is controlled by RS-485 serial communication, the communication address for this drive must be set via this parameter and each AC motor drive's communication address must be different.

✎ 09-01 COM1 Transmission Speed

Factory Setting: 9.6

Settings 4.8~115.2Kbits/s

📖 This parameter is for set up the RS485 communication transmission speed.

✎ 09-02 COM1 Transmission Fault Treatment

Factory Setting: 3

Settings 0: Warn and keep operation
 1: Warn and ramp to stop
 2: Warn and coast to stop
 3: No warning and continue operation

📖 This parameter is to set the reaction of MODBUS transmission errors with the host. Detection time can be set in Pr09-03.

✎ 09-03 COM1 Time-out Detection

Factory Setting: 0.0

Settings 0.0~100.0 sec
 0.0: Disable



📖 It is used to set the communication transmission time-out.

✎ 09-04 COM1 Communication Protocol

Factory Setting: 1

Settings 1: 7, N, 2 for ASCII
 2: 7, E, 1 for ASCII
 3: 7, O, 1 for ASCII
 4: 7, E, 2 for ASCII
 5: 7, O, 2 for ASCII
 6: 8, N, 1 for ASCII
 7: 8, N, 2 for ASCII
 8: 8, E, 1 for ASCII

- 9: 8, O, 1 for ASCII
- 10: 8, E, 2 for ASCII
- 11: 8, O, 2 for ASCII
- 12: 8, N, 1 for RTU
- 13: 8, N, 2 for RTU
- 14: 8, E, 1 for RTU
- 15: 8, O, 1 for RTU
- 16: 8, E, 2 for RTU
- 17: 8, O, 2 for RTU

-  Control by PC or PLC (Computer Link)
-  A VFD-CFP2000 can be set up to communicate on Modbus networks using one of the following modes: ASCII (American Standard Code for Information Interchange) or RTU (Remote Terminal Unit). Users can select the desired mode along with the RS-485 serial port communication protocol in Pr.09-00.
-  MODBUS ASCII (American Standard Code for Information Interchange) : Each byte data is the combination of two ASCII characters. For example, a 1-byte data: 64 Hex, shown as '64' in ASCII, consists of '6' (36Hex) and '4' (34Hex).

1. Code Description

Communication protocol is in hexadecimal, ASCII: "0", "9", "A", "F", every 16 hexadecimal represents ASCII code. For example:

Character	'0'	'1'	'2'	'3'	'4'	'5'	'6'	'7'
ASCII code	30H	31H	32H	33H	34H	35H	36H	37H

Character	'8'	'9'	'A'	'B'	'C'	'D'	'E'	'F'
ASCII code	38H	39H	41H	42H	43H	44H	45H	46H

2. Data Format

10-bit character frame (For ASCII):

(7, N, 2)

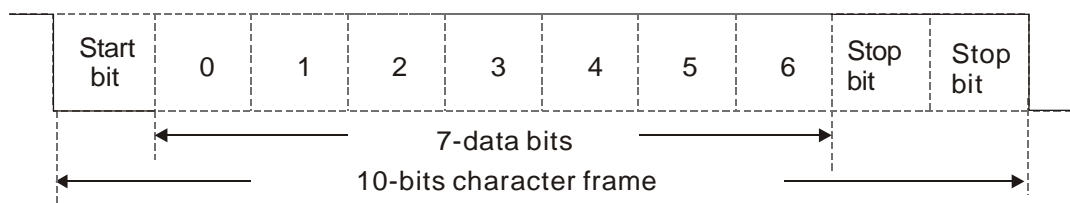

(7, E, 1)

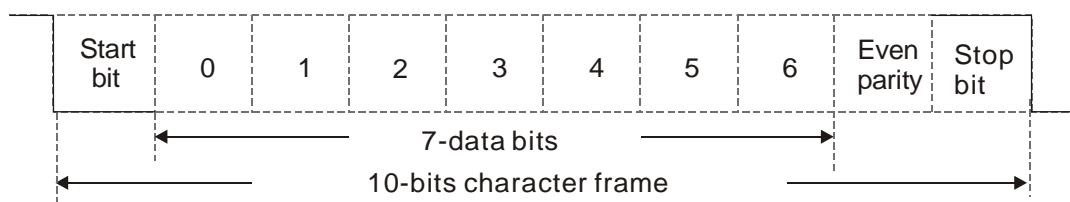

(7, O, 1)

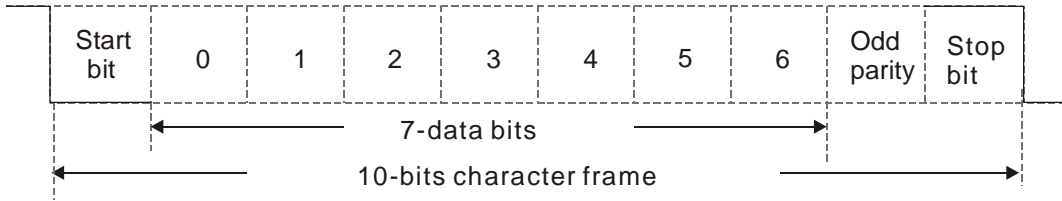

11-bit character frame (For RTU):

(8, N, 2)

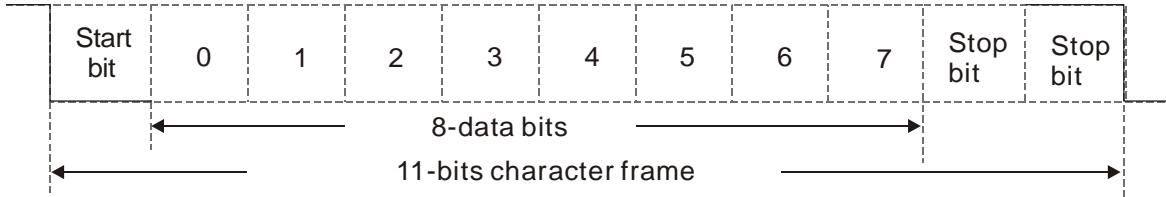

(8, E, 1)

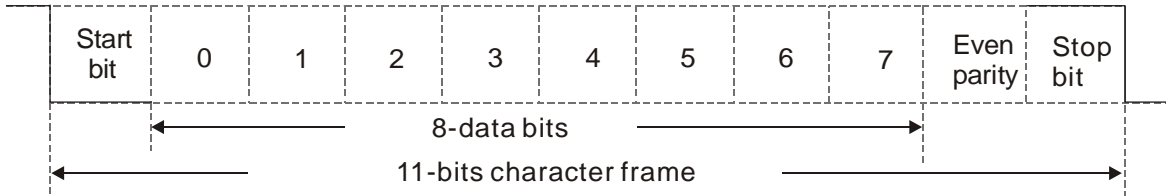

(8, O, 1)

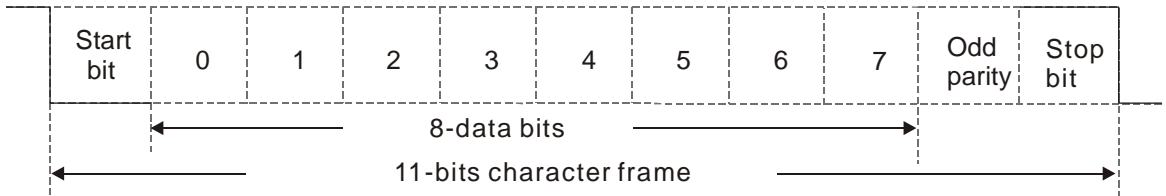

3. Communication Protocol

Communication Data Frame: **ASCII mode**

STX	Start character = ':' (3AH)
Address Hi	Communication address:
Address Lo	8-bit address consists of 2 ASCII codes
Function Hi	Command code:
Function Lo	8-bit command consists of 2 ASCII codes
DATA (n-1)	Contents of data:
.....	Nx8-bit data consist of 2n ASCII codes
DATA 0	n<=16, maximum of 32 ASCII codes
LRC CHK Hi	LRC check sum:
LRC CHK Lo	8-bit check sum consists of 2 ASCII codes
END Hi	End characters:
END Lo	END1= CR (0DH), END0= LF(0AH)

Communication Data Frame: **RTU** mode

START	A silent interval of more than 10 ms
Address	Communication address: 8-bit address
Function	Command code: 8-bit command
DATA (n-1)	Contents of data: n×8-bit data, n≤16
.....	
DATA 0	
CRC CHK Low	CRC check sum: 16-bit check sum consists of 2 8-bit characters
CRC CHK High	
END	A silent interval of more than 10 ms

Address (Communication Address)

Valid communication addresses are in the range of 0 to 254. A communication address equal to 0, means broadcast to all AC drives (AMD). In this case, the AMD will not reply any message to the master device.

00H: broadcast to all AC drives
 01H: AC drive of address 01
 0FH: AC drive of address 15
 10H: AC drive of address 16
 :
 FEH: AC drive of address 254

Function (Function code) and DATA (data characters)

The format of data characters depends on the function code.

03H: read data from register
 06H: write single register

Example: reading continuous 2 data from register address 2102H, AMD address is 01H.

ASCII mode:

Command Message:		Response Message	
STX	‘.’	STX	‘.’
Address	‘0’	Address	‘0’
	‘1’		‘1’
Function	‘0’	Function	‘0’
	‘3’		‘3’
Starting register	‘2’	Number of register (count by byte)	‘0’
	‘1’		‘4’
	‘0’	Content of starting register 2102H	‘1’
	‘2’		‘7’
Number of register (count by word)	‘0’	Content of register 2103H	‘7’
	‘0’		‘0’
	‘0’		‘0’
	‘2’		‘0’
LRC Check	‘D’	LRC Check	‘0’
	‘7’		‘0’
END	CR	END	‘7’
	LF		‘1’
			CR
			LF

RTU mode:

Command Message:		Response Message	
Address	01H	Address	01H
Function	03H	Function	03H
Starting data register	21H	Number of register (count by byte)	04H
	02H		
Number of register (count by word)	00H	Content of register address 2102H	17H
	02H		70H
CRC CHK Low	6FH	Content of register address 2103H	00H
CRC CHK High	F7H		00H
		CRC CHK Low	FEH
		CRC CHK High	5CH

06H: single write, write single data to register.

Example: writing data 6000(1770H) to register 0100H. AMD address is 01H.

ASCII mode:

Command Message:		Response Message	
STX	‘.’	STX	‘.’
Address	‘0’	Address	‘0’
	‘1’		‘1’
Function	‘0’	Function	‘0’
	‘6’		‘6’
Target register	‘0’	Target register	‘0’
	‘1’		‘1’
	‘0’		‘0’
	‘0’		‘0’
Register content	‘1’	Register content	‘1’
	‘7’		‘7’
	‘7’		‘7’
	‘0’		‘0’
LRC Check	‘7’	LRC Check	‘7’
	‘1’		‘1’
END	CR	END	CR
	LF		LF

RTU mode:

Command Message:		Response Message	
Address	01H	Address	01H
Function	06H	Function	06H
Target register	01H	Target register	01H
	00H		00H
Register content	17H	Register content	17H
	70H		70H
CRC CHK Low	86H	CRC CHK Low	86H
CRC CHK High	22H	CRC CHK High	22H

10H: write multiple registers (write multiple data to registers) (at most 20 sets of data can be written simultaneously)

Example: Set the multi-step speed,

Pr.04-00=50.00 (1388H), Pr.04-01=40.00 (0FA0H). AC drive address is 01H.

ASCII Mode

Command Message:		Response Message	
STX	‘.’	STX	‘.’
ADR 1	‘0’	ADR 1	‘0’
ADR 0	‘1’	ADR 0	‘1’
CMD 1	‘1’	CMD 1	‘1’
CMD 0	‘0’	CMD 0	‘0’
Target register	‘0’	Target register	‘0’
	‘5’		‘5’
	‘0’		‘0’
	‘0’		‘0’
Number of register (count by word)	‘0’	Number of register (count by word)	‘0’
	‘0’		‘0’
	‘0’		‘0’
	‘2’		‘2’
Number of register (count by Byte)	‘0’	LRC Check	‘E’
	‘4’		‘8’
The first data content	‘1’	END	CR
	‘3’		LF
	‘8’		
	‘8’		
The second data content	‘0’		
	‘F’		
	‘A’		
	‘0’		
LRC Check	‘9’		
	‘A’		
END	CR		
	LF		

RTU mode:

Command Message:		Response Message:	
ADR	01H	ADR	01H
CMD	10H	CMD 1	10H
Target register	05H	Target register	05H
	00H		00H
Number of register (Count by word)	00H	Number of register (Count by word)	00H
	02H		02H
Quantity of data (Byte)	04	CRC Check Low	41H
The first data content	13H	CRC Check High	04H
	88H		
The second data content	0FH		
	A0H		
CRC Check Low	‘9’		
CRC Check High	‘A’		

Check sum

ASCII mode:

LRC (Longitudinal Redundancy Check) is calculated by summing up, module 256, and the values of the bytes from ADR1 to last data character then calculating the hexadecimal representation of the 2's-complement negation of the sum.

For example,

$01H+03H+21H+02H+00H+02H=29H$, the 2's-complement negation of 29H is **D7H**.

RTU mode:

CRC (Cyclical Redundancy Check) is calculated by the following steps:

Step 1:

Load a 16-bit register (called CRC register) with FFFFH.

Step 2:

Exclusive OR the first 8-bit byte of the command message with the low order byte of the 16-bit CRC register, putting the result in the CRC register.

Step 3:

Examine the LSB of CRC register.

Step 4:

If the LSB of CRC register is 0, shift the CRC register one bit to the right with MSB zero filling, then repeat step 3. If the LSB of CRC register is 1, shift the CRC register one bit to the right with MSB zero filling, Exclusive OR the CRC register with the polynomial value A001H, then repeat step 3.

Step 5:

Repeat step 3 and 4 until eight shifts have been performed. When this is done, a complete 8-bit byte will have been processed.

Step 6:

Repeat step 2 to 5 for the next 8-bit byte of the command message. Continue doing this until all bytes have been processed. The final contents of the CRC register are the CRC value. When transmitting the CRC value in the message, the upper and lower bytes of the CRC value must be swapped, i.e. the lower order byte will be transmitted first.

The following is an example of CRC generation using C language. The function takes two arguments:

Unsigned char* data ← a pointer to the message buffer

Unsigned char length ← the quantity of bytes in the message buffer

The function returns the CRC value as a type of unsigned integer.

Unsigned int crc_chk(unsigned char* data, unsigned char length)

```
{
    int j;
    unsigned int reg_crc=0xffff;
    while(length--){
        reg_crc ^= *data++;
        for(j=0;j<8;j++){
            if(reg_crc & 0x01){ /* LSB(b0)=1 */
                reg_crc=(reg_crc>>1) ^ 0Xa001;
            }else{
                reg_crc=reg_crc >>1;
            }
        }
    }
}
```

```

}
return reg_crc;           // return register CRC
}

```

4. Address list

Content	Register	Function	
AC drive parameters	GGnnH	GG means parameter group, nn means parameter number, for example, the address of Pr 4-01 is 0401H.	
Command write only	2000H	Bit1~0	00B : No function
			01B : Stop
			10B : Run
			11B : JOG
		Bit3~2	Reserved
		Bit5~4	00B : No function
			01B : FWD
			10B : REV
			11B : Change direction
		Bit7~6	00B : 1st accel/decel.
			01B : 2nd accel/decel
			10B : 3rd accel/decel
			11B : 4th accel/decel
		Bit11~8	000B: master speed
			0001B: 1st Step Speed Frequency
			0010B: 2nd Step Speed Frequency
			0011B: 3rd Step Speed Frequency
			0100B: 4th Step Speed Frequency
			0101B: 5th Step Speed Frequency
			0110B: 6th Step Speed Frequency
			0111B: 7th Step Speed Frequency
			1000B: 8th Step Speed Frequency
			1001B: 9th Step Speed Frequency
			1010B: 10th Step Speed Frequency
			1011B: 11th Step Speed Frequency
			1100B: 12th Step Speed Frequency
			1101B: 13th Step Speed Frequency
1110B: 14th Step Speed Frequency			
1111B: 15th Step Speed Frequency			
Bit12	1: Enable bit06-11 function		
Bit14~13	00B : No function		
	01B : Operated by digital keypad		
	10B : Operated by Pr.00-21 setting		
	11B : Change operation source		
Bit15	Reserved		
2001H	Frequency command(XXX.XXHz)		
2002H	Bit0	1 : EF (external fault) on	
	Bit1	1 : Reset	
	Bit2	1 : B.B ON	
	Bit15~3	Reserved	

Content	Register	Function	
Status monitor read only	2100H	High byte: Warn Code Low Byte: Error Code	
	2101H	Bit1~0	AC Drive Operation Status 00B: Drive stops 01B: Drive decelerating 10B: Drive standby 11B: Drive operating
		Bit2	1 : JOG Command
		Bit4~3	Operation Direction 00B: FWD run 01B: From REV run to FWD run 10B: REV run 11B: From FWD run to REV run
		Bit8	1 : Master frequency controlled by communication interface
		Bit9	1 : Master frequency controlled by analog signal
		Bit10	1 : Operation command controlled by communication interface
		Bit11	1 : Parameter locked
		Bit12	1 : Enable to copy parameters from keypad
		Bit15~13	Reserved
	2102H	Frequency command (XXX.XX Hz)	
	2103H	Output frequency (XXX.XX Hz)	
	2104H	Output current (XX.XXA) . When current is higher than 655.35,it will shift decimal as (XXX.XA) . The decimal can refer to High byte of 211F.	
	2105H	DC-BUS Voltage (XXX.XV)	
	2106H	Output voltage (XXX.XV)	
	2107H	Current step number of Multi-Step Speed Operation	
	2108H	Reserved	
	2109H	Counter value	
	210AH	Power Factor Angle (XXX.X)	
	210BH	Output Torque (XXX.X%)	
210CH	Actual motor speed (XXXXXrpm)		
210DH	Reserved		
210EH	Reserved		
210FH	Power output (X.XXX KWH)		
2116H	Multi-function display (Pr.00-04)		
211BH	Max. operation frequency (Pr.01-00) or Max. user defined value (Pr.00-26) When Pr00-26 is 0, this value is equal to Pr01-00 setting When Pr00-26 is not 0, and the command source is Keypad, this value = Pr00-24 * Pr00-26 / Pr01-00 When Pr00-26 is not 0, and the command source is 485, this value = Pr09-10 * Pr00-26 / Pr01-00		
211FH	High byte: decimal of current value (display)		
2200H	Display output current (A). When current is higher than 655.35,it will shift decimal as (XXX.XA) . The decimal can refer to High byte of 211F.		
2201H	Display counter value (c)		
2202H	Actual output frequency (XXXXXHz)		
2203H	DC-BUS voltage (XXX.XV)		
2204H	Output voltage (XXX.XV)		
2205H	Power angle (XXX.X)		

Content	Register	Function
	2206H	Display actual motor speed kW of U, V, W (XXXXXkW)
	2207H	Display motor speed in rpm estimated by the drive or encoder feedback (XXXXXrpm)
	2208H	Display positive/negative output torque in %, estimated by the drive (t0.0: positive torque, -0.0: negative torque) (XXX.X%)
	2209H	Reserved
	220AH	PID feedback value after enabling PID function (XXX.XX%)
	220BH	Display signal of AVI analog input terminal, 0-10V corresponds to 0.00~100.00% (1.) (as Pr. 00-04 NOTE 2)
	220CH	Display signal of ACI analog input terminal, 4-20mA/0-10V corresponds to 0.00~100.00% (2.) (as Pr. 00-04 NOTE 2)
	220DH	Display signal of AUI analog input terminal, -10V~10V corresponds to -100.00~100% (3.) (as Pr. 00-04 NOTE 2)
	220EH	IGBT temperature of drive power module (XXX.X°C)
	220FH	The temperature of capacitance (XXX.X°C)
	2210H	The status of digital input (ON/OFF), refer to Pr.02-12 (as Pr. 00-04 NOTE 3)
	2211H	The status of digital output (ON/OFF), refer to Pr.02-18 (as Pr. 00-04 NOTE 4)
	2212H	The multi-step speed that is executing (S)
	2213H	The corresponding CPU pin status of digital input (d.) (as Pr. 00-04 NOTE 3)
	2214H	The corresponding CPU pin status of digital output (O.) (as Pr. 00-04 NOTE 4)
	2215H ~ 2218H	Reserved
	2219H	Display times of counter overload (XXX.XX%)
	221AH	GFF (XXX.XX%)
	221BH	DCbus voltage ripples (XXX.XV)
	221CH	PLC register D1043 data (C)
	221DH	Reserved
	221EH	User page displays the value in physical measure
	221FH	Output Value of Pr.00-05 (XXX.XXHz)
	2220H	Reserved
	2221H	Reserved
	2222H	Fan speed of the drive (XXX%)
	2223H	Control mode of the drive 0: speed mode 1: torque mode
	2224H	Carrier frequency of the drive (XXKHZ)
	2225H	Reserved
	2226H	Drive status bit 1~0 00b: No direction 01b: Forward 10b: Reverse bit 3~2 01b: Driver ready 10b: Error bit 4 0b: Motor drive did not output 1b: Motor drive did output bit 5 0b: No alarm 1b: Have Alarm
	2227H	Drive's estimated output torque(positive or negative direction) (XXXX Nt-m)
	2228H	Reserved
	2229H	KWH display (XXXX.X)

Content	Register	Function
	222AH ~ 222DH	Reserved
	222EH	PID reference (XXX.XX%)
	222FH	PID offset (XXX.XX%)
	2230H	PID output frequency (XXX.XXHz)
	2231H	Hardware ID

5. Exception response:

The AC motor drive is expected to return a normal response after receiving command messages from the master device. The following depicts the conditions when no normal response is replied to the master device.

The AC motor drive does not receive the messages due to a communication error; thus, the AC motor drive has no response. The master device will eventually process a timeout condition.

The AC motor drive receives the messages without a communication error, but cannot handle them. An exception response will be returned to the master device and an error message “CExx” will be displayed on the keypad of AC motor drive. The xx of “CExx” is a decimal code equal to the exception code that is described below.

In the exception response, the most significant bit of the original command code is set to 1, and an exception code which explains the condition that caused the exception is returned.

Example:

ASCII mode:		RTU mode:	
STX	‘.’	Address	01H
Address	‘0’	Function	86H
	‘1’	Exception code	02H
Function	‘8’	CRC CHK Low	C3H
	‘6’	CRC CHK High	A1H
Exception code	‘0’		
	‘2’		
LRC CHK	‘7’		
	‘7’		
END	CR		
	LF		

The explanation of exception codes:

Exception code	Explanation
1	Function code is not supported or unrecognized.
2	Address is not supported or unrecognized.
3	Data is not correct or unrecognized.
4	Fail to execute this function code

09-05	Reserved
~	
09-08	

09-09	Response Delay Time
--------------	---------------------

Factory Setting: 2.0

Settings 0.0~200.0ms

 This parameter is the response delay time after AC drive receives communication command as shown in the following.

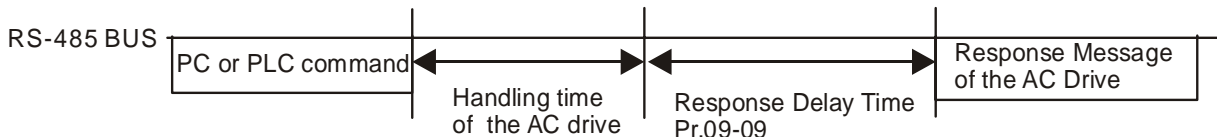

09-10 Main Frequency of the Communication

Factory Setting: 60.00

Settings 0.00~599.00Hz

When Pr.00-20 is set to 1 (RS485 communication). The AC motor drive will save the last frequency command into Pr.09-10 when abnormal turn-off or momentary power loss. After reboots the power, it will regard the frequency set in Pr.09-10 if no new frequency command is inputted. When frequency command of 485 is changed (the source of frequency command needs to be set as MODBUS), this parameter is also be changed.

✓	09-11	Block Transfer 1
✓	09-12	Block Transfer 2
✓	09-13	Block Transfer 3
✓	09-14	Block Transfer 4
✓	09-15	Block Transfer 5
✓	09-16	Block Transfer 6
✓	09-17	Block Transfer 7
✓	09-18	Block Transfer 8
✓	09-19	Block Transfer 9
✓	09-20	Block Transfer 10
✓	09-21	Block Transfer 11
✓	09-22	Block Transfer 12
✓	09-23	Block Transfer 13
✓	09-24	Block Transfer 14
✓	09-25	Block Transfer 15
✓	09-26	Block Transfer 16

Factory Setting: 0000h

Settings 0~FFFF

There is a group of block transfer parameter available in the AC motor drive (Pr.09-11 to Pr.09-26). Through communication code 03H, user can use them (Pr.09-11 to Pr.09-26) to save those parameters that you want to read.

09-27	Reserved
~	
09-29	

09-30 Communication Decoding Method

Factory Setting: 1

Settings 0: Decoding Method 1 (20xx)

1: Decoding Method 2 (60xx)

		Decoding Method 1	Decoding Method 2
Source of Operation Control	Digital Keypad	Digital keypad controls the drive action regardless decoding method 1 or 2.	
	External Terminal	External terminal controls the drive action regardless decoding method 1 or 2.	
	RS-485	Refer to address: 2000h~20FFh	Refer to address: 6000h ~ 60FFh
	CANopen	Refer to index: 2020-01h~2020-FFh	Refer to index:2060-01h ~ 2060-FFh
	Communication Card	Refer to address: 2000h ~ 20FFh	Refer to address: 6000h ~ 60FFh
	PLC	PLC commands the drive action regardless decoding method 1 or 2.	

09-31 Internal Communication Protocol

Factory Setting: 0

- Settings
- 0: Modbus 485
 - 1: Internal Communication Slave 1
 - 2: Internal Communication Slave 2
 - 3: Internal Communication Slave 3
 - 4: Internal Communication Slave 4
 - 5: Internal Communication Slave 5
 - 6: Internal Communication Slave 6
 - 7: Internal Communication Slave 7
 - 8: Internal Communication Slave 8
 - 9: Reserved
 - 10: Internal Communication Master
 - 11: Reserved
 - 12: Internal PLC Control

 When it is defined as internal communication, see CH16-10 for information on Main Control Terminal of Internal Communication.

 When it is defined as internal PLC control, see CH16-12 for Remote IO control application (by using MODRW).

09-32 Reserved
09-34

 **09-33** PLC command force to 0

Factory Setting : 0000h

Setting 0000~FFFF

 It defines the action that before PLC scans time sequence, the frequency command or speed command needs to be cleared as 0 or not.

Bit	Explanation
Bit0	Before PLC scan, set up PLC target frequency=0
Bit1	Before PLC scan, set up the PLC target torque=0
Bit2	Before PLC scan, set up the speed limit of torque control mode=0

09-35 PLC Address

Factory Setting: 2

Settings 1~254

09-36 CANopen Slave Address

Factory Setting: 0

Settings 0: Disable

1~127

09-37 CANopen Speed

Factory Setting: 0

Settings 0: 1M bps

1: 500K bps

2: 250K bps

3: 125K bps

4: 100K bps (Delta only)

5: 50K bps

09-38 Reserved**09-39** CANopen Warning Record

Factory Setting: 0

Settings bit 0: CANopen Guarding Time out

bit 1: CANopen Heartbeat Time out

bit 2: CANopen SYNC Time out

bit 3: CANopen SDO Time out

bit 4: CANopen SDO buffer overflow

bit 5: Can Bus Off

bit 6: Error protocol of CANOPEN

bit 7: Reserved

bit 8: The setting values of CANopen indexes are fail

bit 9: The setting value of CANopen address is fail

bit10: The checksum value of CANopen indexes is fail

09-40 CANopen Decoding Method

Factory Setting: 1

Settings 0: Delta defined decoding method

1: CANopen Standard DS402 protocol

09-41 CANopen Status

Factory Setting: Read Only

Settings 0: Node Reset State

1: Com Reset State

2: Boot up State

3: Pre Operation State

4: Operation State

5: Stop State

09-42 CANopen Control Status

Factory Setting: Read Only

- Settings
- 0: Not ready for use state
 - 1: Inhibit start state
 - 2: Ready to switch on state
 - 3: Switched on state
 - 4: Enable operation state
 - 7: Quick stop active state
 - 13: Err reaction activation state
 - 14: Error state

09-43 Reserved

09-44 Reserved

09-45 CANopen Master Function

Factory Setting: 0

- Settings
- 0: Disable
 - 1: Enable

09-46 CANopen Master Address

Factory Setting: 100

- Settings 0~127

09-47
~ Reserved

09-49

09-50 BACnet Dnet

Factory Setting: 10

- Settings 0~127

09-51 BACnet Baud Rate

Factory Setting: 38.4

- Settings 9.66~76.8 kbps

09-52 BACnet Device ID L

Factory Setting: 10

- Settings 0~65535

09-53 BACnet Device ID H

Factory Setting: 0

- Settings 0~63

09-54 Reserved

09-55 BACnet Max Address

Factory Setting: 127

Settings 0~127

09-56 BACnet Password

Factory Setting: 0

Settings 0~65535

09-57

~ Reserved

09-59

09-60 Identifications for Communication Card

Factory Setting: 0

- Settings 0: No communication card
- 1: DeviceNet Slave
- 2: Profibus-DP Slave
- 3: CANopen Slave/Master
- 4: Modbus-TCP Slave
- 5: EtherNet/IP Slave
- 6~8: Reserved

09-61 Firmware Version of Communication Card

Factory Setting: ##

Settings Read only

09-62 Product Code

Factory Setting: ##

Settings Read only

 Different communication cards have their own product codes with different value.
 DeviceNet: As it connects to different kind of motor drive, it will have different product code.
 Profibus: ID number of a communication card. Each Profibus selling in the market must apply for an ID number at the Profibus International to be a unique product.

09-63 Fault Code

Factory Setting: ##

Settings Read only

 For more information about Fault codes, refer to Pr. 06-17~06-22 and Chapter 14.

09-64

~ Reserved

09-69

✎ **09-70** Address of Communication Card (for DeviceNet and PROFIBUS)

Factory Setting: 1

Settings DeviceNet: 0-63
Profibus-DP: 1-125

✎ **09-71** Setting of DeviceNet Speed (according to Pr.09-72) (for DeviceNet and PROFIBUS)

Factory Setting: 2

Settings Standard DeviceNet:
0: 125Kbps
1: 250Kbps
2: 500Kbps
Non standard DeviceNet: (Delta only)
0: 10Kbps
1: 20Kbps
2: 50Kbps
3: 100Kbps
4: 125Kbps
5: 250Kbps
6: 500Kbps
7: 800Kbps
8: 1Mbps

✎ **09-72** Other Setting of DeviceNet Speed (for DeviceNet and PROFIBUS)

Factory Setting: 0

Settings 0: Standard DeviceNet
1: Nonstandard DeviceNet

📖 It needs to use with Pr.09-71.

📖 Setting 0: the baud rate can only be set to 0, 1, 2 or 3.

📖 Setting 1: setting of DeviceNet communication rate can be the same as CANopen (setting 0-8).

09-73 Reserved

09-74 Reserved

✎ **09-75** IP Configuration of the Communication Card (for MODBUS TCP)

Factory Setting: 0

Settings 0: Static IP
1: DynamicIP (DHCP)

📖 Setting 0: it needs to set IP address manually.

📖 Setting 1: IP address will be auto set by host controller.

✎ **09-76** IP Address 1 of the Communication Card (for MODBUS TCP)

✎ **09-77** IP Address 2 of the Communication Card (for MODBUS TCP)

✎ **09-78** IP Address 3 of the Communication Card (for MODBUS TCP)

✎ **09-79** IP Address 4 of the Communication Card (for MODBUS TCP)

Factory Setting: 0

Settings 0~65535

📖 Pr.09-76~09-79 needs to use with communication card.

✎ **09-80** Address Mask 1 of the Communication Card (for MODBUS TCP)

↗	09-81	Address Mask 2 of the Communication Card (for MODBUS TCP)
↗	09-82	Address Mask 3 of the Communication Card (for MODBUS TCP)
↗	09-83	Address Mask 4 of the Communication Card (for MODBUS TCP)

Factory Setting: 0

Settings 0~65535

↗	09-84	Getway Address 1 of the Communication Card (for MODBUS TCP)
↗	09-85	Getway Address 2 of the Communication Card (for MODBUS TCP)
↗	09-86	Getway Address 3 of the Communication Card (for MODBUS TCP)
↗	09-87	Getway Address 4 of the Communication Card (for MODBUS TCP)

Factory Setting: 0

Settings 0~65535

↗	09-88	Password for Communication Card (Low word) (for MODBUS TCP)
↗	09-89	Password for Communication Card (High word) (for MODBUS TCP)

Factory Setting: 0

Settings 0~99

↗	09-90	Reset Communication Card (for MODBUS TCP)
---	--------------	---

Factory Setting: 0

Settings 0: Disable

1: Reset, return to factory setting

↗	09-91	Additional Setting for Communication Card (for MODBUS TCP)
---	--------------	--

Factory Setting: 1

Settings Bit 0: Enable IP Filter

Bit 1: Internet parameters enable(1bit)

When IP address is set up, this bit need to be enabled to write down the parameters. This bit will change to disable when it finishes saving the update of internet parameters.

Bit 2: Login password enable(1bit)

When enter login password, this bit will be enabled. After updating the parameters of communication card, this bit will change to disable.

	09-92	Status of Communication Card (for MODBUS TCP)
--	--------------	---

Factory Setting: 0

Settings Bit 0: password enable

When the communication card is set with password, this bit is enabled.

When the password is clear, this bit is disabled.

10 Speed Feedback Control Parameters

✎ This parameter can be set during operation.

In this parameter group, ASR is the abbreviation for Adjust Speed Regulator and PG is the abbreviation for Pulse Generator.

10-00
~ Reserved

10-30

✎ **10-31** I/F Mode, current command

Factory Setting: 40



Settings 0~150% rated current of motor

-  The parameter is the current command of the drive in low-speed area (low-speed area: frequency command < Pr.10-39). When it is stalling on heavy duty start-up or forward / reverse with load, adjust the parameter (increase). If inrush current is too high to cause oc stall, then decrease it.

✎ **10-32** PM Sensorless Observer Bandwidth for High Speed Zone

Factory Setting: 5.00

Settings 0.00~599.00Hz



-  The parameter is speed estimator bandwidth. Adjust the parameter will influence the stability and the accuracy of speed for motor.
-  If there is low frequency vibrates (the waveform is similar to sin wave) during the process, then increase the bandwidth. If there is high frequency vibrates (the waveform vibrates extremely and is like spur), then decrease the bandwidth.

10-33 Reserved

✎ **10-34** PM Sensorless Observer Low-pass Filter Gain

Factory Setting: 1.00

Settings 0.00~655.35

-  Adjust the parameter will influence the response speed of speed estimator.
-  If there is low frequency vibrates (the waveform is similar to sin wave) during the process, then increase the gain. If there is high frequency vibrates (the waveform vibrates extremely and is like spur), then decrease the gain.



10-35
~ Reserved

10-38

✎ **10-39** Frequency Point when switch from I/F mode to PM Sensorless mode

Factory Setting: 20.00

Settings 0.00~599.00Hz



-  The parameter is the switch point which is from low frequency to high frequency.
-  If the switch point is too low, motor will not generate enough back EMF to let the speed estimator measure the right position and speed of rotator, and cause stall and oc when the frequency of switch point is running.

-  If the switch point is too high, the active area of I/F will be too wide, which will generate larger current and cannot save energy. (The reason is that if the current of Pr.10-31 sets too high, and the high switch point will make the drive keeps outputting with the setting value of Pr.10-31).

10-40 Frequency Point when Switch from PM Sensorless Mode to I/F Mode

Factory Setting: 20.00



Settings 0.00~599.00Hz

-  The parameter is the switch point which is from high frequency to low frequency.
-  If the switch point is too low, motor will not generate enough back EMF to let the speed estimator measure the right position and speed of rotor when the frequency of switch point is running.
-  If the switch point is too high, the active area of I/F will be too wide, which will generate larger current and cannot save energy. (The reason is that if the current of Pr.10-31 sets too high, and the high switch point will make the drive keeps outputting with the setting value of Pr.10-31).

10-41 I/F mode, low pass-filter time

Factory Setting: 0.2



Settings 0.0~6.0 sec

-  This parameter is the filter time of Pr.10-31.It can let magnetic field under I/F mode increased smoothly to the current command setting value.
-  If you want to increase the size of Id slowly, you can adjust high to avoid the starting current output Step phenomenon; If you adjust to low (minimum 0), the faster the current rises, there will be a Step phenomenon.

10-42 Initial Angle Detection Pulse Value

Factory Setting: 1.0



Settings 0.0~3.0

-  The angle detection is fixed to 3: Use the pulse injection method to start. The parameter influences the value of pulse during the angle detection. The larger the pulse is, the higher of the accuracy of rotor's position. But larger pulse might cause oc easily.
-  Increase the parameter when the running direction and the command are opposite while start-up. If oc occurs in the start-up moment, then decrease the parameter.
-  Please refer to Chapter 12-2 Adjustment & Application for detailed motor adjustment procedure.

10-49 Zero voltage time while start up

Factory Setting: 00.000

Settings 00.000~60.000 sec

-  When the motor is in static status at the startup, the accuracy to estimate angles will be increased. In order to make the motor in "static status", the drive 3 phase U, V, W output 0V to motor to reach this goal. The Pr.10-49 setting time is the length of time when three-phase output 0V.
-  It is possible that even when this parameter is being applied but the motor at the installation site cannot go in to the "static status" caused by the inertia or by any external force. So, if the motor doesn't go into a completer "static status" in 0.2 sec, increase appropriately this setting value. This parameter is functional only when the setting of Pr.07-12 Speed Search during Startup ≠0.

10-51 Injection Frequency

Factory Setting: 500

Settings 0~1200Hz

-  This parameter is a high frequency injection command in PM SVC control mode, and usually it

doesn't need to be adjusted. But if a motor's rated frequency (i.e. 400 Hz) is too close to the frequency setting of this parameter (i.e. factory setting 500 Hz), the accuracy of angles detected will be affected. Therefore, refer to the setting of Pr.01-01 before adjusting this parameter.

 If the setting value of Pr.00-17 is lower than Pr.10-51*10, then increase the frequency of carrier wave.

 Pr.10-51 is valid only when Pr.10-53 = 2.

10-52 Injection Magnitude

Factory Setting: 15.0/30.0

Settings 0.0~200.0V

 The parameter is magnitude command of high frequency injection signal in PM SVC control mode.

 Increasing the parameter can get more accurate estimated value of angle. But the noise of electromagnetic might be louder if the setting value is too high.

 This parameter will be received when motor's parameter is "Auto". And this parameter will influence the accuracy of angle's estimation.

 When the ratio of salient pole (L_q / L_d) is lower, increase Pr. 10-52 to make angle detection be accurate.

 Pr.10-52 is valid only when Pr. 10-53 = 2.

10-53 PM Motor Rotor Initial Angle Position Detection Method

Factory Setting : 0

Settings 0 : Disabled

1 : Internal 1/4 rated current attracting the rotor to zero degrees

2 : High frequency injection

3 : Pulse injection

4~5 : Reserved

 It is suggested to set as "2" if it is IPM; set as "3" if it is SPM. If there is bad effect when set as "2" or "3", then set as "1".

11 Advanced Parameters

Group 11 Advanced Parameters are reserved.

12 Pump Parameters

✎ This parameter can be set during operation.

12-00
Circulative Control

Factory Setting: 0

- Settings
- 0: No operation
 - 1: Fixed Time Circulation (by time)
 - 2: Fixed Quantity
 - 3: Fixed quantity control
 - 4: Fixed Time Circulation + Fixed Quantity Circulation
 - 5: Fixed Time Circulation + Fixed Quantity Control

📖 In this mode, CFP2000 can control up to 8 motors at a time. The total number of the motors can be determined by Pr.12-01. In accordance with the Fixed Time Circulation of Pr12-02, you can adjust the switching time between Start/Stop of each motor. That means when an operating motor reaches the time setting of Pr12-02, CFP2000 will stop that motor. Then after the delay time setting of Pr12-03, next motor will start operating. See diagram below.

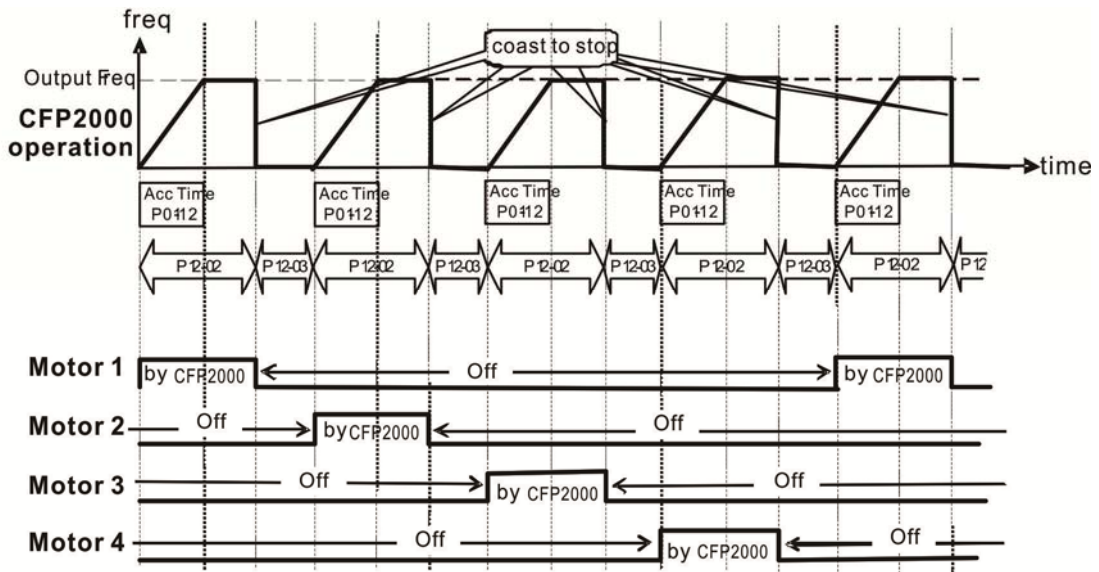

Diagram 12-1: Sequential Diagram of the Fixed Time Circulation (by time)

📖 Disable Motors' Output

Set the Multifunction Input Commands as Disable Motors' Output can stop corresponding motors. The settings are:

P02-01~P02-06=	60	61	62	63	64	65	66	67	68
Disable Motors' Output	ALL	1	2	3	4	5	6	7	8

When a motor's output is disabled, this motor will park freely.

Wiring: Fixed Time Circulation (by time) Control can control up to 8 motors. The diagram 12-2 is an example of controlling 4 motors at the same time.

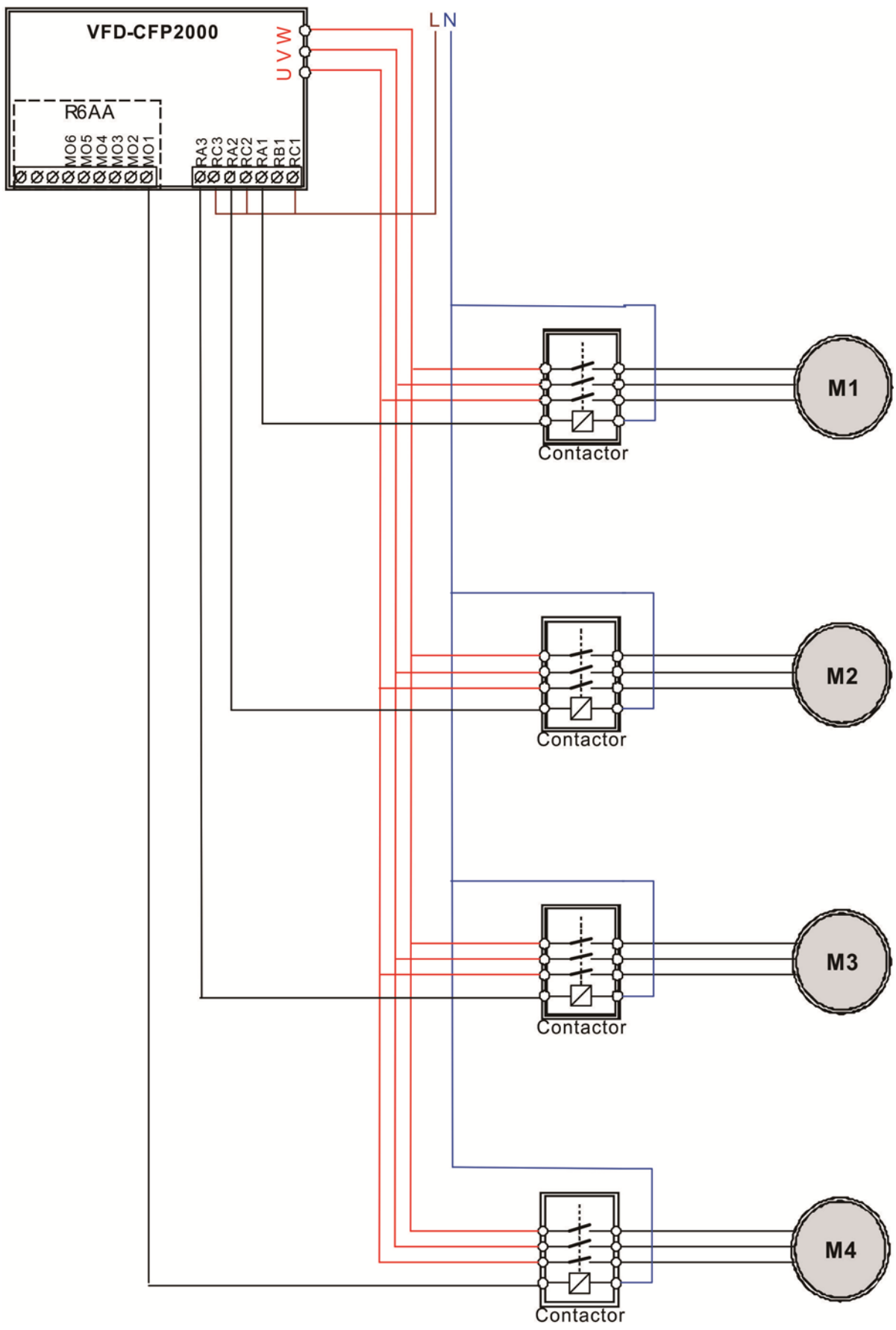

Diagram 12-2: Wiring

12-01 Number of Motors to be connected

Factory Setting: 1

Settings 1 to 8

Number of Motors: Maximum 8 motors. After setting number of motor to be connected at the same time, multi-function output terminals will follow automatically the setting as shown in the table below.

P12-01	01	02	03	04	05	06	07	08
P02-13	55	55	55	55	55	55	55	55
P02-14		56	56	56	56	56	56	56
P02-15			57	57	57	57	57	57
P02-36				58	58	58	58	58
P02-37					59	59	59	59
P02-38						60	60	60
P02-39							61	61
P02-40								62

Table 1: Setting of Multi-function Output Terminal on Circulating Motors

12-02 Operating time of each motor (minutes)

Factory Setting: 0

Settings 0 to 65500 minutes

 Setting of Fixed Time Circulation by minute. If Pr12-02 = 0, that means stop timing, the current running motors will keep on operating until a stop command is given.

12-03 Delay Time due to the Acceleration (or the Increment) at Motor Switching (seconds)

Factory Setting: 10

Settings 0.0 to 3600.0 seconds

 Delay time when switching motors in seconds. When the current running motors reach the time setting of Pr12-02, CFP2000 will follow the delay time setting of Pr12-03 and then switch to run the next motors.

12-04 Delay Time due to the Deceleration (or the Decrement) at Motor Switching (seconds)

Factory Setting: 10

Settings 0.0 to 3600.0 seconds

 **12-05** Delay time while fixed quantity circulation at Motor Switching (seconds)

Factory Setting: 100

Settings 0.0 to 3600.0 seconds

 **Fixed quantity circulation with PID**
Sequential Diagram

In this mode, CFP2000 can control up to 4 motors to increase controlling flow quantity and pressure range. When controlling flow quantity, motors will be in parallel connection. When controlling pressure range, motors will be in series connection.

If need to increase flow quantity or pressure range, CFP2000 will increase first motor's pressure from 0Hz to the largest operating frequency. If output frequency reaches the frequency setting of

Pr12-06 and delay time of Pr12-05, then CFP2000 will delay the time setting of Pr12-03. Then CFP2000 will switch the motor to use mains electricity and delay the time setting of Pr12-03 to run next motor. If necessary, other motors will be activated in sequence. See sequential diagram of 12-3 and 12-4.

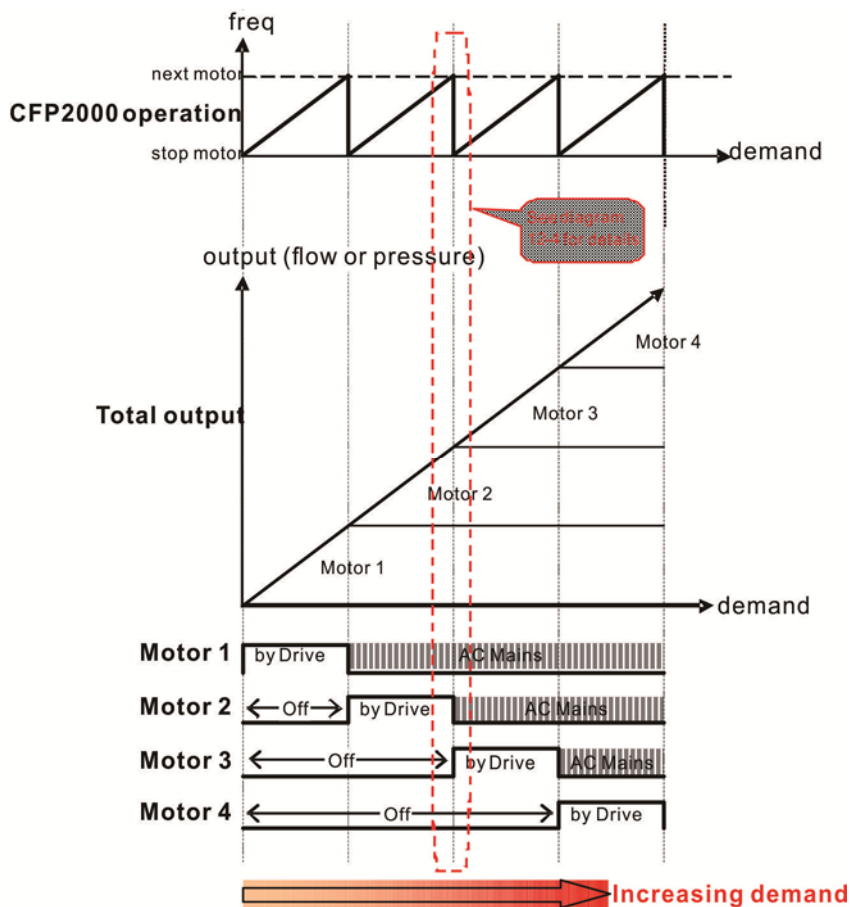

Diagram 12-3: Sequence of Fixed quantity circulation with PID – Increasing Demand

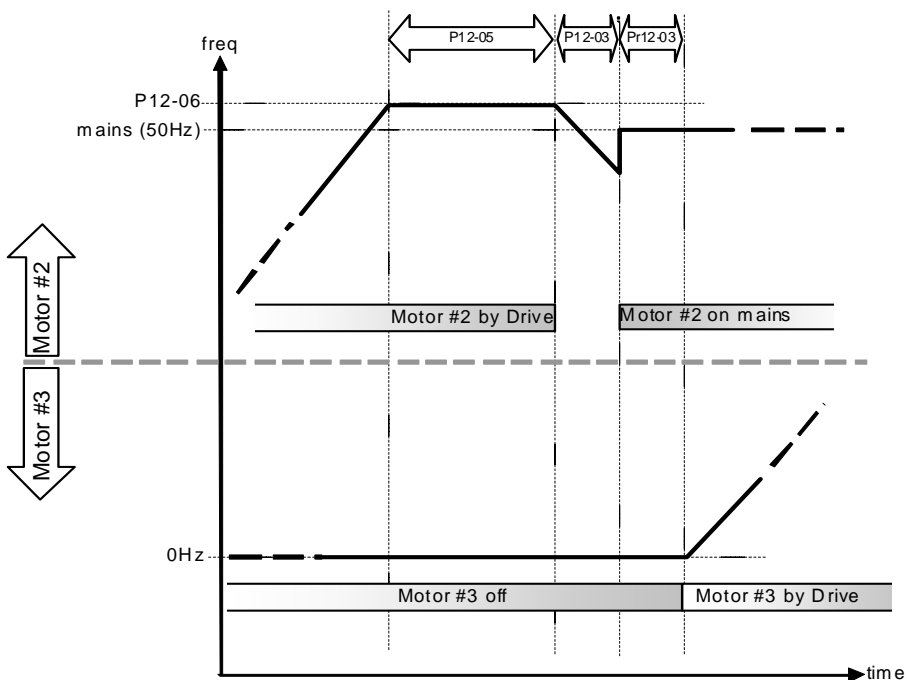

Diagram 12-4: Sequence of switching motors at fixed quantity circulation with PID – Increasing Demands

However if decreasing demands when flow quantity and pressure are too big, CFP2000 will stop the current operating motors and wait for the delay time setting of Pr12-04. Then keep on doing this until the last motor stop using mains electricity. See sequential diagram 12-5 and 12-6 below.

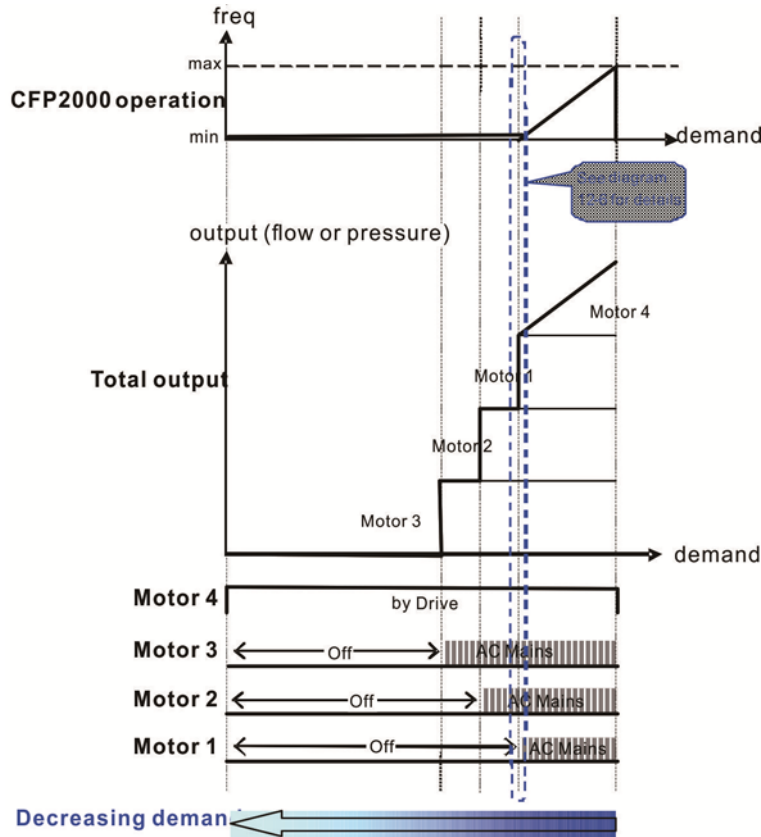

Diagram 12-5: Sequence of switching motors at fixed quantity circulation with PID – Decreasing Demands

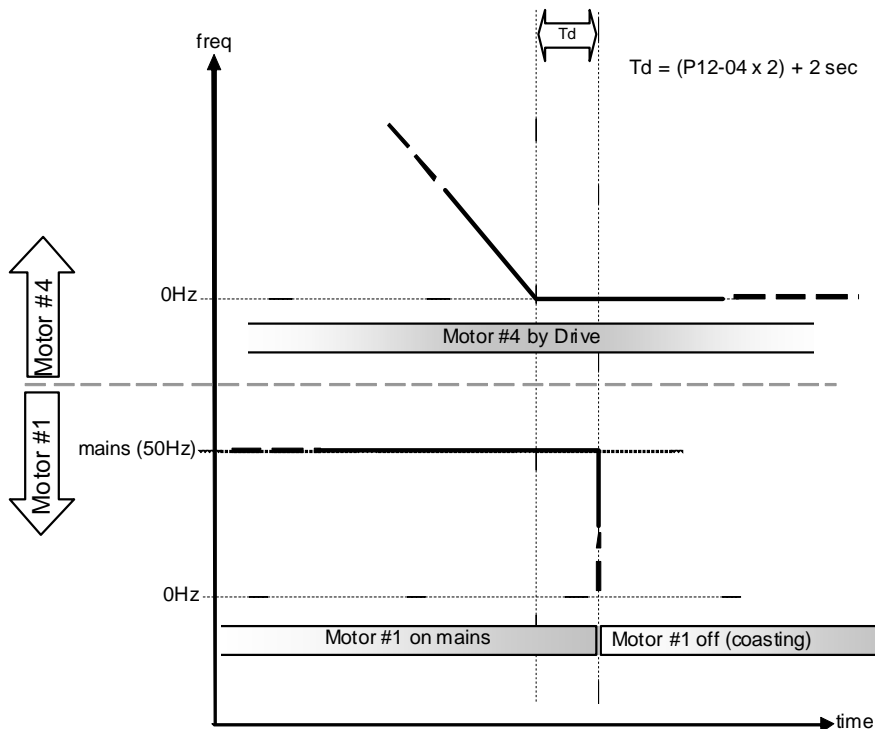

Diagram 12-6: Sequence of switching motors at fixed quantity circulation with PID – Decreasing Demands

 Parameter Setting

Parameter setting	Description																																																																																										
P12-00=2	Choose Fixed quantity circulation with PID																																																																																										
P12-01=X	<p>Number of Motors: Maximum 4 motors. After setting number of motor to be connected at the same time, multi-function output terminals will follow automatically the setting as shown in the table below.</p> <table border="1"> <tr> <td>P12-01</td> <td>01</td> <td>01</td> <td>02</td> <td>02</td> <td>03</td> <td>03</td> <td>04</td> <td>04</td> <td></td> </tr> <tr> <td>P02-13</td> <td>55</td> <td>55</td> <td>55</td> <td>55</td> <td>55</td> <td>55</td> <td>55</td> <td>55</td> <td>Motor #1 by Drive</td> </tr> <tr> <td>P02-14</td> <td></td> <td>56</td> <td>56</td> <td>56</td> <td>56</td> <td>56</td> <td>56</td> <td>56</td> <td>Motor #1 by Mains</td> </tr> <tr> <td>P02-15</td> <td></td> <td></td> <td>57</td> <td>57</td> <td>57</td> <td>57</td> <td>57</td> <td>57</td> <td>Motor #2 by Drive</td> </tr> <tr> <td>P02-36</td> <td></td> <td></td> <td></td> <td>58</td> <td>58</td> <td>58</td> <td>58</td> <td>58</td> <td>Motor #2 by Mains</td> </tr> <tr> <td>P02-37</td> <td></td> <td></td> <td></td> <td></td> <td>59</td> <td>59</td> <td>59</td> <td>59</td> <td>Motor #3 by Drive</td> </tr> <tr> <td>P02-38</td> <td></td> <td></td> <td></td> <td></td> <td></td> <td>60</td> <td>60</td> <td>60</td> <td>Motor #3 by Mains</td> </tr> <tr> <td>P02-39</td> <td></td> <td></td> <td></td> <td></td> <td></td> <td></td> <td>61</td> <td>61</td> <td>Motor #4 by Drive</td> </tr> <tr> <td>P02-40</td> <td></td> <td></td> <td></td> <td></td> <td></td> <td></td> <td></td> <td>62</td> <td>Motor #4 by Mains</td> </tr> </table> <p>Table 2: Setting of Multi-function Output Terminal on Circulating Motors</p>	P12-01	01	01	02	02	03	03	04	04		P02-13	55	55	55	55	55	55	55	55	Motor #1 by Drive	P02-14		56	56	56	56	56	56	56	Motor #1 by Mains	P02-15			57	57	57	57	57	57	Motor #2 by Drive	P02-36				58	58	58	58	58	Motor #2 by Mains	P02-37					59	59	59	59	Motor #3 by Drive	P02-38						60	60	60	Motor #3 by Mains	P02-39							61	61	Motor #4 by Drive	P02-40								62	Motor #4 by Mains
P12-01	01	01	02	02	03	03	04	04																																																																																			
P02-13	55	55	55	55	55	55	55	55	Motor #1 by Drive																																																																																		
P02-14		56	56	56	56	56	56	56	Motor #1 by Mains																																																																																		
P02-15			57	57	57	57	57	57	Motor #2 by Drive																																																																																		
P02-36				58	58	58	58	58	Motor #2 by Mains																																																																																		
P02-37					59	59	59	59	Motor #3 by Drive																																																																																		
P02-38						60	60	60	Motor #3 by Mains																																																																																		
P02-39							61	61	Motor #4 by Drive																																																																																		
P02-40								62	Motor #4 by Mains																																																																																		
P12-03=X	Delay Time due to the Acceleration (or the Increment) at Motor Switching (unit: second)																																																																																										
P12-04=X	Delay Time due to the Deceleration (or the Decrement) at Motor Switching (unit: sec)																																																																																										
P12-05=X	Delay time while fixed quantity circulation at Motor Switching with PID (unit: seconds)																																																																																										
P12-06=X	Frequency when switching motors at fixed quantity circulation (Hz)																																																																																										

 **Disable Motor Output**

Set the Multifunction Input Commands as Disable Motors' Output can stop corresponding motors.

The settings are:

P02-01~P02-06=	60	61	62	63	64	65	66	67	68
Disable Motor Output	ALL	1	2	3	4	5	6	7	8

When a motor's output is disabled, this motor will park freely

Fixed quantity circulation with PID can control up to 4 motors. The Diagram 12-7 below is an example of controlling 4 motors.

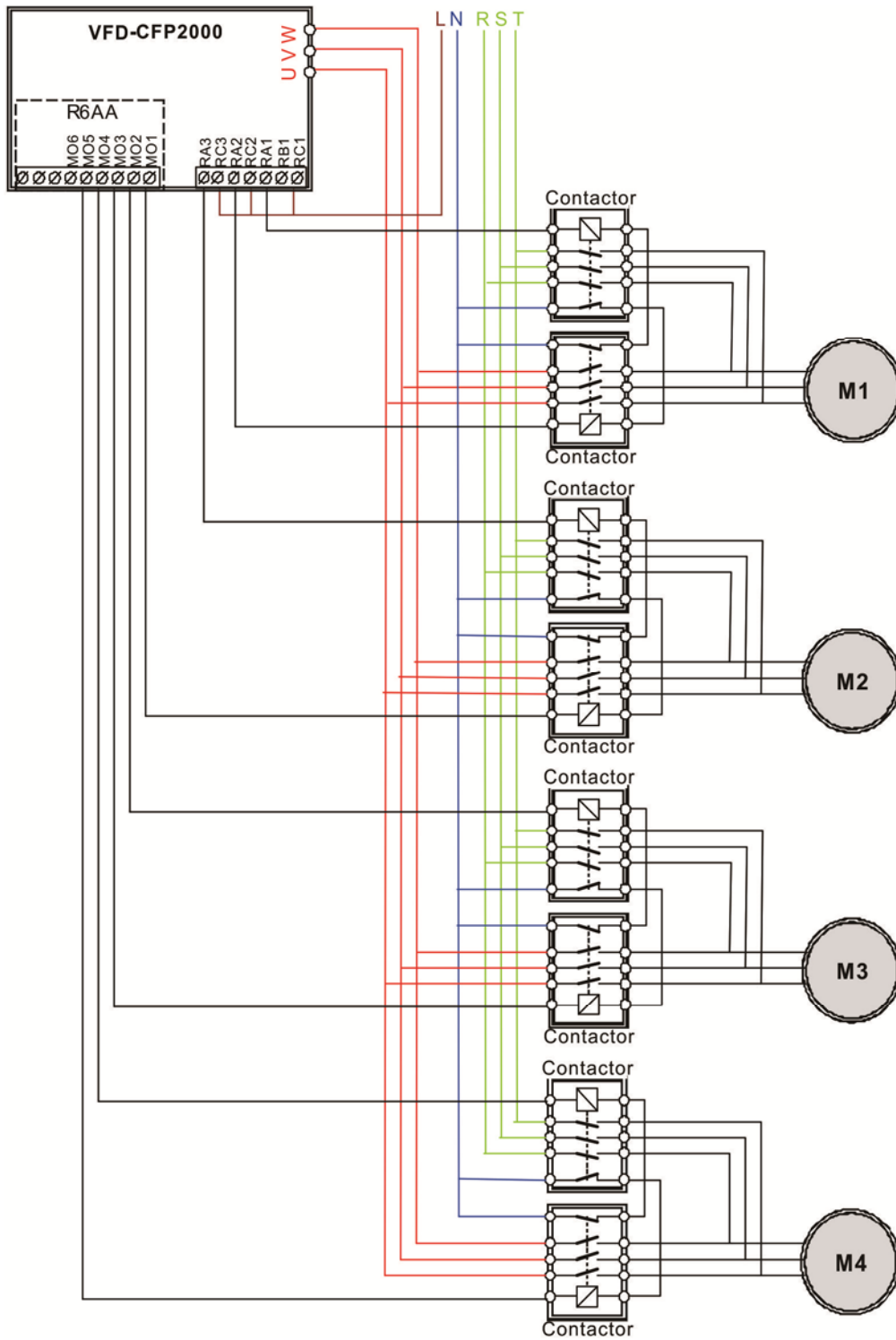

Diagram 12-7

12-06 Frequency Point when switch from I/F Sensorless Observation mode to V/F mode

Factory Setting: 6000

Settings 0.0 to 600.00 Hz

When the drive's output frequency reaches the setting value of Pr12-06, the system will start preparing to switch motors.

12-07 I/F mode, low pass-filter time

Factory Setting: 0

Settings 0: Turn off all output

1: Motors powered by mains electricity continues to operate

12-08 Initial Angle Detection Time

Factory Setting: 0

Settings 0.00 to 600.00 Hz

When the output frequency is smaller than the setting value of Pr12-08 and remains at the time setting of Pr12-04, motors will be shut down one by one.

Fixed quantity control with PID

In this mode, CFP2000 can control up to 8 motors to increase controlling flow quantity and pressure range.

CFP2000 connects directly to a main motor while the rest of motors are using mains electricity and controlled by a relay. When controlling flow quantity, motors will be in parallel connection. When controlling pressure range, motors will be in series connection

If need to increase flow quantity or pressure range, CFP2000 will increase the main motor's pressure from 0Hz to the largest operating frequency. If necessary, CFP2000 will switch in sequence the motors to use mains electricity. See sequential diagram of 12-8 and 12-9.

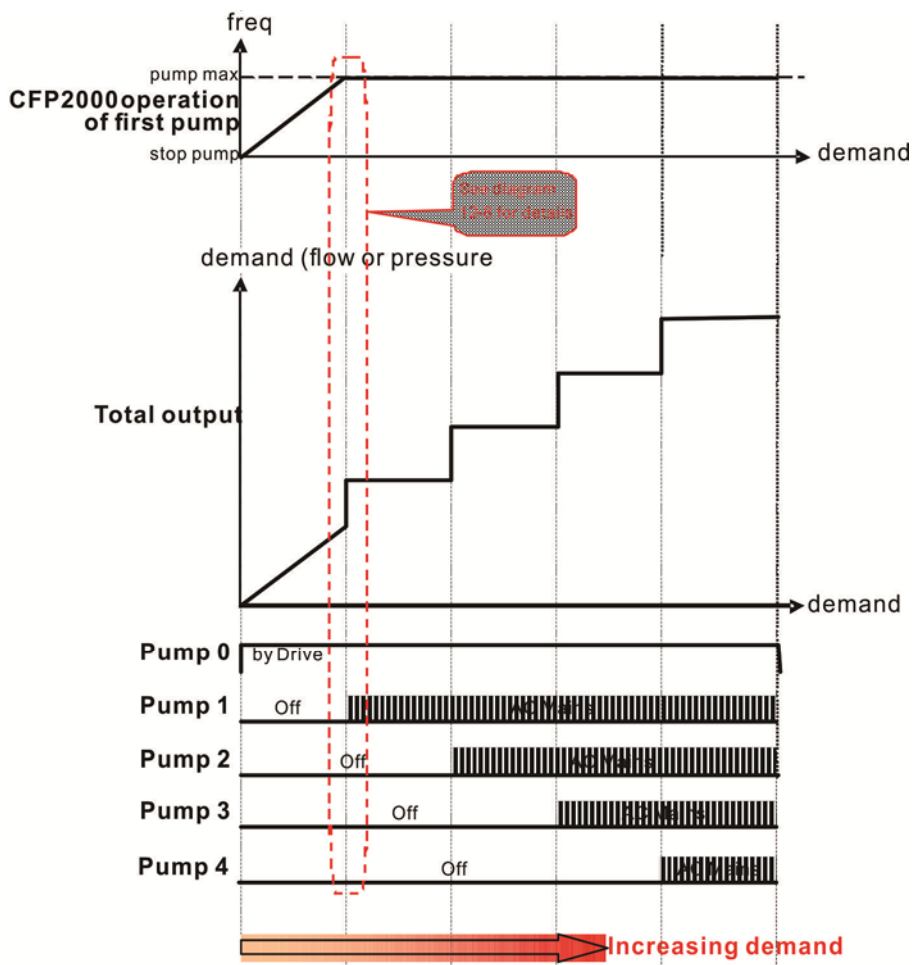

Diagram 12-8: Fixed quantity control with PID – Increasing Demand

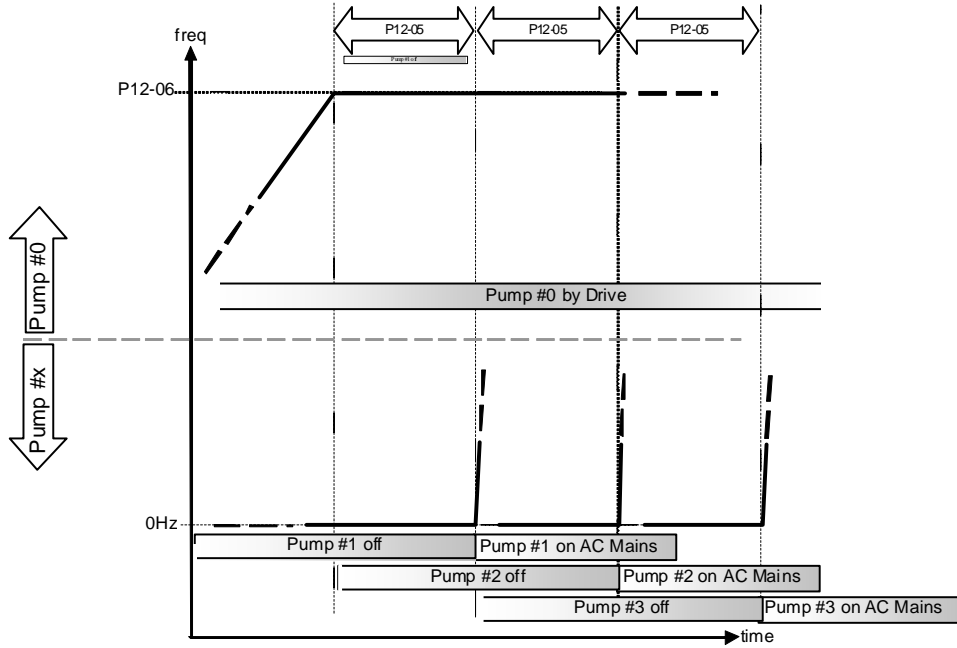

Diagram 12-9: Sequence of switching motors at fixed quantity control with PID – Increasing Demand

However, if the flow quantity or pressure is too big, CFP2000 will stop, one by one, the motors from using mains electricity until CFP2000 decrease the main motor's frequency to 0Hz. See diagram 12-10 and diagram 12-11.

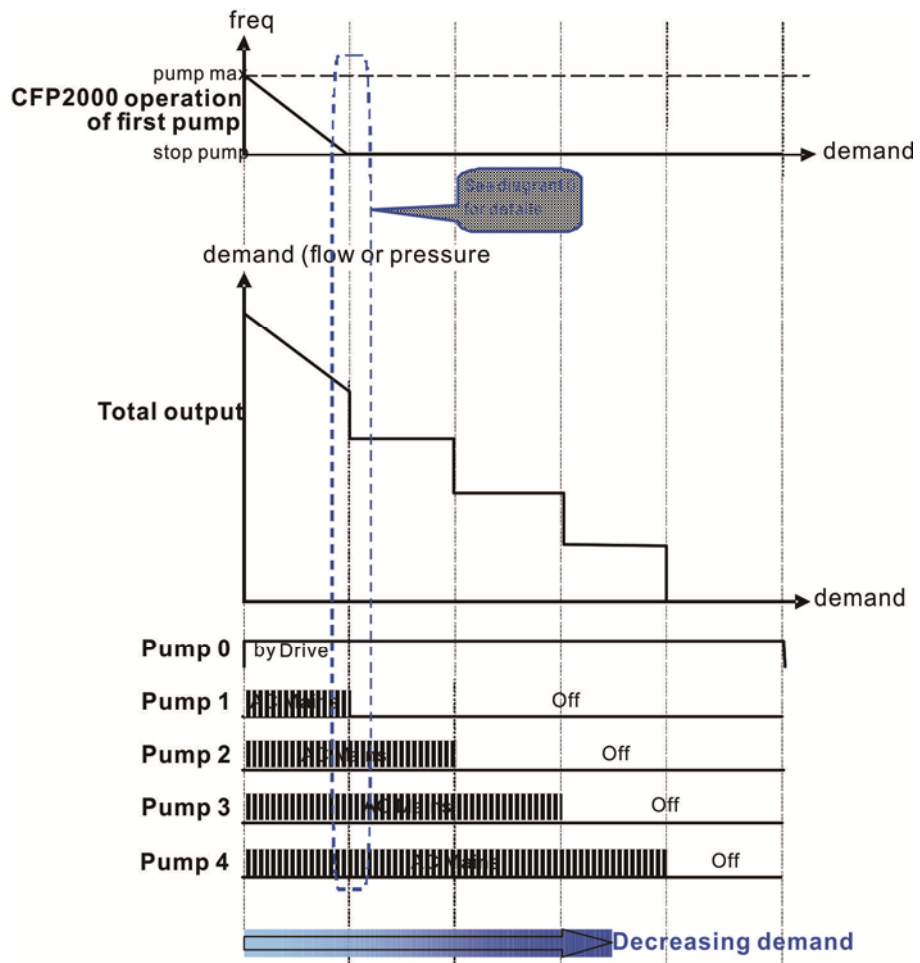

Diagram 12-10: Sequence of switching motors at fixed quantity control with PID – Decreasing Demand

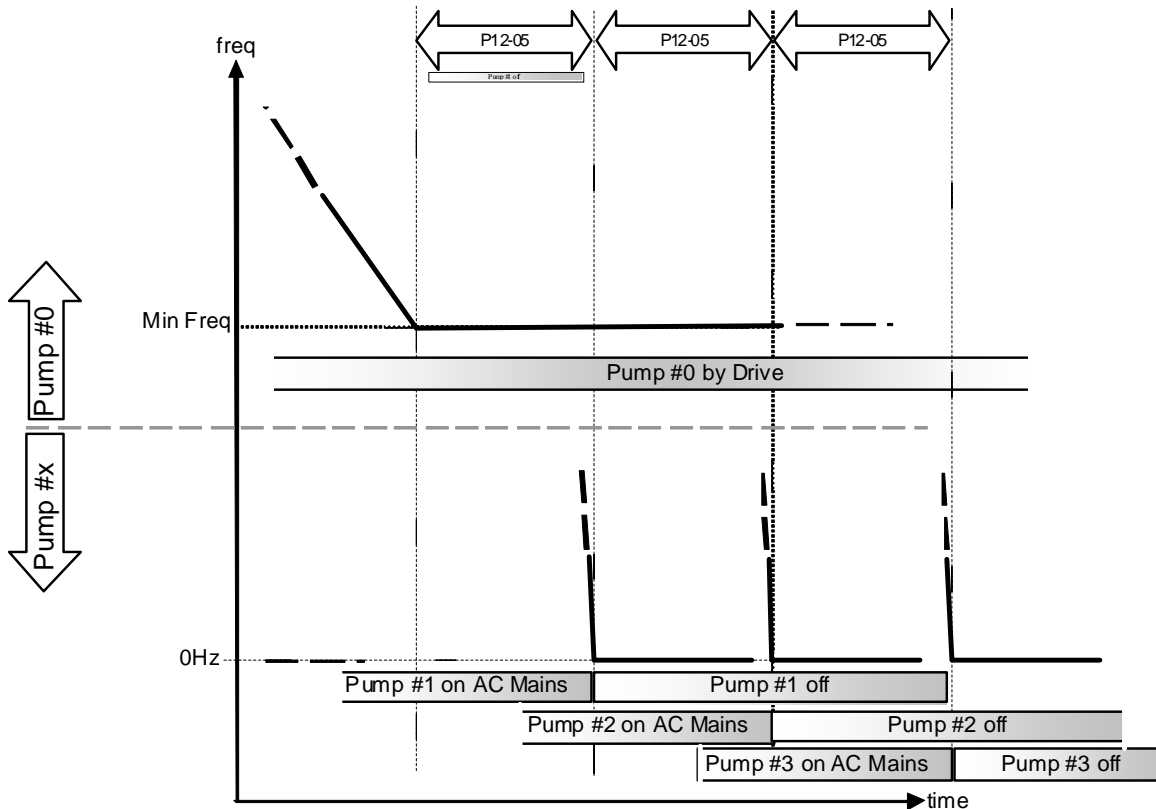

Diagram 12-10: Sequence of switching motors at fixed quantity control with PID – Decreasing Demand

Parameter Setting	Description																																																																																										
P12-00=3	Choose Fixed quantity control																																																																																										
P12-01=X	Number of Motors: Maximum 8 motors. After setting number of motor to be connected at the same time, multi-function output terminals will follow automatically the setting as shown in the table below. <table border="1" style="margin: 10px auto; width: 80%;"> <thead> <tr> <th>P12-01</th> <th>01</th> <th>02</th> <th>03</th> <th>04</th> <th>05</th> <th>06</th> <th>07</th> <th>08</th> <th></th> </tr> </thead> <tbody> <tr> <td>P02-13</td> <td>55</td> <td>55</td> <td>55</td> <td>55</td> <td>55</td> <td>55</td> <td>55</td> <td>55</td> <td>Motor #1 by Mains</td> </tr> <tr> <td>P02-14</td> <td></td> <td>56</td> <td>56</td> <td>56</td> <td>56</td> <td>56</td> <td>56</td> <td>56</td> <td>Motor #2 by Mains</td> </tr> <tr> <td>P02-15</td> <td></td> <td></td> <td>57</td> <td>57</td> <td>57</td> <td>57</td> <td>57</td> <td>57</td> <td>Motor #3 by Mains</td> </tr> <tr> <td>P02-36</td> <td></td> <td></td> <td></td> <td>58</td> <td>58</td> <td>58</td> <td>58</td> <td>58</td> <td>Motor #4 by Mains</td> </tr> <tr> <td>P02-37</td> <td></td> <td></td> <td></td> <td></td> <td>59</td> <td>59</td> <td>59</td> <td>59</td> <td>Motor #5 by Mains</td> </tr> <tr> <td>P02-38</td> <td></td> <td></td> <td></td> <td></td> <td></td> <td>60</td> <td>60</td> <td>60</td> <td>Motor #6 by Mains</td> </tr> <tr> <td>P02-39</td> <td></td> <td></td> <td></td> <td></td> <td></td> <td></td> <td>61</td> <td>61</td> <td>Motor #7 by Mains</td> </tr> <tr> <td>P02-40</td> <td></td> <td></td> <td></td> <td></td> <td></td> <td></td> <td></td> <td>62</td> <td>Motor #8 by Mains</td> </tr> </tbody> </table> Table 2: Setting of Multi-function Output Terminal on Circulating Motors	P12-01	01	02	03	04	05	06	07	08		P02-13	55	55	55	55	55	55	55	55	Motor #1 by Mains	P02-14		56	56	56	56	56	56	56	Motor #2 by Mains	P02-15			57	57	57	57	57	57	Motor #3 by Mains	P02-36				58	58	58	58	58	Motor #4 by Mains	P02-37					59	59	59	59	Motor #5 by Mains	P02-38						60	60	60	Motor #6 by Mains	P02-39							61	61	Motor #7 by Mains	P02-40								62	Motor #8 by Mains
P12-01	01	02	03	04	05	06	07	08																																																																																			
P02-13	55	55	55	55	55	55	55	55	Motor #1 by Mains																																																																																		
P02-14		56	56	56	56	56	56	56	Motor #2 by Mains																																																																																		
P02-15			57	57	57	57	57	57	Motor #3 by Mains																																																																																		
P02-36				58	58	58	58	58	Motor #4 by Mains																																																																																		
P02-37					59	59	59	59	Motor #5 by Mains																																																																																		
P02-38						60	60	60	Motor #6 by Mains																																																																																		
P02-39							61	61	Motor #7 by Mains																																																																																		
P02-40								62	Motor #8 by Mains																																																																																		
P12-05=X	Delay time while fixed quantity circulation at Motor Switching (seconds)																																																																																										
P12-06=X	Frequency when switching motors at fixed quantity circulation (Hz)																																																																																										

Disable Motor’s Output

Set the Multifunction Input Commands as Disable Motors’ Output can stop corresponding motors. The settings are: :

P02-01~P02-06=	60	61	62	63	64	65	66	67	68
Disable Motor's Output	ALL	1	2	3	4	5	6	7	8

When a motor's output is disabled, this motor will park freely

Wiring: Fixed Quantity Control can control up to 8 motors. The diagram 12-12 is an example of controlling 4 motors at the same time.

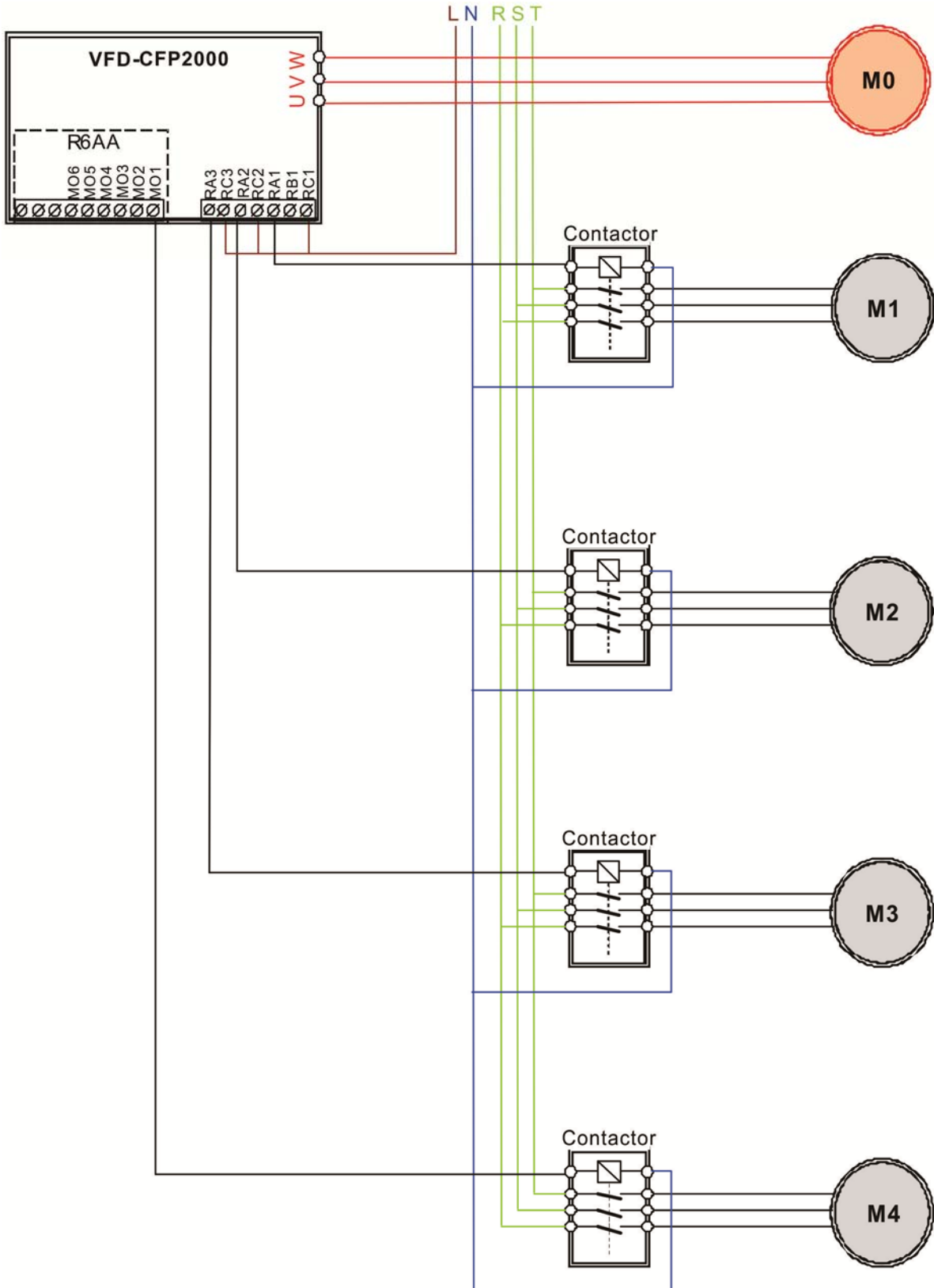

Diagram 12-12

Fixed Time circulation and Fixed quantity circulation with PID

This mode combines Fixed Time circulation and fixed quantity circulation with PID. It is to prevent motors to become rusty if they are not in use for a long period of time. If some motors are not activated, set the fixed time circulation to run motors one by one to make sure each of them has the chance to run.

While all the motors are running and water pressure is enough, the time circulation will not be enabled. Suppose that motor1 and motor2 run to reach a balance in water pressure and when the time reaches the setting at Pr12-02, the motor1 will be running without using mains electricity and the motor2 will decelerate to stop.

When the motor2 reaches the frequency setting at Pr12-06 and the time setting at Pr12-05, it will be separating from the motor drive. Then when time reaches the setting at Pr12-03, the motor2 will run by using the mains electricity. Then when the time passes the setting at Pr12-03, the motor3 will be enabled by the motor drive. The time sequence diagram is as shown below.

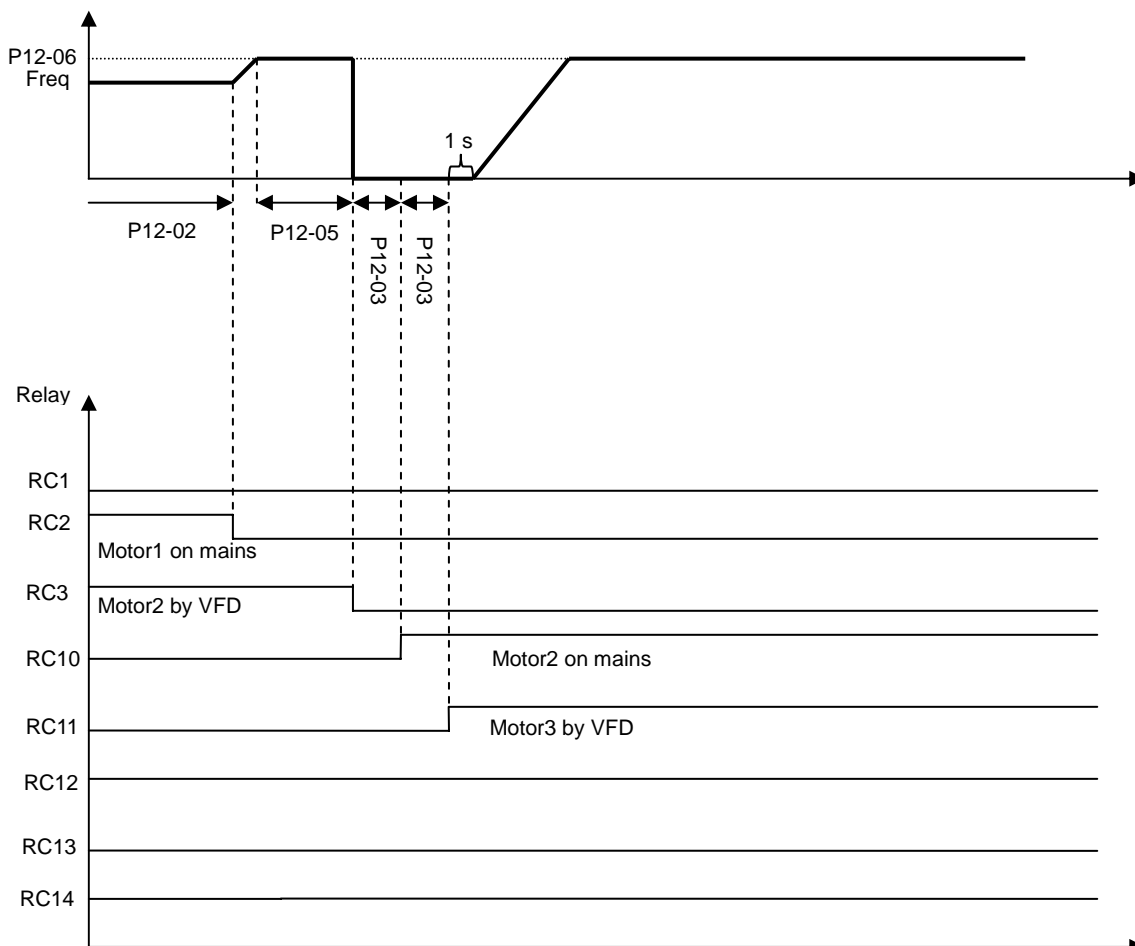

Fixed Time Circulation and Fixed Quantity Control with PID

 Time circulation and Fixed amount control with PID

This mode combines Fixed Time circulation and fixed quantity control with PID. It is to prevent motors to become rusty if they are not in use for a long period of time. If some motors are not activated, set the fixed time circulation to run motors one by one to make sure each of them has the chance to run.

When all the motors are running and water pressure is enough, the fixed time circulation will not be enabled. Suppose that the motor1 and motor2 run to reach a balance in water pressure and when time reach the setting at Pr12-02, the motor1 will be running without using mains electricity. Then when time reaches the setting at Pr12-03, the motor3 will be running by using mains electricity. At this moment, the operating time of each motor will be reset, once reach the time setting at Pr12-02 again, the motor2 will be running without using mains electricity. Then when time reaches the setting at Pr12-03, the fourth motor4 will be running by using mains electricity. The time sequence diagram 12-14 is as shown below

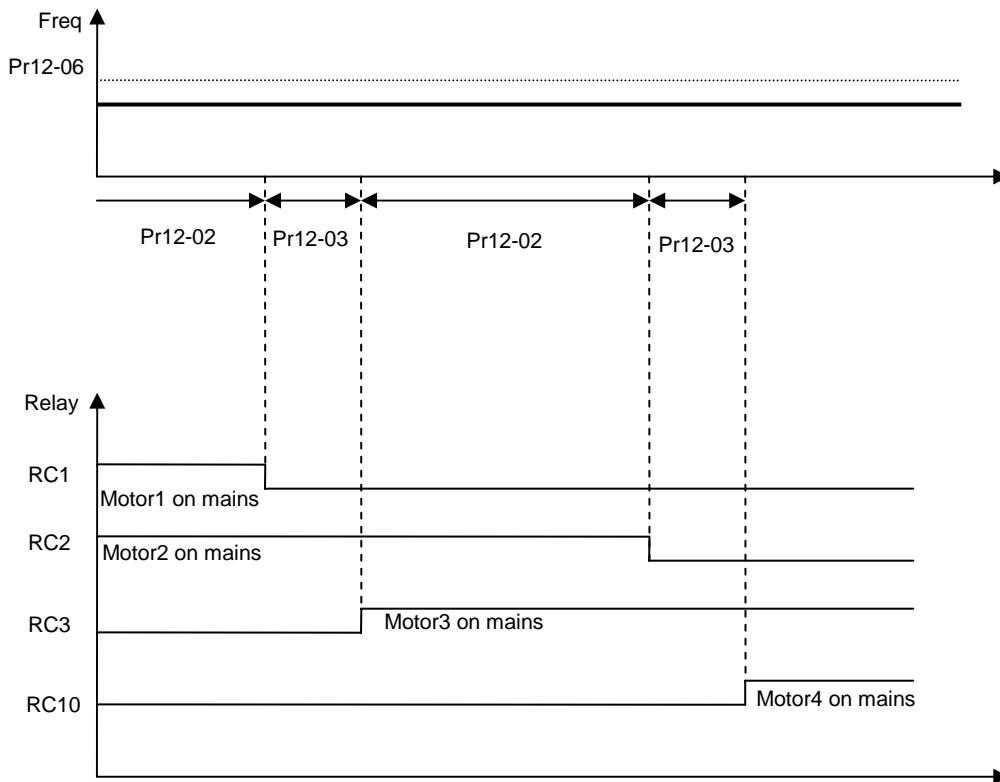

Diagram 12-14: Enabling Fixed Time Circulation under Fixed Amount Control Balance

13 Application Parameters by Industry

✎ This parameter can be set during operation.

13-00 Application selection

Factory Setting: 0

Settings 0: Disabled
1: User Parameter
2: Compressor IM
3: Fan
4: Pump



Settings:

2: Compressor IM

Pr	Explanation	Settings
00-11	Control of Speed Mode	0: VF (IM V/F control)
00-16	Load Selection	0: Light load
00-17	Carrier Frequency	#. #
00-20	Source of Master Frequency Command (AUTO)	2: External analog input (Pr.03-00)
00-21	Source of the Operation Command (AUTO)	1: External terminals. Keypad STOP disabled.
00-22	Stop Method	0: Ramp to stop
00-23	Control of Motor Direction	1: Reverse disable
01-00	Max. Operation Frequency	60.00/ 50.00
01-01	Output Frequency of Motor 1	60.00/ 50.00
01-02	Output Voltage of Motor 1	400.0
01-03	Mid-point Frequency 1 of Motor 1	3.00
01-04	Mid-point Voltage 1 of Motor 1	22.0
01-05	Mid-point Frequency 2 of Motor 1	1.50
01-06	Mid-point Voltage 2 of Motor 1	10.0
01-07	Min. Output Frequency of Motor 1	0.50
01-08	Min. Output Voltage of Motor 1	2.0
01-11	Output Frequency Lower Limit	20 (Hz)
01-12	Accel. Time 1	20 (s)
01-13	Decel Time 1	20 (s)
03-00	Analog Input Selection (AVI)	0: No function
03-01	Analog Input Selection (ACI)	1: Frequency command (speed limit under torque control mode)
05-01	Full-load Current of Induction Motor 1(A)	###
05-03	Rated Speed of Induction Motor 1 (rpm)	1710
05-04	Pole Number of Induction Motor 1	4

3: Fan

Pr	Explanation	Settings
00-11	Control of Speed Mode	0 (VF)
00-16	Load Selection	1: Normal load
00-17	Carrier Frequency	##
00-20	Source of Master Frequency Command (AUTO)	2: External analog input (Pr.03-00)
00-21	Source of the Operation Command (AUTO)	1: External terminals. Keypad STOP disabled.
00-22	Stop Method	1: Coast to stop
00-23	Control of Motor Direction	1: Coast to stop
00-30	Source of the Master Frequency Command (HAND)	0: Digital keypad
00-31	Source of the Operation Command (HAND)	0: Digital keypad
01-00	Max. Operation Frequency	60.00/ 50.00
01-01	Output Frequency of Motor 1	60.00/ 50.00
01-02	Output Voltage of Motor 1	400.0
01-03	Mid-point Frequency 1 of Motor 1	3.00
01-04	Mid-point Voltage 1 of Motor 1	22.0
01-05	Mid-point Frequency 2 of Motor 1	1.50
01-06	Mid-point Voltage 2 of Motor 1	10.0
01-07	Min. Output Frequency of Motor 1	0.50
01-08	Min. Output Voltage of Motor 1	2.0
01-10	Output Frequency Upper Limit	50 (Hz)
01-11	Output Frequency Lower Limit	35 (Hz)
01-12	Accel. Time 1	15 (s)
01-13	Decel Time 1	15 (s)
01-43	V/f Curve Selection	2: 2 nd V/F curve
02-05	Multi-function Input Command 5 (MI5)	16: Operation speed command from ACI
03-00	Analog Input Selection (AVI1)	1: Frequency command (speed limit under torque control mode)
03-01	Analog Input Selection (ACI)	1: Frequency command (speed limit under torque control mode)
03-28	AVI1 Selection	0 (0~10 V)
03-29	ACI Selection	1 (0~10 V)
03-31	AFM2 Output Selection	0 (0~10 V)
03-50	Analog Input Curve Selection	1: 3 point curve of AVI1
07-06	Restart after Momentary Power Loss	2: Speed search for minimum output frequency
07-11	Number of Times of Auto Restart After Fault	5
07-33	Auto restart interval of Fault	60 (s)

4: Pump

Pr	Explanation	Settings
00-11	Control of Speed Mode	0 (VF)
00-16	Load Selection	1: Normal load
00-20	Carrier Frequency	2: External analog input (Pr.03-00)
00-21	Source of Master Frequency Command (AUTO)	1: External terminals. Keypad STOP disabled.
00-23	Source of the Operation Command (AUTO)	1: Reverse disable
01-00	Max. Operation Frequency	60.00/ 50.00
01-01	Output Frequency of Motor 1	60.00/ 50.00
01-02	Output Voltage of Motor 1	400.0
01-03	Mid-point Frequency 1 of Motor 1	3.00
01-04	Mid-point Voltage 1 of Motor 1	22.0
01-05	Mid-point Frequency 2 of Motor 1	1.50
01-06	Mid-point Voltage 2 of Motor 1	10.0
01-07	Min. Output Frequency of Motor 1	0.50
01-08	Min. Output Voltage of Motor 1	2.0
01-10	Output Frequency Upper Limit	50 (Hz)
01-11	Output Frequency Lower Limit	35 (Hz)
01-12	Accel. Time 1	15 (s)
01-13	Decel Time 1	15 (s)
01-43	V/f Curve Selection	2: 2 nd V/F curve
07-06	Restart after Momentary Power Loss	2: Speed search for minimum output frequency
07-11	Number of Times of Auto Restart After Fault	5
07-33	Auto restart interval of Fault	60 (s)

13-01

~

Application Parameter 1~99

13-99

12-2 Adjustment & Application

12-2-1 Standard PM Motor Adjustment Procedure

- Pr00-11=2 SVC (Pr05-33=1 or 2)

Flow chart of adjustment when starting up WITHOUT load

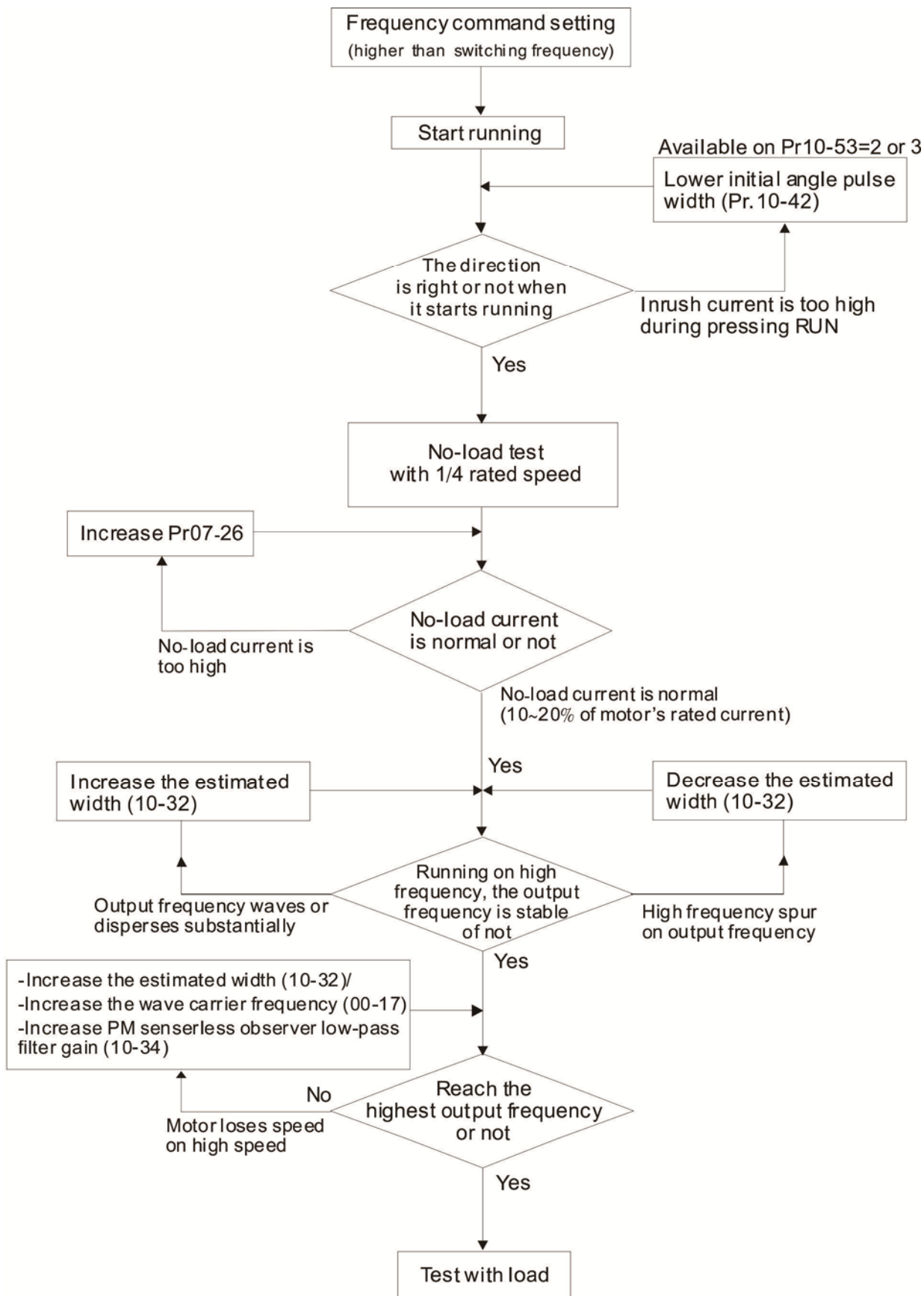

Flow chart of adjustment when starting up WITH load

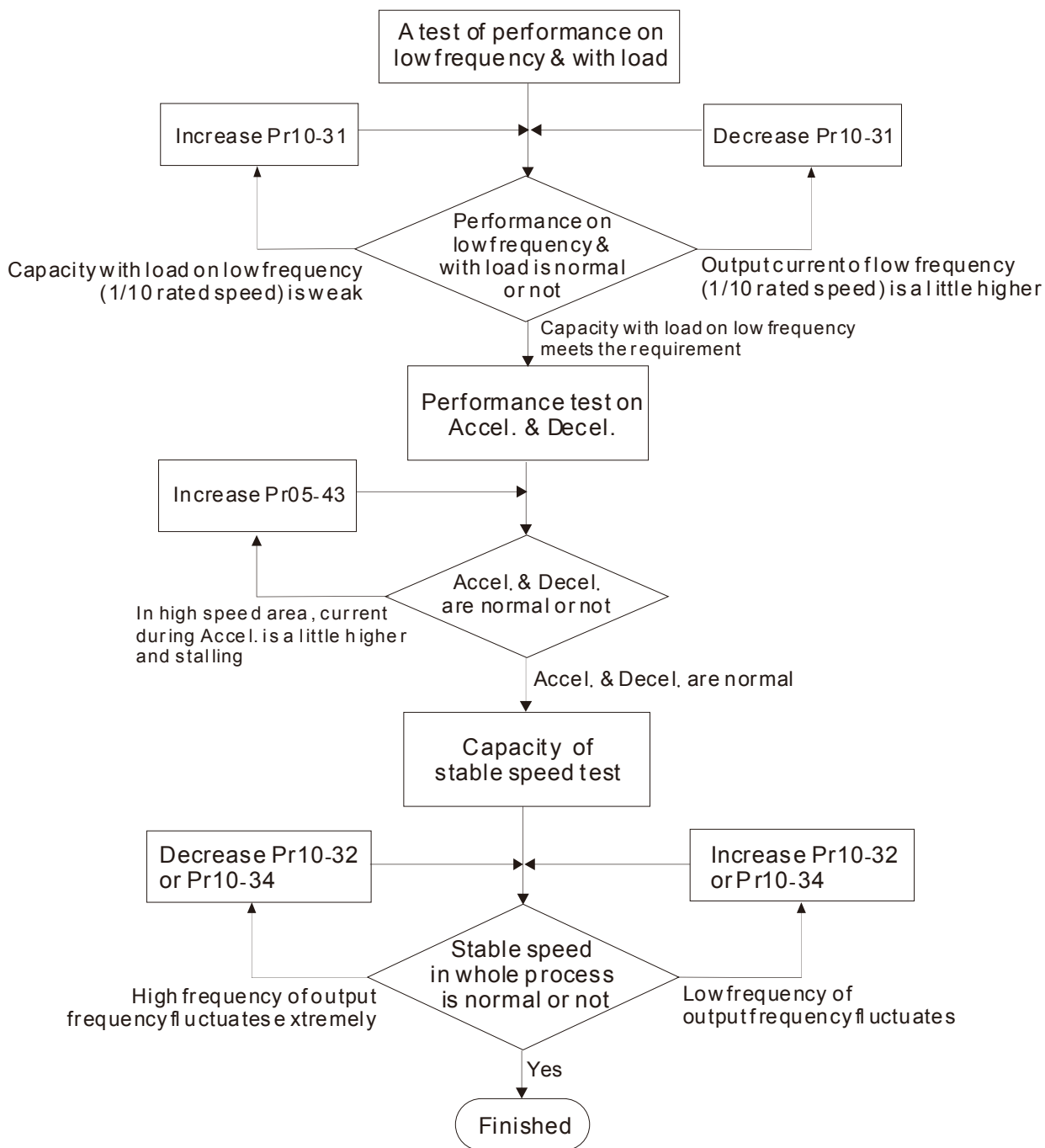

PMSVC control diagram

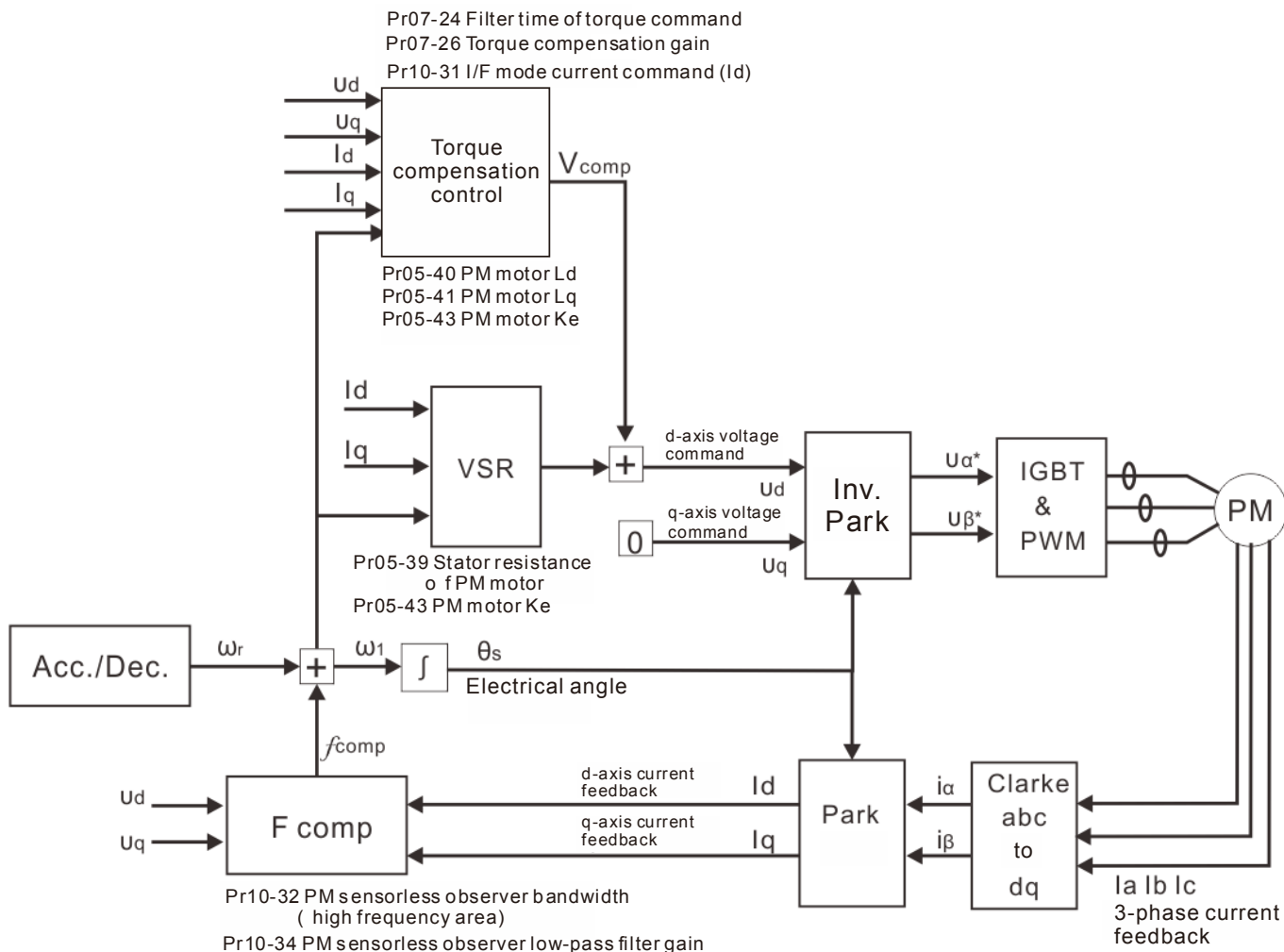

Adjustment procedure

1. Set up PM motor control

Pr05-33=1 or 2

2. Set up motor parameter according to the nameplate on the motor

Pr01-01 Output Frequency of Motor 1 (base frequency and motor rated frequency)

Pr01-02 Output Voltage of Motor 1 (base frequency and motor rated frequency)

Pr05-34 Full-load current of Permanent Magnet Motor

Pr05-35 Rated Power of Permanent Magnet Motor

Pr05-36 Rated speed of Permanent Magnet Motor

Pr05-37 Pole number of Permanent Magnet Motor

3. Execute Auto-tuning

Set up Pr05-00=13 for IPM motor tuning and press Run(static-tuning). When the tuning is done, the following parameters will be obtained.

Pr05-39 Stator Resistance of PM Motor

Pr05-40 Permanent Magnet Motor L_d Pr05-41 Permanent Magnet Motor L_q

Pr05-43 (V/1000rpm), the K_e parameter of PM motor (this can be calculated automatically according to power, current and speed of motor).

Pr10-52 Injection magnitude

4. Set up speed control mode: Pr00-10=0, Pr00-11=2 SVC.
5. It is suggested that cutting off the power after finishing tuning, and then re-power on.
6. The ration of PMSVC control mode is 1:20.
7. When PMSVC control mode is under 1/20 rated speed, load bearing capacity=100% motor rated torque.
8. PMSVC control mode is not applicable for zero speed control.
9. Start-up with load and forward/reverse load bearing capacity of PMSVC control mode=100% rated torque of motor.
10. Set up the speed estimators related parameters

➤ **10-31** I/F Mode Current Command / Low-speed Current Command under PMSVC Control

Factory Setting:40

Settings 0~150% of motor's rated current

- 📖 The parameter is the current command of the drive in low-speed area (low-speed area: frequency command < Pr10-39).
- 📖 When it is stalling on heavy duty start-up or forward/reverse with load, adjust the parameter (to increase it). If inrush current too higher to cause oc stall, then decrease it.

➤ **10-32** PM FOC Sensorless Speed Estimator Bandwidth

Factory Setting:5.00

Settings 0.00~600.00Hz

- 📖 The parameter is speed estimator bandwidth. Adjust the parameter will influence the stability and the accuracy of speed for motor.
- 📖 If there is low frequency vibrates (the waveform is similar to sine wave) during the process, then increase the bandwidth. If there is high frequency vibrates (the waveform vibrates extremely and is like spur), then decrease the bandwidth.

➤ **10-34** PM Sensorless Observer Low-pass Filter Gain

Factory Setting:1.00

Settings 0.00~655.35

- 📖 Adjust the parameter will influence the speed estimator's speed of response.
- 📖 If there is low frequency vibrates (the waveform is similar to sine wave) during the process, then increase the gain. If there is high frequency vibrates (the waveform vibrates extremely and is like spur), then decrease the gain.

➤ **10-39** Frequency Point when switch from I/F Mode to PM Sensorless Mode

Factory Setting:20.00

Settings 0.00~599.00Hz

- 📖 The parameter is the switch point which is from low frequency to high frequency. It will influence high/low frequency area of speed observer.
- 📖 If the switch point is too low, motor will generate not enough back emf to let the speed estimator measure the right rotator's position and speed, and cause stall and oc when the frequency of switch point is running.

- 📖 If the switch point is too high, the active area of I/F will too wide, and then it will generate larger current to make it cannot save energy. (The reason is that if the current of Pr10-31 sets too high, and the high switch point will make the drive keeps outputting with the setting value of Pr10-31)

⚡ 10-42 Voltage pulse width

Factory Setting: 10

Settings 0~50 ms

- 📖 The angle detection is 3:6-pulse. The parameter influences the value of pulse during the angle detection. The larger the pulse is, the higher of the accuracy of rotator's position. But it might cause oc easily.
- 📖 Increase the parameter when the running direction and the command are opposite while start-up. If oc occurs in the start-up moment, then decrease the parameter.

⚡ 10-49 Zero voltage time while start up

Factory Setting: 0.000

Settings 0.000~60.000 sec.

- 📖 When the motor is in static status at the startup, the accuracy to estimate angles will be increased. In order to make the motor in "static status", the drive 3 phase U, V, W output 0V to motor to reach this goal. The Pr10-49 setting time is the length of time when three-phase output 0V.
- 📖 It is possible that even when this parameter is being applied but the motor at the installation site cannot go in to the "static status" caused by the inertia or by any external force. So, if the motor doesn't go into a completer "static status" in 0.2 sec, increase appropriately this setting value.
- 📖 This parameter is functional only when the setting of Pr07-12 Speed Search during Startup $\neq 0$.
- 📖 If Pr10-49 sets too high, the start-up time will be longer obviously. If is too low, then the braking performance will be weak.

⚡ 10-51 Injection Frequency

Factory Setting: 500Hz





Settings 0~1200Hz

- 📖 This parameter is a High Frequency Injection Command when the motor drive is under IPM HFI sensor-less control mode and it doesn't often need to be adjusted. But, if a motor's rated frequency (i.e. 400Hz) is too close to the frequency setting of this parameter (i.e. 500Hz), the accuracy of angles detected will be affected. Therefore, refer to the setting of Pr01-01 before adjusting this parameter.
- 📖 If the setting value of Pr00-17 is lower $Pr10-51 * 10$, then increase the frequency of carrier wave.

⚡ 10-52 Injection Magnitude

Factory Setting: 15/30V

Settings 0.0~200.0V

-  The parameter is magnitude command of high frequency injection signal when IPM HFI sensorless control mode.
-  Increase the parameter can get the more accurate estimated value of angle. But the noise of electromagnetic might be louder if the setting value is too high.
-  To get the parameter when motor's parameter is "Auto". And the parameter will influence the accuracy of angel's estimation.
-  When the ratio of salient pole (Lq/Ld) is lower, increase Pr10-52 to make angle detection be accurate.

 **10-53** PM Motor Initial Rotor Position Detection Method

Factory Setting: 0

- Settings
- 0: No function
 - 1: DC injection
 - 2: High frequency injection
 - 3: Pulse injection
 - 4~5: Reserved



-  It is suggested to set as "2" if it's IPM; set as "3" if it's SPM. If there is bad effect when set as "2" or "3", then set as "1".

11. Parameters for speed adjustment

 **07-26** Torque Compensation Gain (V/F and SVC control mode)

Factory Setting: 0

Settings 0~10

-  The parameter influences the output current during the running process. There will be less effect on the low speed area.
-  Increase the setting value if the current with no-load is too high. But it might also cause the motor to vibrate. If the motor vibrates during the operation, decrease the setting value.



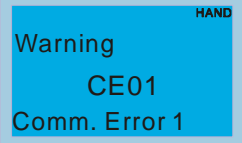
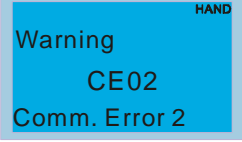
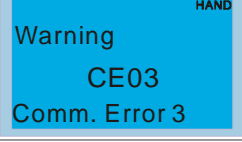
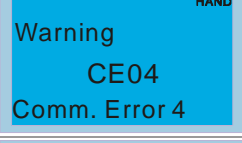
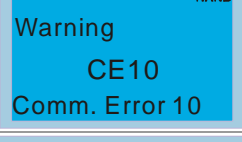
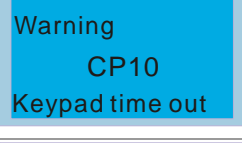
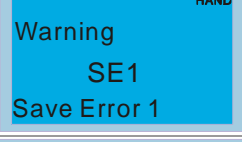
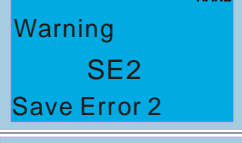
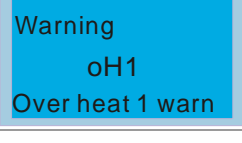

Chapter 13 Warning Codes



① Warning	① Display error signal
② CE01	② Abbreviate error code
③ Comm. Error 1	③ Display error description

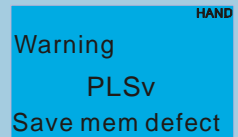
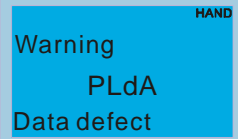
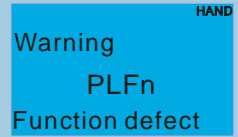
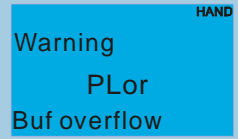

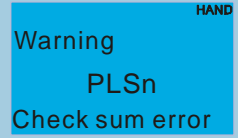
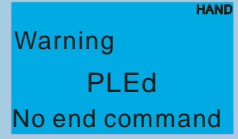
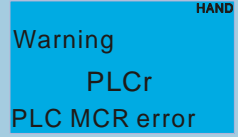
ID No.	Display on LCM Keypad	Descriptions
1		Modbus function code error
2		Address of Modbus data is error
3		Modbus data error
4		Modbus communication error
5		Modbus transmission time-out
6		Keypad transmission time-out
7		Keypad COPY error 1 Keypad simulation error, including communication delays, communication error (keypad received error FF86) and parameter value error.
8		Keypad COPY error 2 Keypad simulation done, parameter write error
9		IGBT over-heating warning

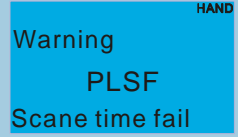
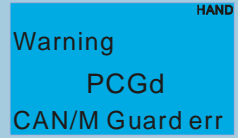
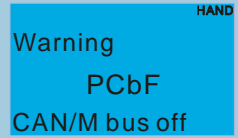
ID No.	Display on LCM Keypad	Descriptions
10		Capacity over-heating warning
11		PID feedback error
12		ACI signal error When Pr03-19 is set to 1 and 2.
13		Low current
14		Auto tuning error
19		Phase loss
20		Over torque 1
21		Over torque 2
22		Motor over-heating
24		Over slip
25		Auto tuning processing
28		Output phase loss

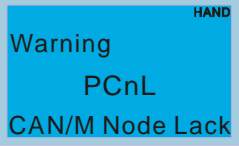
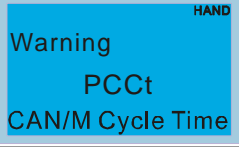
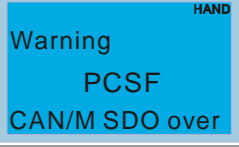
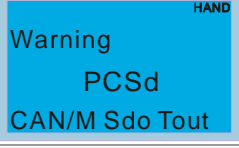
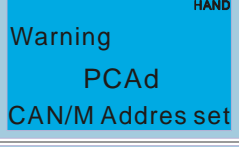
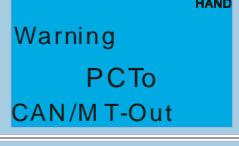
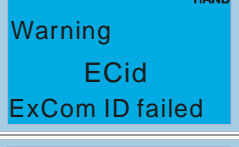
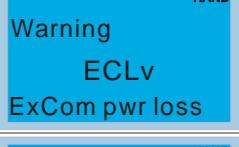
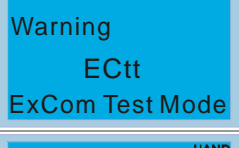
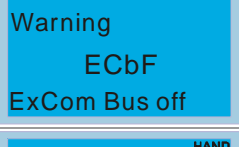
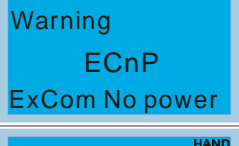
ID No.	Display on LCM Keypad	Descriptions
30	 <p>Warning SE3 Copy Model Err 3</p>	Keypad COPY error 3 Keypad copy between different power range drive
36	 <p>Warning CGdn Guarding T-out</p>	CAN guarding time-out 1
37	 <p>Warning CHbn Heartbeat T-out</p>	CAN heartbeat time-out 2
39	 <p>Warning CbFn Can Bus Off</p>	CAN bus off
40	 <p>Warning CIdn CAN/S Idx exceed</p>	CAN index error
41	 <p>Warning CAdn CAN/S Adres set</p>	CAN station address error
42	 <p>Warning CFrn CAN/S FRAM fail</p>	CAN memory error
43	 <p>Warning CSdn SDO T-out</p>	CAN SDO transmission time-out
44	 <p>Warning CSbn Buf Overflow</p>	CAN SDO received register overflow
46	 <p>Warning CPtn Error Protocol</p>	CAN format error
47	 <p>Warning PIra RTC Adjust</p>	Adjust RTC
50	 <p>Warning PLOd Opposite Defect</p>	PLC download error

ID No.	Display on LCM Keypad	Descriptions
51	 <p>Warning PLSv Save mem defect</p>	Save error of PLC download
52	 <p>Warning PLdA Data defect</p>	Data error during PLC operation
53	 <p>Warning PLFn Function defect</p>	Function code of PLC download error
54	 <p>Warning PLor Buf overflow</p>	PLC register overflow
55	 <p>Warning PLFF Function defect</p>	Function code of PLC operation error
56	 <p>Warning PLSn Check sum error</p>	PLC checksum error
57	 <p>Warning PLEd No end command</p>	PLC end command is missing
58	 <p>Warning PLCr PLC MCR error</p>	PLC MCR command error
59	 <p>Warning PLdF Download fail</p>	PLC download fail
60	 <p>Warning PLSF Scane time fail</p>	PLC scan time exceed
61	 <p>Warning PCGd CAN/M Guard err</p>	CAN Master guarding error
62	 <p>Warning PCbF CAN/M bus off</p>	CAN Master bus off

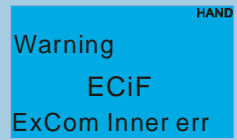
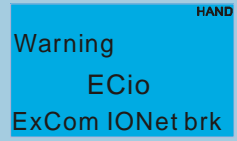
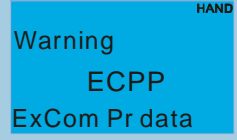
ID No.	Display on LCM Keypad	Descriptions
63	 <p>Warning PCnL CAN/M Node Lack</p>	CAN Master node error
64	 <p>Warning PCCt CAN/M Cycle Time</p>	CAN/M cycle time-out
65	 <p>Warning PCSF CAN/M SDO over</p>	CAN/M SDOover
66	 <p>Warning PCSd CAN/M Sdo Tout</p>	CAN/M SDO time-out
67	 <p>Warning PCAd CAN/M Address set</p>	CAN/M station address error
68	 <p>Warning PCTo CAN/M T-Out</p>	PLC/CAN Master Slave communication time out
70	 <p>Warning ECid ExCom ID failed</p>	Duplicate MAC ID error Node address setting error
71	 <p>Warning ECLv ExCom pwr loss</p>	Low voltage of communication card
72	 <p>Warning ECtt ExCom Test Mode</p>	Communication card in test mode
73	 <p>Warning ECbF ExCom Bus off</p>	DeviceNet bus-off
74	 <p>Warning ECnP ExCom No power</p>	DeviceNet no power
75	 <p>Warning ECFF ExCom Facky def</p>	Factory default setting error

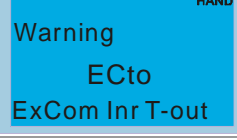
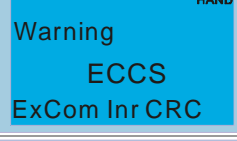
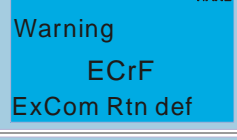
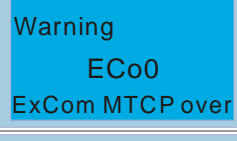
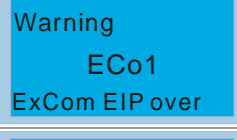
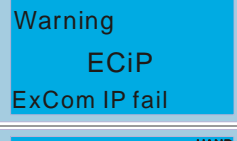
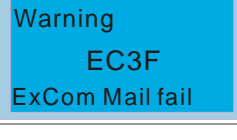
ID No.	Display on LCM Keypad	Descriptions
76	 <p>Warning ECiF ExCom Inner err</p>	Serious internal error
77	 <p>Warning ECio ExCom IONet brk</p>	IO connection break off
78	 <p>Warning ECPP ExCom Pr data</p>	Profibus parameter data error
79	 <p>Warning ECPI ExCom Conf data</p>	Profibus configuration data error
80	 <p>Warning ECEF ExCom Link fail</p>	Ethernet Link fail
81	 <p>Warning ECto ExCom Inr T-out</p>	Communication time-out for communication card and drive
82	 <p>Warning ECCS ExCom Inr CRC</p>	Check sum error for Communication card and drive
83	 <p>Warning ECrF ExCom Rtn def</p>	Communication card returns to default setting
84	 <p>Warning ECo0 ExCom MTCP over</p>	Modbus TCP exceed maximum communication value
85	 <p>Warning ECo1 ExCom EIP over</p>	EtherNet/IP exceed maximum communication value
86	 <p>Warning ECiP ExCom IP fail</p>	IP fail
87	 <p>Warning EC3F ExCom Mail fail</p>	Mail fail

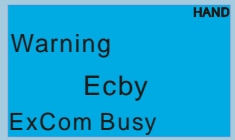
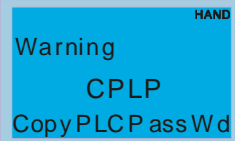
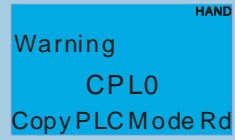
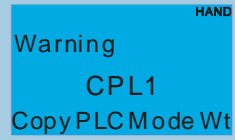
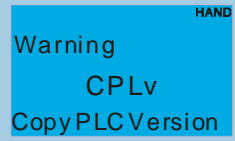
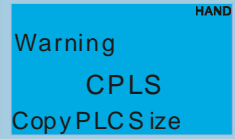
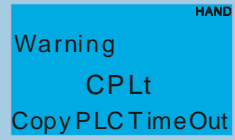
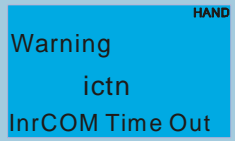
ID No.	Display on LCM Keypad	Descriptions
88	 <p>Warning Ecby ExCom Busy</p>	Communication card busy
90	 <p>Warning CPLP CopyPLCP assWd</p>	Copy PLC password error
91	 <p>Warning CPL0 CopyPLCMode Rd</p>	Copy PLC Read mode error
92	 <p>Warning CPL1 CopyPLCMode Wt</p>	Copy PLC Write mode error
93	 <p>Warning CPLv CopyPLCVersion</p>	Copy PLC Version error
94	 <p>Warning CPLS CopyPLCSize</p>	Copy PLC Capacity size error
96	 <p>Warning CPLt CopyPLCTimeOut</p>	Copy PLC time out
101	 <p>Warning ictn InrCOM Time Out</p>	Internal communication is off

[The page intentionally left blank]

Chapter 14 Fault Codes and Descriptions

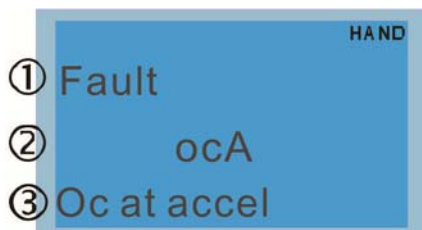

① Fault

②

ocA



③ Oc at accel

① Display error signal

② Abbreviate error code

③ Display error description

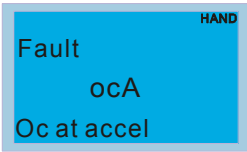
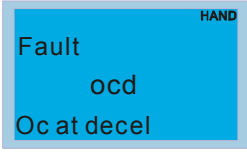
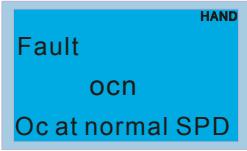

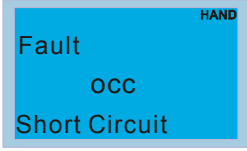
* Refer to setting of Pr06-17~Pr06~22.

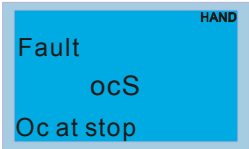
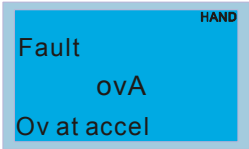
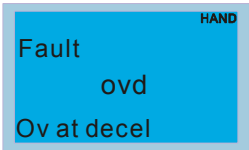
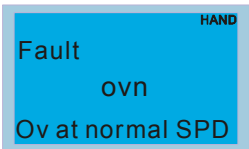
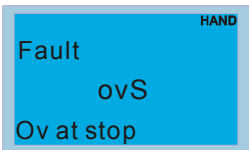
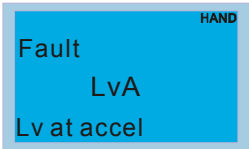
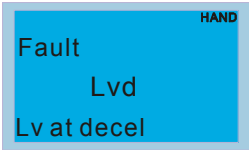
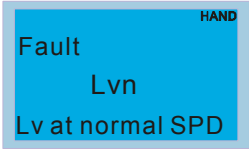
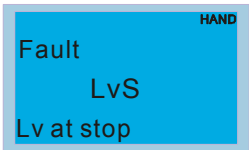
ID*	Fault Name	Fault Descriptions	Corrective Actions
1		Over-current during acceleration (Output current exceeds triple rated current during acceleration.)	<ol style="list-style-type: none"> Short-circuit at motor output: Check for possible poor insulation at the output. Acceleration Time too short: Increase the Acceleration Time. AC motor drive output power is too small: Replace the AC motor drive with the next higher power model.
2		Over-current during deceleration (Output current exceeds triple rated current during deceleration.)	<ol style="list-style-type: none"> Short-circuit at motor output: Check for possible poor insulation at the output. Deceleration Time too short: Increase the Deceleration Time. AC motor drive output power is too small: Replace the AC motor drive with the next higher power model.
3		Over-current during steady state operation (Output current exceeds triple rated current during constant speed.)	<ol style="list-style-type: none"> Short-circuit at motor output: Check for possible poor insulation at the output. Sudden increase in motor loading: Check for possible motor stall. AC motor drive output power is too small: Replace the AC motor drive with the next higher power model.
4		Ground fault	<p>When (one of) the output terminal(s) is grounded, short circuit current is more than 50% of AC motor drive rated current, the AC motor drive power module may be damaged.</p> <p>NOTE: The short circuit protection is provided for AC motor drive protection, not for protecting the user.</p> <ol style="list-style-type: none"> Check the wiring connections between the AC motor drive and motor for possible short circuits, also to ground. Check whether the IGBT power module is damaged. Check for possible poor insulation at the output.
5		Short-circuit is detected between upper bridge and lower bridge of the IGBT module	Return to the factory

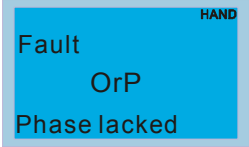
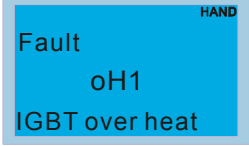
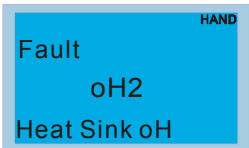
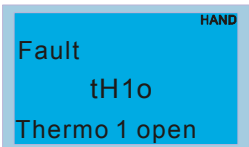
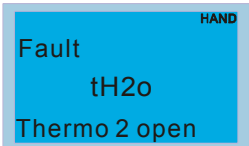
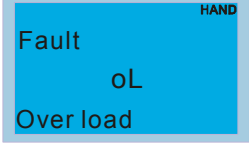
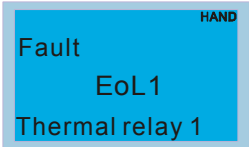
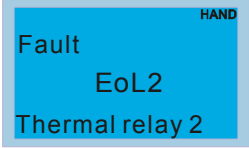
ID*	Fault Name	Fault Descriptions	Corrective Actions
6	 <p>Fault ocS Oc at stop</p>	Hardware failure in current detection	Return to the factory
7	 <p>Fault ovA Ov at accel</p>	DC BUS over-voltage during acceleration (460V: DC 900V)	<ol style="list-style-type: none"> 1. Check if the input voltage falls within the rated AC motor drive input voltage range. 2. Check for possible voltage transients. 3. If DC BUS over-voltage due to regenerative voltage, please increase the acceleration time or add an optional brake resistor.
8	 <p>Fault ovd Ov at decel</p>	DC BUS over-voltage during deceleration (460V: DC 900V)	<ol style="list-style-type: none"> 1. Check if the input voltage falls within the rated AC motor drive input voltage range. 2. Check for possible voltage transients. 3. If DC BUS over-voltage due to regenerative voltage, please increase the Deceleration Time or add an optional brake resistor.
9	 <p>Fault ovn Ov at normal SPD</p>	DC BUS over-voltage at constant speed (460V: DC 900V)	<ol style="list-style-type: none"> 1. Check if the input voltage falls within the rated AC motor drive input voltage range. 2. Check for possible voltage transients. 3. If DC BUS over-voltage due to regenerative voltage, please increase the Deceleration Time or add an optional brake resistor.
10	 <p>Fault ovS Ov at stop</p>	Hardware failure in voltage detection	<ol style="list-style-type: none"> 1. Check if the input voltage falls within the rated AC motor drive input voltage range. 2. Check for possible voltage transients.
11	 <p>Fault LvA Lv at accel</p>	DC BUS voltage is less than Pr.06-00 during acceleration	<ol style="list-style-type: none"> 1. Check if the input voltage is normal 2. Check for possible sudden load
12	 <p>Fault Lvd Lv at decel</p>	DC BUS voltage is less than Pr.06-00 during deceleration	<ol style="list-style-type: none"> 1. Check if the input voltage is normal 2. Check for possible sudden load
13	 <p>Fault Lvn Lv at normal SPD</p>	DC BUS voltage is less than Pr.06-00 in constant speed	<ol style="list-style-type: none"> 1. Check if the input voltage is normal 2. Check for possible sudden load
14	 <p>Fault LvS Lv at stop</p>	DC BUS voltage is less than Pr.06-00 at stop	<ol style="list-style-type: none"> 1. Check if the input voltage is normal 2. Check for possible sudden load

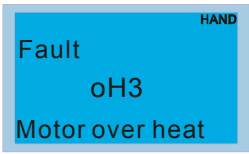
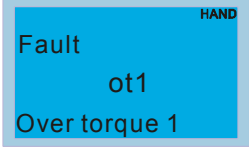
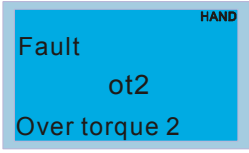
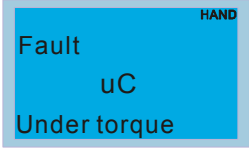
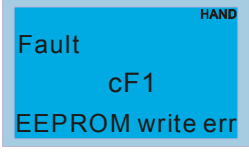
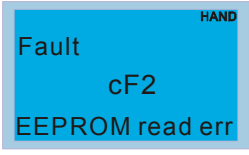
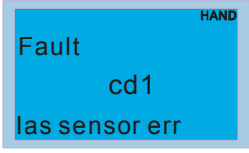
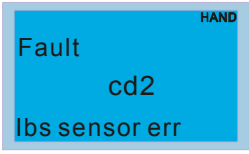
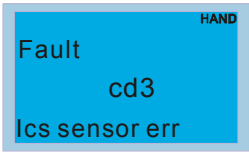
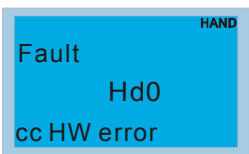
ID*	Fault Name	Fault Descriptions	Corrective Actions
15	 Fault OrP Phase lacked	Phase Loss	Check Power Source Input if all 3 input phases are connected without loose contacts. For models 40hp and above, please check if the fuse for the AC input circuit is blown.
16	 Fault oH1 IGBT over heat	IGBT overheating IGBT temperature exceeds protection level	<ol style="list-style-type: none"> 1. Ensure that the ambient temperature falls within the specified temperature range. 2. Make sure that the ventilation holes are not obstructed. 3. Remove any foreign objects from the heatsinks and check for possible dirty heat sink fins. 4. Check the fan and clean it. 5. Provide enough spacing for adequate ventilation.
17	 Fault oH2 Heat Sink oH	Heatsink overheating Capacitance temperature exceeds cause heatsink overheating.	<ol style="list-style-type: none"> 1. Ensure that the ambient temperature falls within the specified temperature range. 2. Make sure heat sink is not obstructed. Check if the fan is operating 3. Check if there is enough ventilation clearance for AC motor drive.
18	 Fault tH1o Thermo 1 open	IGBT Hardware Error	Return to the factory
19	 Fault tH2o Thermo 2 open	Capacitor Hardware Error	Return to the factory
21	 Fault oL Over load	Overload The AC motor drive detects excessive drive output current.	<ol style="list-style-type: none"> 1. Check if the motor is overloaded. 2. Take the next higher power AC motor drive model.
22	 Fault EoL1 Thermal relay 1	Electronics thermal relay 1 protection	<ol style="list-style-type: none"> 1. Check the setting of electronics thermal relay (Pr.06-14) Take the next higher power AC motor drive model
23	 Fault EoL2 Thermal relay 2	Electronics thermal relay 2 protection	<ol style="list-style-type: none"> 1. Check the setting of electronics thermal relay (Pr.06-28) 2. Take the next higher power AC motor drive model

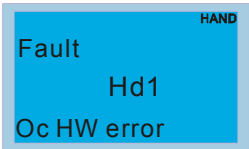
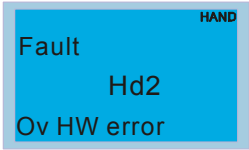
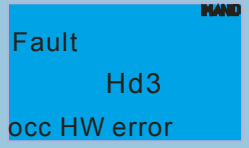
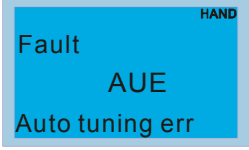
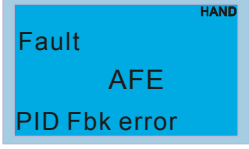
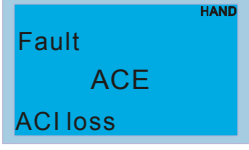
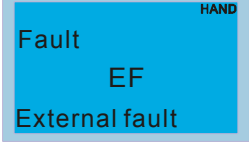
ID*	Fault Name	Fault Descriptions	Corrective Actions
24	 Fault oH3 Motor over heat	Motor overheating The AC motor drive detecting internal temperature exceeds the setting of Pr.06-30 (PTC level) or Pr.06-57 (PT100 level 2).	<ol style="list-style-type: none"> 1. Make sure that the motor is not obstructed. 2. Ensure that the ambient temperature falls within the specified temperature range. 3. Change to a higher power motor.
26	 Fault ot1 Over torque 1	These two fault codes will be displayed when output current exceeds the over-torque detection level (Pr.06-07 or Pr.06-10) and exceeds over-torque detection (Pr.06-08 or Pr.06-11) and it is set to 2 or 4 in Pr.06-06 or Pr.06-09.	<ol style="list-style-type: none"> 1. Check whether the motor is overloaded. 2. Check whether motor rated current setting (Pr.05-01) is suitable 3. Take the next higher power AC motor drive model.
27	 Fault ot2 Over torque 2		
28	 Fault uC Under torque	Low current detection	Check Pr.06-71, Pr.06-72, Pr.06-73.
30	 Fault cF1 EEPROM write err	Internal EEPROM can not be programmed.	<ol style="list-style-type: none"> 1. Press "RESET" key to the factory setting 2. Return to the factory.
31	 Fault cF2 EEPROM read err	Internal EEPROM can not be read.	<ol style="list-style-type: none"> 1. Press "RESET" key to the factory setting 2. Return to the factory.
33	 Fault cd1 las sensor err	U-phase error	Reboots the power. If fault code is still displayed on the keypad please return to the factory
34	 Fault cd2 lbs sensor err	V-phase error	Reboots the power. If fault code is still displayed on the keypad please return to the factory
35	 Fault cd3 lcs sensor err	W-phase error	Reboots the power. If fault code is still displayed on the keypad please return to the factory
36	 Fault Hd0 cc HW error	CC (current clamp)	Reboots the power. If fault code is still displayed on the keypad please return to the factory

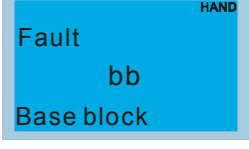
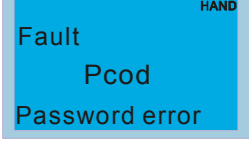
ID*	Fault Name	Fault Descriptions	Corrective Actions
37	 A blue rectangular display with a 'HAND' indicator in the top right corner. The text reads: 'Fault Hd1 Oc HW error'.	OC hardware error	Reboots the power. If fault code is still displayed on the keypad please return to the factory
38	 A blue rectangular display with a 'HAND' indicator in the top right corner. The text reads: 'Fault Hd2 Ov HW error'.	OV hardware error	Reboots the power. If fault code is still displayed on the keypad please return to the factory
39	 A blue rectangular display with a 'HAND' indicator in the top right corner. The text reads: 'Fault Hd3 occ HW error'.	Occ hardware error	Reboots the power. If fault code is still displayed on the keypad please return to the factory
40	 A blue rectangular display with a 'HAND' indicator in the top right corner. The text reads: 'Fault AUE Auto tuning err'.	Auto tuning error	<ol style="list-style-type: none"> 1. Check cabling between drive and motor 2. Try again.
41	 A blue rectangular display with a 'HAND' indicator in the top right corner. The text reads: 'Fault AFE PID Fbk error'.	PID loss (ACI)	<ol style="list-style-type: none"> 1. Check the wiring of the PID feedback 2. Check the PID parameters settings
48	 A blue rectangular display with a 'HAND' indicator in the top right corner. The text reads: 'Fault ACE ACI loss'.	ACI loss	<ol style="list-style-type: none"> 1. Check the ACI wiring 2. Check if the ACI signal is less than 4mA
49	 A blue rectangular display with a 'HAND' indicator in the top right corner. The text reads: 'Fault EF External fault'.	External Fault	<ol style="list-style-type: none"> 1. Input EF (N.O.) on external terminal is closed to GND. Output U, V, W will be turned off. 2. Give RESET command after fault has been cleared.
50	 A blue rectangular display with a 'HAND' indicator in the top right corner. The text reads: 'Fault EF1 Emergency stop'.	Emergency stop	<ol style="list-style-type: none"> 1. When the multi-function input terminals MI1 to MI6 are set to emergency stop, the AC motor drive stops output U, V, W and the motor coasts to stop. 2. Press RESET after fault has been cleared.
51	 A blue rectangular display with a 'HAND' indicator in the top right corner. The text reads: 'Fault bb Base block'.	External Base Block	<ol style="list-style-type: none"> 1. When the external input terminal (B.B) is active, the AC motor drive output will be turned off. 2. Deactivate the external input terminal (B.B) to operate the AC motor drive again.
52	 A blue rectangular display with a 'HAND' indicator in the top right corner. The text reads: 'Fault Pcod Password error'.	Password is locked.	Keypad will be locked. Turn the power ON after power OFF to re-enter the correct password. See Pr.00-07 and 00-08.

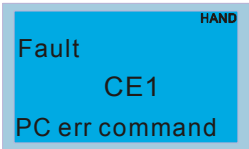
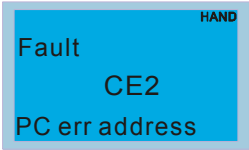
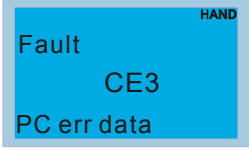
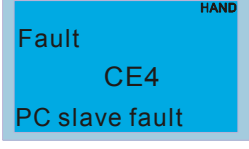
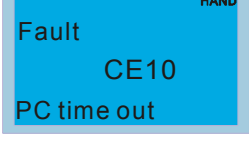
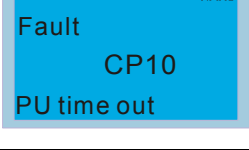
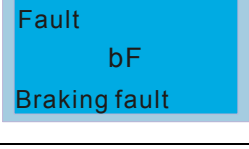
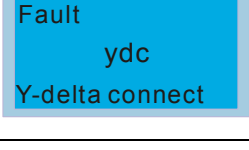
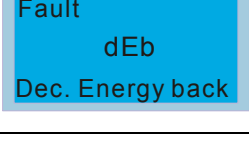
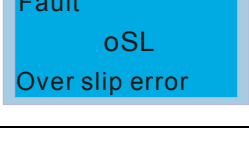
ID*	Fault Name	Fault Descriptions	Corrective Actions
54		Illegal function code	Check if the function code is correct (function code must be 03, 06, 10, 63)
55		Illegal data address (00H to 254H)	Check if the communication address is correct
56		Illegal data value	Check if the data value exceeds max./min. value
57		Data is written to read-only address	Check if the communication address is correct
58		Modbus transmission time-out	
59		Keypad transmission time-out	
60		Brake resistor fault	If the fault code is still displayed on the keypad after pressing "RESET" key, please return to the factory.
61		Y-connection/ Δ -connection switch error	<ol style="list-style-type: none"> 1. Check the wiring of the Y-connection/Δ-connection 2. Check the parameters settings
62		When Pr.07-13 is not set to 0 and momentary power off or power cut, it will display dEb during accel./decel. stop.	<ol style="list-style-type: none"> 1. Set Pr.07-13 to 0 2. Check if input power is stable
63		It will be displayed when slip exceeds Pr.05-26 setting and time exceeds Pr.05-27 setting.	<ol style="list-style-type: none"> 1. Check if motor parameter is correct (please decrease the load if overload) 2. Check the settings of Pr.05-26 and Pr.05-27

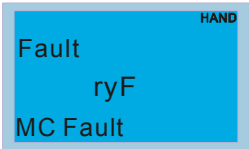
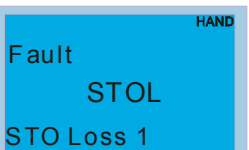
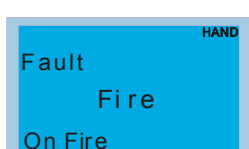
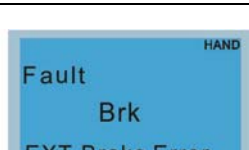
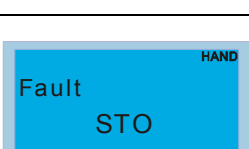
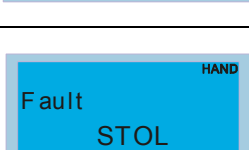
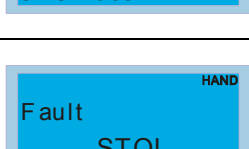
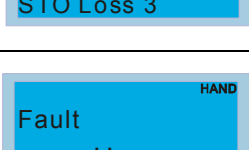
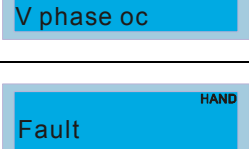
ID*	Fault Name	Fault Descriptions	Corrective Actions
64	 Fault ryF MC Fault	Electric valve switch error when executing Soft Start. (This warning is for frame E and higher frame of AC drives) Do not disconnect RST when drive is still operating.	
72	 Fault STOL STO Loss 1	STO1~SCM1 internal hardware detect error	
74	 Fault Fire On Fire	Fire mode	
75	 Fault Brk EXT-Brake Error	External brake fault	Verify M/I terminal signal
76	 Fault STO STO	Safety Torque Off function active	
77	 Fault STOL STO Loss 2	STO2~SCM2 internal hardware detect error	
78	 Fault STOL STO Loss 3	STO1~SCM1 and STO2~SCM2 internal hardware detect error	
79	 Fault Uoc U phase oc	Phase U short circuit	
80	 Fault Voc V phase oc	Phase V short circuit	
81	 Fault Woc W phase oc	W phase short circuit	

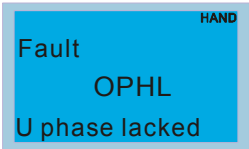
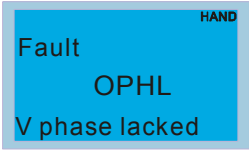
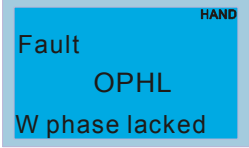
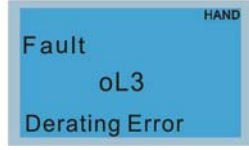
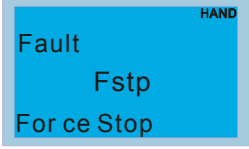
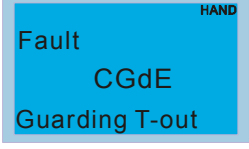
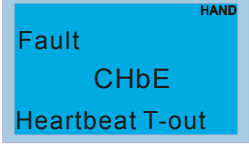
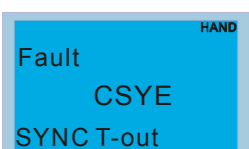
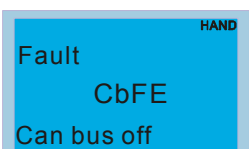
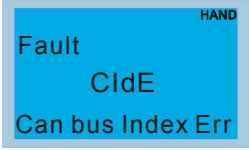
ID*	Fault Name	Fault Descriptions	Corrective Actions
82	 <p>Fault OPHL U phase lacked</p>	Output phase loss (Phase U)	
83	 <p>Fault OPHL V phase lacked</p>	Output phase loss (Phase V)	
84	 <p>Fault OPHL W phase lacked</p>	Output phase loss (Phase W)	
87	 <p>Fault oL3 Derating Error</p>	OL3 Fault Protection	
90	 <p>Fault Fstp Force Stop</p>	Internal PLC forced to stop Verify the setting of Pr.00-32	
101	 <p>Fault CGdE Guarding T-out</p>	CANopen guarding error	
102	 <p>Fault CHbE Heartbeat T-out</p>	CANopen heartbeat error	
103	 <p>Fault CSYE SYNC T-out</p>	CANopen synchronous error	
104	 <p>Fault CbFE Can bus off</p>	CANopen bus off error	
105	 <p>Fault CIdE Can bus Index Err</p>	CANopen index error	

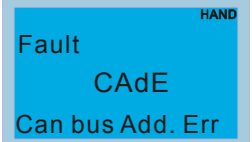
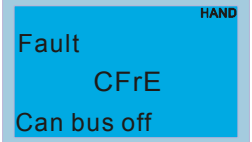
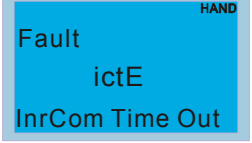
ID*	Fault Name	Fault Descriptions	Corrective Actions
106		CANopen station address error	
107		CANopen memory error	
111		Internal communication time-out	

[The page intentionally left blank]