

Automation for a Changing World

# Standard Compact Drive MS300 Series

[www.eletris.ru](http://www.eletris.ru)



 **DELTA**  
Smarter. Greener. Together.

# Compact and Intelligent

## The new standard for micro drives

The automation industry today continues to face challenges such as increasing competition and rising costs. In addition to improving productivity and reducing labor, the driving force for automation is the shift to higher efficiency, optimal quality, and most importantly, flexibility and compatibility for a wide range of applications.

Delta's MS300 series are the new generation high performance and standard compact vector control drives that inherit Delta's superior drive technology—all in a compact drive that has been reduced 40% in size.

A variety of essential functions are built-in as standard, including: PLC capacity for simple programming needs, a communication slots for various communication cards, and a USB port to make data uploads and downloads fast and easy. This saves the need for additional hardware, while providing more installation space for the power cabinet. Other key features include: Support for both IM and PM motor control for application flexibility, an STO function to ensure worry-free operation while protecting facilities from damage, and a simplified wiring process with a new screwless wiring design of terminal blocks for quick installation.

Saving space, reducing setup and wiring time, and providing high efficiency and a highly stable system, the MS300 are your key to improving market competitiveness and ensuring success.





## Models Overview

---

Standard Models  
High Speed Models  
Exterior Design and Interfaces  
Optional Cards

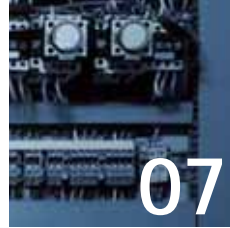

## Optimized Space Utilization

---

Compact Design  
Side-by-Side Installation



## Outstanding Drive Performance

---

Supports IM and PM Motors  
High Starting Torque  
Deceleration Energy Backup (DEB)  
Enhanced Braking Capability



## Strong System Support

---

Multi-motor Control  
Pulse Control  
Built-in PLC  
High Speed Applications  
24 V<sub>DC</sub> External Power  
High Overload Capability  
Built-in Brake Chopper  
Versatile Communications



## Stable, Safe and Reliable

---

Safety Standards  
Enhanced Conformal Coating  
IP40 Models  
Built-in EMC Filter



## Easy to Install

---

Application Groups  
Built-in USB Port  
Screwless Wiring of Control Terminal



## Wide Range of Applications

---

Machine Tools  
Woodworking Machines  
Automatic Tool Changers (ATC)  
Pumps  
Packaging Machines  
Textile Machines



## Specifications

---

Product Specifications  
Wiring  
Dimensions  
Accessories  
Model Name Explanation  
Ordering Information

# Models Overview



## Standard Models

### 115V single-phase

Applicable Motor Output (kW)	0.2	0.4	0.75
Applicable Motor Output (HP)	0.25	0.5	1
Frame Size	A		C

### 230V single-phase

Applicable Motor Output (kW)	0.2	0.4	0.75	1.5	2.2
Applicable Motor Output (HP)	0.25	0.5	1	2	3
Frame Size	A		B	C	

### 230V single-phase (Built-in EMC filter)

Applicable Motor Output (kW)	0.2	0.4	0.75	1.5	2.2
Applicable Motor Output (HP)	0.25	0.5	1	2	3
Frame Size	B			C	

### 230V 3-phase

Applicable Motor Output (kW)	0.2	0.4	0.75	1.5	2.2	3.7/4	5.5	7.5	11	15
Applicable Motor Output (HP)	0.25	0.5	1	2	3	5	7.5	10	15	20
Frame Size	A			B	C		D	E		F

### 460V 3-phase

Applicable Motor Output (kW)	0.4	0.75	1.5	2.2	3.7/4	5.5	7.5	11	15	18.5	22
Applicable Motor Output (HP)	0.5	1	2	3	5	7.5	10	15	20	25	30
Frame Size	A		B	C		D		E		F	

### 460V 3-phase (Built-in EMC filter)

Applicable Motor Output (kW)	0.4	0.75	1.5	2.2	3.7/4	5.5	7.5	11	15	18.5	22
Applicable Motor Output (HP)	0.5	1	2	3	5	7.5	10	15	20	25	30
Frame Size	B			C		D		E		F	

## High Speed Models



### 230V single-phase

Applicable Motor Output (kW)	1.5	2.2
Applicable Motor Output (HP)	2	3
Frame Size	C	

### 230V single-phase (Built-in EMC filter)

Applicable Motor Output (kW)	1.5	2.2
Applicable Motor Output (HP)	2	3
Frame Size	C	

### 230V 3-phase

Applicable Motor Output (kW)	1.5	2.2	3.7/4	5.5	7.5	11	15
Applicable Motor Output (HP)	2	3	5	7.5	10	15	20
Frame Size	B	C		D	E		F

### 460V 3-phase

Applicable Motor Output (kW)	1.5	2.2	3.7/4	5.5	7.5	11	15	18.5	22
Applicable Motor Output (HP)	2	3	5	7.5	10	15	20	25	30
Frame Size	B	C		D		E		F	

### 460V 3-phase (Built-in EMC filter)

Applicable Motor Output (kW)	1.5	2.2	3.7/4	5.5	7.5	11	15	18.5	22
Applicable Motor Output (HP)	2	3	5	7.5	10	15	20	25	30
Frame Size	B	C		D		E		F	

# Models Overview



## Hardware Design

Compact design and user-friendly interface

### Removable Keypad

Press to remove; for remote operation away from drive



### Built-in USB Port

Easy and fast programming setting, update and real-time monitoring and tuning



### Specified Product Label

Input/output current, voltage and protection rating

### Screwless Top Cover Design

Press on both side tabs to remove the cover



### Removable Fan

Easy to replace and maintain for a longer lifetime



5 digits 7 segments LED display, frequency knob, Up and Left/Down function keys

### Removable RFI Jumper

Applicable for different application needs



## Option Cards

A wide selection of option cards for highly flexible applications



### External Power Supply Card (DC 24V)



### Communication Cards

CANopen



DeviceNet



PROFIBUS DP



EtherNet/IP



MODBUS TCP



Built-in I/O slot \*1



# Optimized Space Utilization

## Compact Design

Provides more powerful features in smaller sizes with reduction up to 40% that effectively optimizes the installation space.



## Side-by-Side Installation

Supports side-by-side installation with operating temperatures of  $-20^{\circ}\text{C} \sim 40^{\circ}\text{C}$ . Enables highly flexible and highly efficient installation.

Substantial savings in space!





# Outstanding Drive Performance



## Supports IM and PM Motors

Supports 4 independent induction motor control parameter sets.

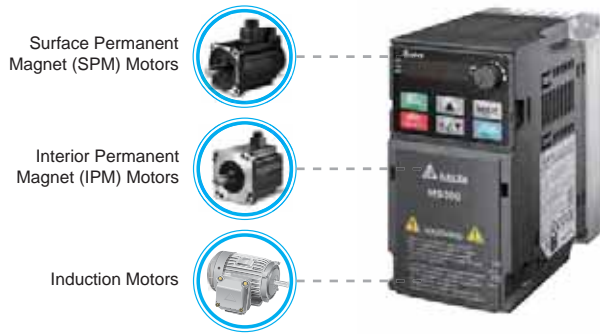

## High Starting Torque

Delivers 200% high starting torque with a low speed control of 0.5Hz. This feature provides outstanding machine stability and is suitable for dynamic loading applications.

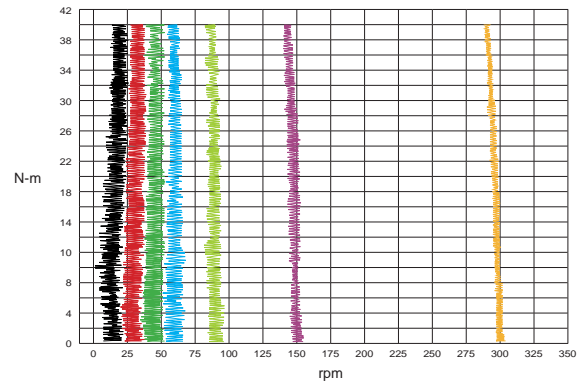

## Deceleration Energy Backup (DEB)

Controls the motor deceleration to a stop when an unexpected power shut-down occurs to prevent mechanical damage. When power resumes, the motor will accelerate to its previous speed.

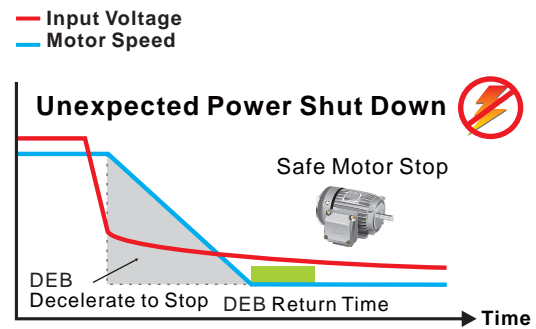
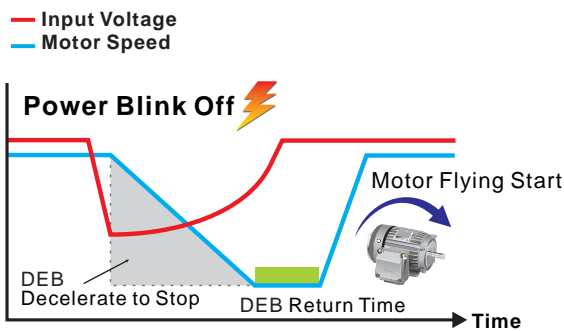

## Enhanced Braking Capability

Provides Deceleration Energy Control Mode to shorten braking time by adjusting the motor speed and current. This feature replaces the need for braking resistors.

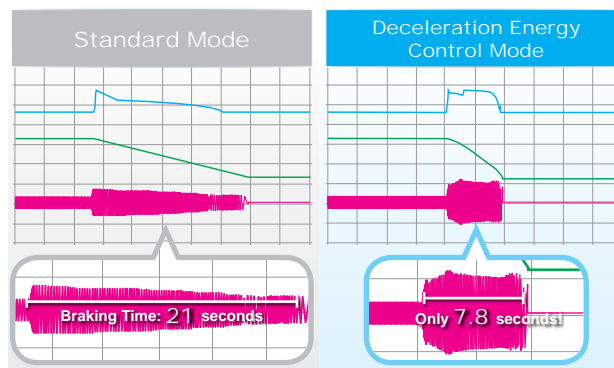

\* Actual deceleration performance varies upon different system loads

# Strong System Support

## Multi-motor Control

Supports 4 induction motors switching control.

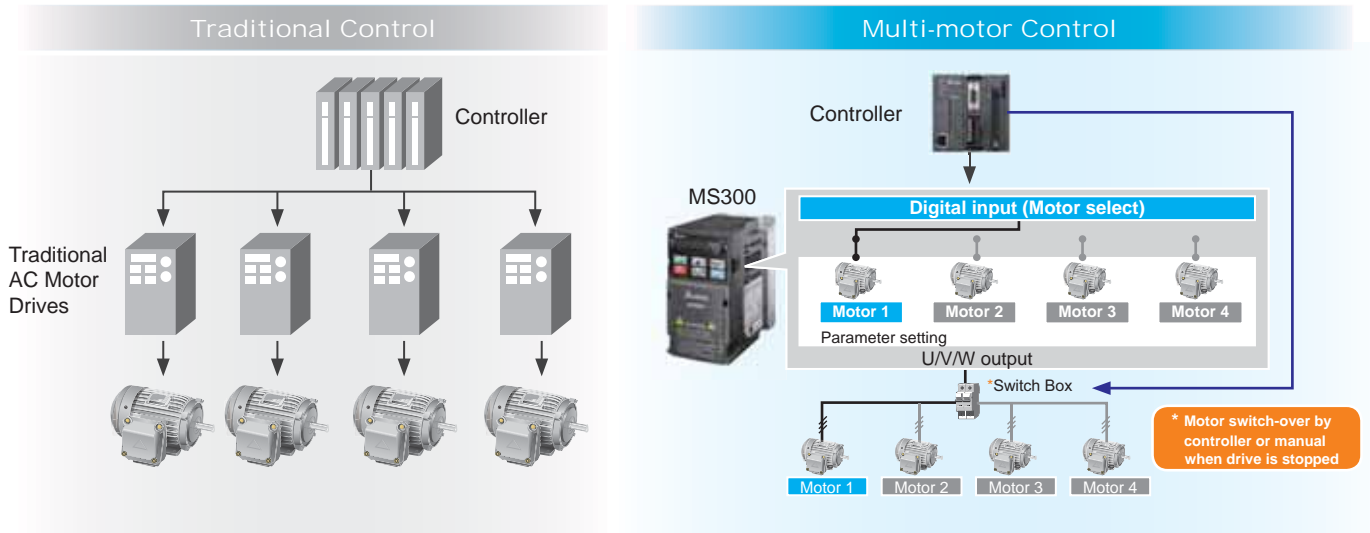

## Pulse Input

Supports single pulse input signal from controller as frequency command.

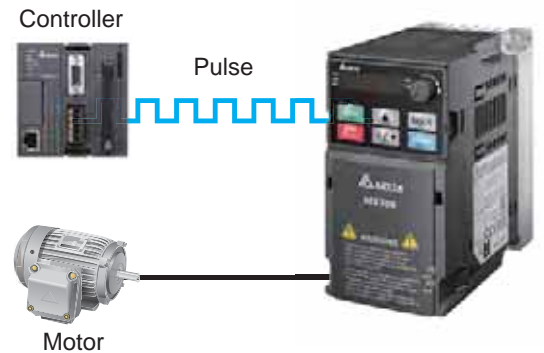

## Built-in PLC

Built-in PLC capacity (2k steps) to provide distributed control and independent operation via network connection.

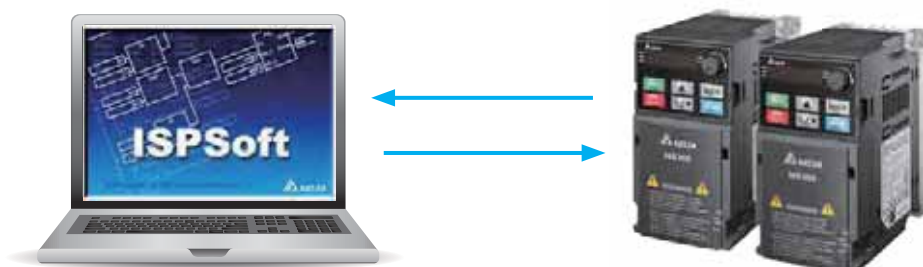

## High-Speed Applications

High-speed models are available to support high-speed processing.

Type	Model	Frequency Setting
Standard	VFD □□□MS□□□□SAA	0 ~ 599Hz
High-speed	VFD □□□MS□□□□SHA	0 ~ 1500Hz

## DC 24V External Power

External power supply card is available for external power connection. It protects the system and ensures uninterrupted communication when mains power failure occurs.

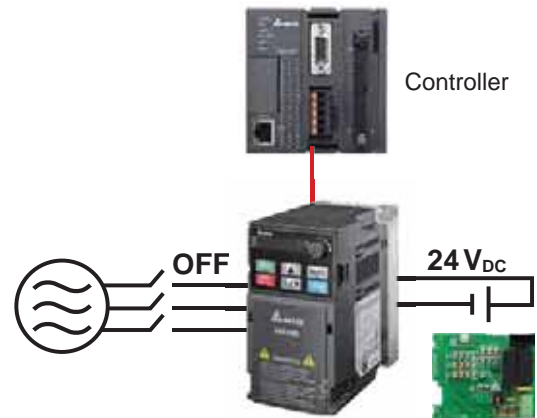

## High Overload Capability

- Normal duty: rated current 120% for 60 seconds; 150% for 3 seconds
- Heavy duty: rated current 150% for 60 seconds; 200% for 3 seconds

## Built-in Braking Chopper

Larger braking torque capability is provided by using an additional braking resistor.

## Versatile Communication Interfaces

Built-in RS-485 (MODBUS) and various communication card options.

Communication	MS300
MODBUS	Built-in
PROFIBUS DP	Optional
DeviceNet	Optional
MODBUS TCP	Optional
EtherNet/IP	Optional
CANopen	Optional
EtherCAT	(To be announced)

# Stable, Safe and Reliable



## Safety Standard

Integrated Safe Torque Off (STO), compliance with:

- ▶ ISO 13849-1:2015 Category 3 PL d
- ▶ EN 60204-1 Category 0
- ▶ EN 61508 SIL2
- ▶ EN 62061 SIL CL 2

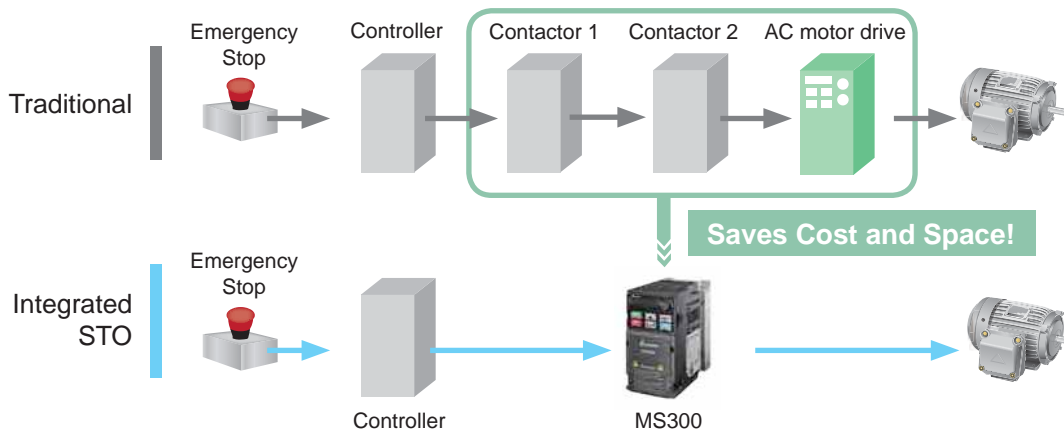

## PCB Coating

100% PCB coating (IEC 60721-3-3 class 3C2 standard) ensures drive operation stability and safety in critical environments.

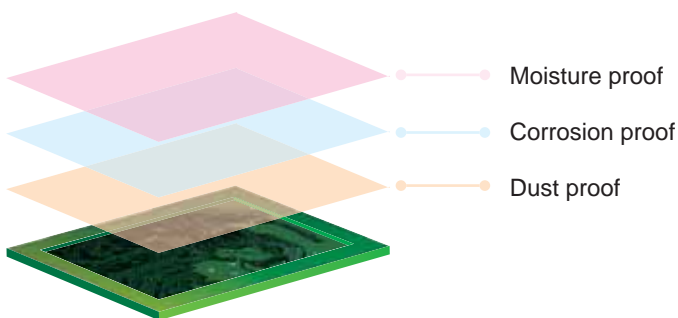

## IP40 Models

Strengthened fan coating and concealed air vent prevent dust and other particles from entering the drive, suitable for critical environment applications.



## Built-in EMC Filter

Built-in Class A (C2) standard EMC filter; saves on additional procurement cost and wiring time, and provides more cabinet space for other devices to use.

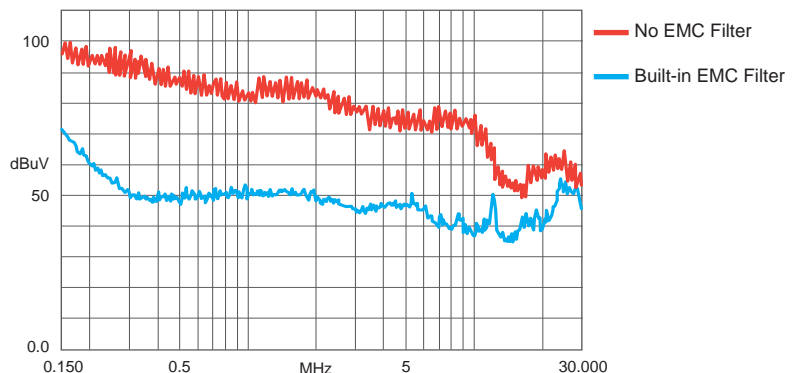

# Easy to Install

## Application Groups (Macro)

Simplifies the parameter setting process by grouping the parameters for different applications to use.

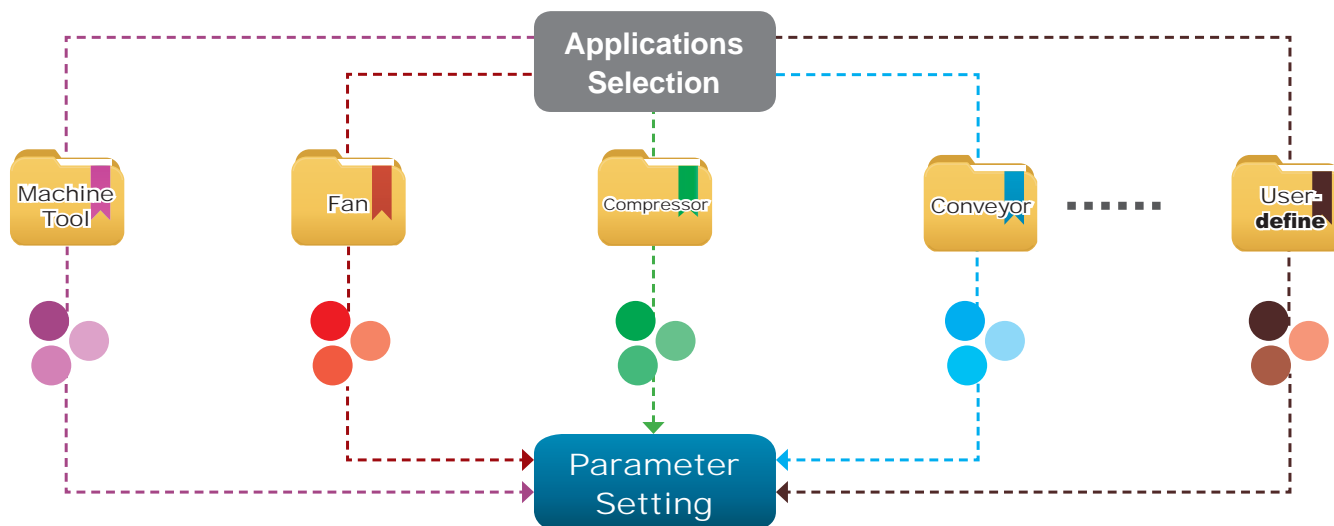

## Built-in USB Port

Built-in USB port facilitates the drive setting, updating, real-time monitoring and system tuning process.

- No need of USB or RS-485 connectors
- Supports offline (drive power off) parameter setting/copying and system update

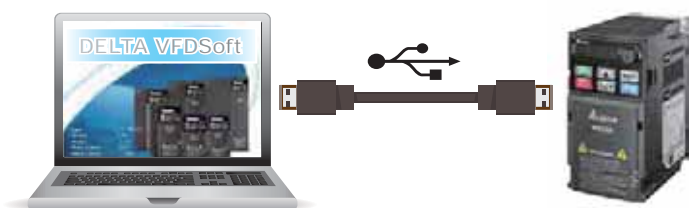

## Screwless Wiring of Control Terminal

Spring clamp terminal blocks provide fast and easy wiring

Saves wiring time

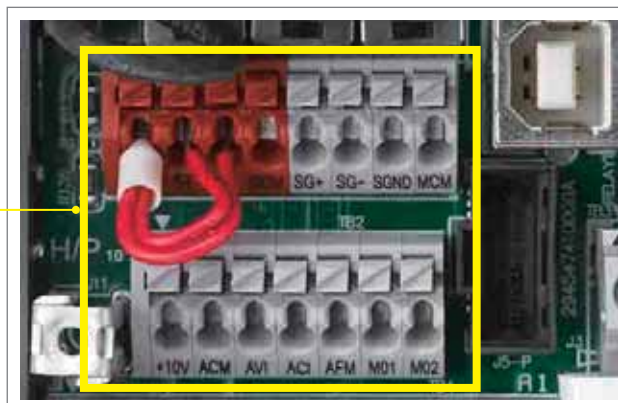

# Wide Range of Applications



## Machine Tools

### Features and Benefits

- High-speed models support main spindle 1500Hz frequency output; and is suitable for complex and high precision processing applications
- Timely acceleration/deceleration control to improve machinery operation efficiency
- Built-in braking chopper to save on purchasing cost
- Built-in PLC capacity for flexible application needs
- Built-in STO function ensures operator safety and effectively reduces accident risk
- Provides deceleration to stop function to protect tools from damage and ensure operator safety

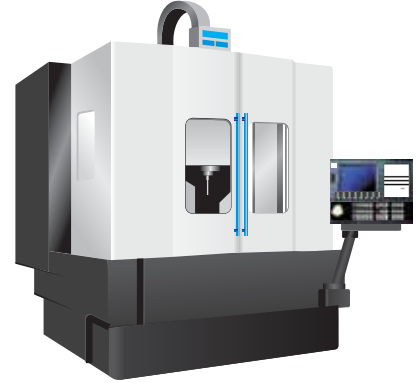

## Woodworking Machines

### Features and Benefits

- Timely acceleration/deceleration control, improves machinery operation efficiency
- Built-in STO function ensures operator safety and effectively reduces accident risk
- Built-in PLC capacity saves on purchasing cost
- Built-in EMC filter effectively reduces electromagnetic interference
- Compact in size and weight, easy to install and maintain

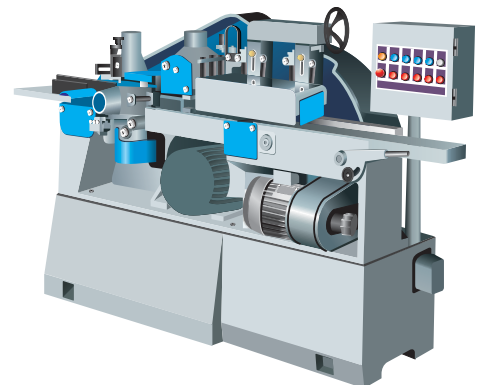

## Automatic Tool Changers (ATC)

### Features and Benefits

- Compact design of drive provides more cabinet space for other devices to use
- Quick start and timely acceleration/deceleration control function effectively shortens tool changing time and improves system efficiency and productivity
- Simple structure is easy to install and maintain
- Built-in STO function ensures operator safety and effectively reduces accident risk
- Built-in braking choppe saves on purchasing cost

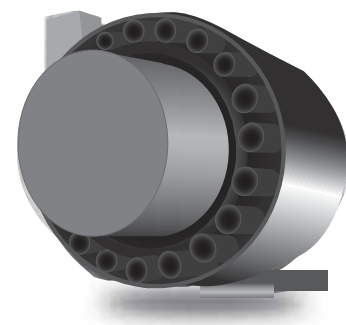

## Pump Applications

### Features and Benefits

- Built-in PID feedback control
- Built-in PLC capacity saves on purchasing cost of PLC and simpler wiring
- Supports a wide range of input voltages which are suitable for various types of pumps application and use in different countries
- Deceleration energy control mode shortens deceleration time and reduces braking resistor cost, also provides more space for other devices to use

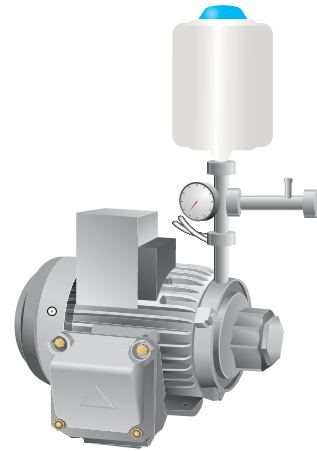

## Packaging Machines

### Features and Benefits

- Compact design of drive provides more cabinet space for other devices to use
- Built-in STO function ensures operator safety and effectively reduces accident rate
- Built-in braking chopper saves on system construction cost
- Built-in RS-485 (MODBUS) and various communication cards upon selection (optional)
- High-speed pulse input
- Supports frequency command by pulse input to improve control precision.



## Textile Machines

### Features and Benefits

- IP40 models provide excellent protection from a high dust, fiber or moisture environment
- Improved heatsink design prevents fiber clogging the air way; modular design of fan is easy to clean and provides longer lifetime
- Improved braking capability shortens the deceleration to stop time and is suitable for sudden stop requirements
- Built-in STO function ensures operator safety and effectively reduces accident rate
- Supports both induction motors and PM motors
- Provides deceleration to stop function to protect the equipment from damage when sudden power failure occurs



# Specifications

## Product Specifications

Single-phase  
115V

Frame			Models without built-in EMC filter		
Frame			A		C
Applicable Motor Output (kW)			0.2	0.4	0.75
Applicable Motor Output (HP)			1/4	1/2	1
Inverter Output	Heavy Duty	Rated Output Current (A)	1.6	2.5	4.8
	Normal Duty	Rated Output Current (A)	1.8	2.7	5.5
Carrier Frequency (kHz)			2 ~ 15kHz (default 4kHz)		
Brake Chopper			Built-in		
DC Reactor			Optional		
AC Reactor			Optional		
Cooling Method			Natural air cooling		Fan cooling
Size: W×H (mm)			68×128		87×157
Size: D (mm)			96	125	152

Single-phase  
230V

Frame			Models with built-in EMC filter				
Frame			B		C		
Applicable Motor Output (kW)			0.2	0.4	0.75	1.5	2.2
Applicable Motor Output (HP)			1/4	1/2	1	2	3
Inverter Output	Heavy Duty	Rated Output Current (A)	1.6	2.8	4.8	7.5	11
	Normal Duty	Rated Output Current (A)	1.8	3.2	5	8.5	12.5
Carrier Frequency (kHz)			2 ~ 15kHz (default 4kHz)				
Brake Chopper			Built-in				
DC Reactor			Optional				
AC Reactor			Optional				
Cooling Method			Natural air cooling	Fan cooling			
Size: W×H (mm)			72×142			87×157	
Size: D (mm)			159			179	
Frame			Models without an EMC filter				
Frame			A	B	C		
Cooling Method			Natural air cooling			Fan cooling	
Size: W×H (mm)			68×128	68×128	72×142	87×157	
Size: D (mm)			96	125	143	152	



3-phase  
230 V

Models without built-in EMC filter

Frame			A			B	C		D	E		F
Applicable Motor Output (kW)			0.2	0.4	0.75	1.5	2.2	3.7/4	5.5	7.5	11	15
Applicable Motor Output (HP)			1/4	1/2	1	2	3	5	7.5	10	15	20
Inverter Output	Heavy Duty	Rated Output Current (A)	1.6	2.8	4.8	7.5	11	17	25	33	49	65
	Normal Duty	Rated Output Current (A)	1.8	3.2	5	8	12.5	19.5	27	36	51	69
Carrier Frequency (kHz)			2 ~ 15kHz (default 4kHz)									
Brake Chopper			Built-in									
DC Reactor			Optional									
AC Reactor			Optional									
Cooling Method			Natural air cooling			Fan cooling						
Size: W×H (mm)			68×128			72×142	87×157	109×207	130×250	175×300		
Size: D (mm)			96	110	143	143	152	154	185	192		

3-phase  
460 V

Models with built-in EMC filter

Frame			B			C		D		E		F	
Applicable Motor Output (kW)			0.4	0.75	1.5	2.2	3.7/4	5.5	7.5	11	15	18.5	22
Applicable Motor Output (HP)			1/2	1	2	3	5	7.5	10	15	20	25	30
Inverter Output	Heavy Duty	Rated Output Current (A)	1.5	2.7	4.2	5.5	9	13	17	25	32	38	45
	Normal Duty	Rated Output Current (A)	1.8	3	4.6	6.5	10.5	15.7	20.5	28	36	41.5	49
Carrier Frequency (kHz)			2 ~ 15kHz (default 4kHz)										
Brake Chopper			Built-in										
DC Reactor			Optional										
AC Reactor			Optional										
Cooling Method			Fan cooling										
Size: W×H (mm)			72×142			87×157	109×207	130×250	175×300				
Size: D (mm)			159			179	187	219	244				
Models without an EMC filter													
Frame			A		B	C		D	E		F		
Cooling Method			Natural air cooling		Fan cooling								
Size: W×H (mm)			68×128		72×142	87×157	109×207	130×250	175×300				
Size: D (mm)			129	143	143	152	154	185	192				

# General Specifications and Accessories

Control Functions	Control Methods	V/F, SVC
	Applicant Motors	Induction Motor (IM), Interior Permanent Magnet (IPM) Motor, Surface Permanent Magnet (SPM) Motor
	Max. Output Frequency	Standard model: 599.00Hz ; High speed model: 1500.0Hz (with derating, V/F control only)
	Starting Torque*	150%/3 Hz ( V/f, SVC control for IM, Heavy duty ) 100%/(1/20 of motor rated frequency) ( SVC control for PM, Heavy duty )
	Speed Control Range*	1 : 50 ( V/f, SVC control for IM, Heavy duty ) 1 : 20 ( SVC control for PM, Heavy duty )
	Overload Tolerance	Normal Duty (ND): 120% of rated output current for 60 seconds; 150% of rated output current for 3 seconds Heavy Duty (HD): 150% of rated output current for 60 seconds; 200% of rated output current for 3 seconds
	Frequency Setting Signal	0 ~ +10V/-10V ~ +10V, 4 ~ 20mA/0 ~ +10V, 1 Pulse input (33kHz), 1 Pulse output (33kHz)
	Main Control Functions	Multiple motor switches (max. 4 independent motor parameter settings), Fast run, Deceleration Energy Back (DEB) function, Wobble frequency function, Fast deceleration function, Master and Auxiliary frequency source selectable, Momentary power loss ride thru, Speed search, Over-torque detection, 16-step speed (max.), Accel/decel time switch, S-curve accel/decel, 3-wire sequence, JOG frequency, Upper/lower limits for frequency reference, DC injection braking at start and stop, PID control, Built-in PLC (2k steps), Simple positioning function, MODBUS is integrated as standard
Protection Functions	Motor Protection	Overcurrent protection, overvoltage protection, over-temperature protection, Phase failure protection
	Stall Prevention	Stall prevention during acceleration, deceleration and running independently
Accessories	Communication cards	PROFIBUS DP, DeviceNet, MODBUS TCP, EtherNet/IP, CANopen
	External DC power supply	EMM-BPS01 (DC 24V power supply card )
Digital Controller		A removable keypad as standard
Certifications		UL, CE, RoHS, RCM, TUV, REACH

\*Control accuracy may vary depending on the environment, application conditions, different motors or encoder. For details, please contact our company or your local distributor.

## MS300 Operating Environment

Operating Environment	Installation Location		IEC60364-1/IEC60664-1 Pollution degree 2, Indoor use only	
	Ambient Temperature	Operation	IP20/UL Open Type	-20 to 50 °C -20 to 60 °C (needs derating)
			IP40/NEMA 1/UL Type 1	-20 to 40 °C
			Zero stacking Installation	-20 to 50 °C (needs derating)
		Storage	-40 to 85 °C	
		Transportation	-20 to 70 °C	
	Rated Humidity	Operation	Max. 90%	
		Storage/Transportation	Max. 95%	
	Air Pressure	Operation	86 ~ 106 kPa	
		Storage/Transportation	70 ~ 106 kPa	
	Pollution Level	Compliance to IEC60721-3-3, 3C2		
Altitude	An altitude of 0 ~ 1000m for normal operation (derating is required for installation at an altitude above 1000 m)			
Vibration		Compliance to IEC 60068-2-6		
Shock		Compliance to IEC/EN 60068-2-27		

Please refer to MS300 user manual for more details.

# Wiring

## Input: Single-phase/3-phase power

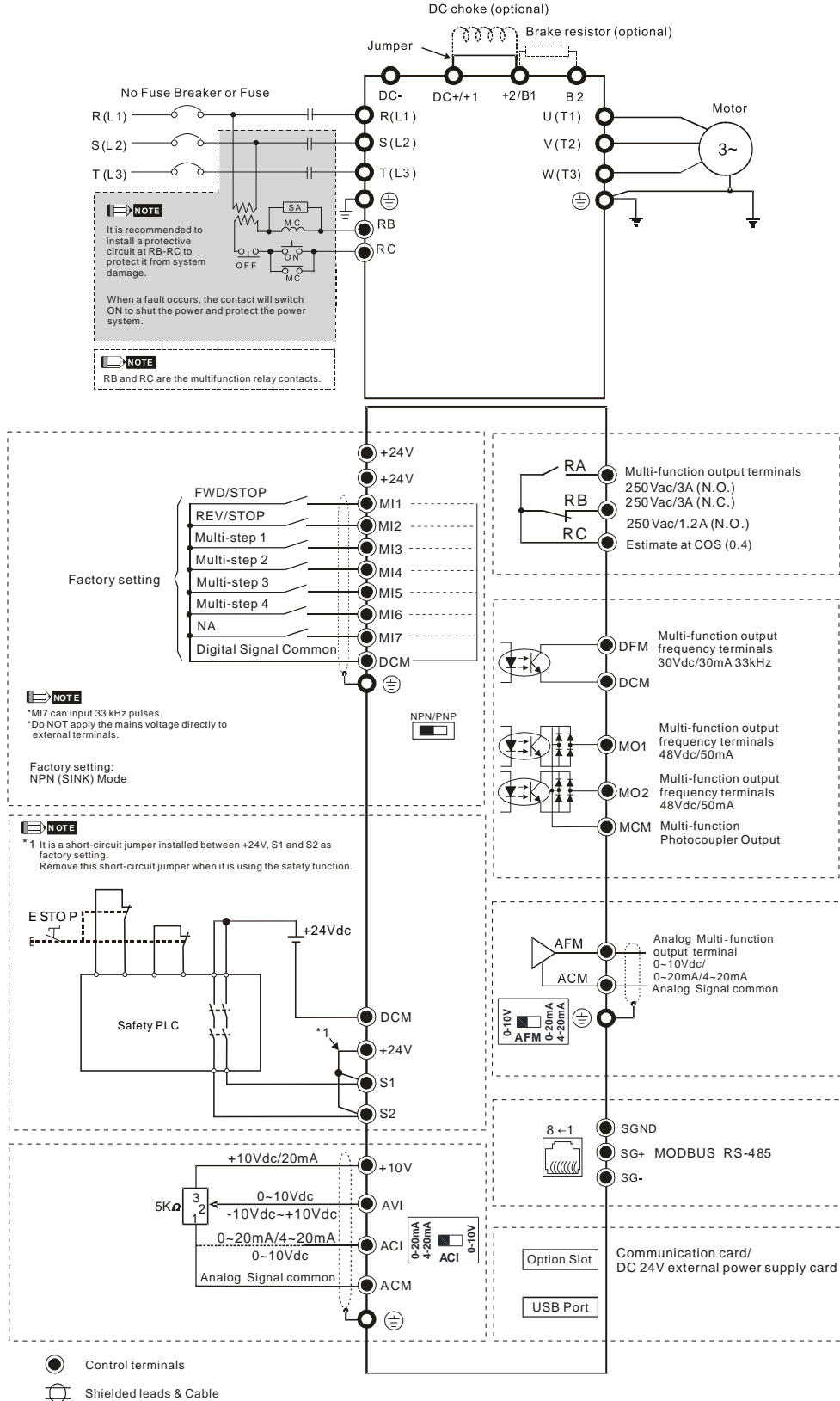

# Dimensions

## Frame A

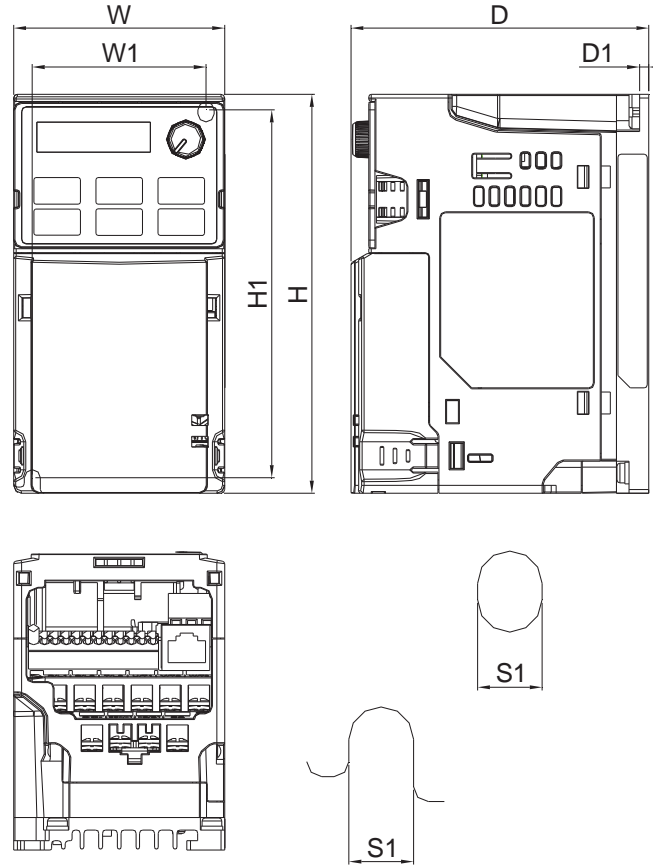

Mounting hole

MODEL	FRAME A1	FRAME A2	FRAME A3	FRAME A4	FRAME A5
VFD1A6MS11ANSAA	VFD2A8MS23ANSAA	VFD2A5MS11ANSAA	VFD1A5MS43ANSAA	VFD4A8MS23ANSAA	
VFD1A6MS11ENSAA	VFD2A8MS23ENSAA	VFD2A5MS11ENSAA	VFD1A5MS43ENSAA	VFD4A8MS23ENSAA	
VFD1A6MS21ANSAA		VFD2A8MS21ANSAA		VFD2A7MS43ANSAA	
VFD1A6MS21ENSAA		VFD2A8MS21ENSAA		VFD2A7MS43ENSAA	
VFD1A6MS23ANSAA					
VFD1A6MS23ENSAA					

Frame	W	H	D	W1	H1	D1	S1	
A1	mm	68.0	128.0	96.0	56.0	118.0	3.0	5.2
	inch	2.68	5.04	3.78	2.20	4.65	0.12	0.20
A2	mm	68.0	128.0	110.0	56.0	118.0	3.0	5.2
	inch	2.68	5.04	4.33	2.20	4.65	0.12	0.20
A3	mm	68.0	128.0	125.0	56.0	118.0	3.0	5.2
	inch	2.68	5.04	4.92	2.20	4.65	0.12	0.20

Frame	W	H	D	W1	H1	D1	S1	
A4	mm	68.0	128.0	129.0	56.0	118.0	3.0	5.2
	inch	2.68	5.04	5.08	2.20	4.65	0.12	0.20
A5	mm	68.0	128.0	143.0	56.0	118.0	3.0	5.2
	inch	2.68	5.04	5.63	2.20	4.65	0.12	0.20

## Frame B

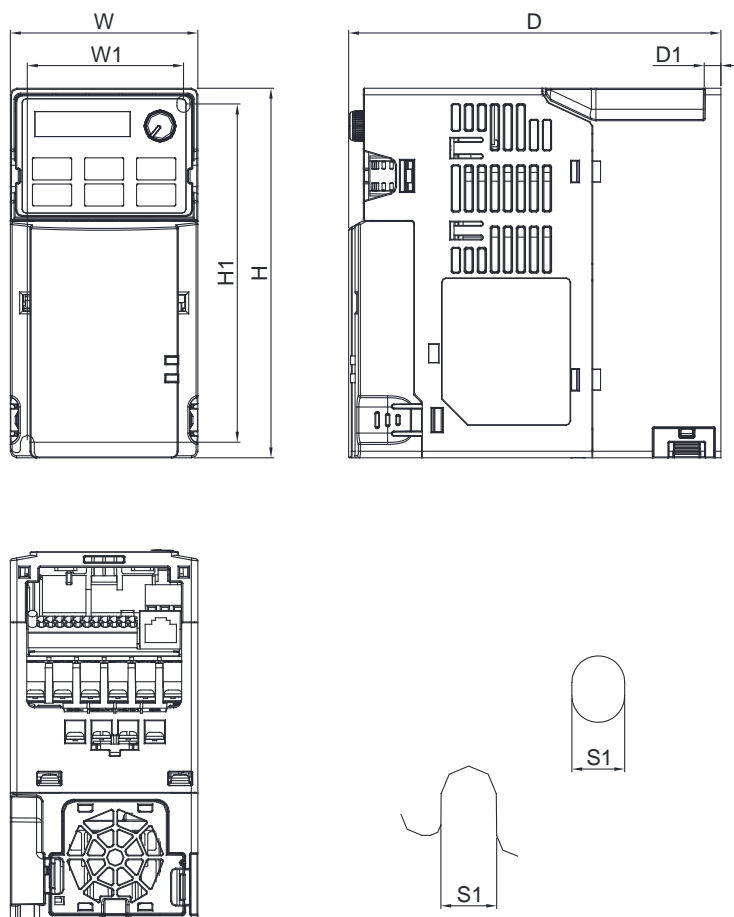

Mounting hole

### MODEL FRAME B1

Standard Models:  
VFD7A5MS23ANSAA  
VFD7A5MS23ENSAA  
VFD4A2MS43ANSAA  
VFD4A2MS43ENSAA

High Speed Models:  
VFD7A5MS23ANSHA  
VFD7A5MS23ENSHA  
VFD4A2MS43ANSHA  
VFD4A2MS43ENSHA

### FRAME B2

Standard Models:  
VFD4A8MS21ANSAA  
VFD4A8MS21ENSAA

### FRAME B3

Standard Models:  
VFD1A6MS21AFSAA  
VFD2A8MS21AFSAA  
VFD4A8MS21AFSAA  
VFD1A5MS43AFSAA  
VFD2A7MS43AFSAA  
VFD4A2MS43AFSAA

High Speed Models:  
VFD4A2MS43AFSHA

Frame		W	H	D	W1	H1	D1	S1
B1	mm	72.0	142.0	143.0	60.0	130.0	6.4	5.2
	inch	2.83	5.59	5.63	2.36	5.12	0.25	0.20
Frame		W	H	D	W1	H1	D1	S1
B2	mm	72.0	142.0	143.0	60.0	130.0	3.0	5.2
	inch	2.83	5.59	5.63	2.36	5.12	0.12	0.20
Frame		W	H	D	W1	H1	D1	S1
B3	mm	72.0	142.0	159.0	60.0	130.0	4.3	5.2
	inch	2.83	5.59	6.26	2.36	5.12	0.17	0.20

# Dimensions

## Frame C

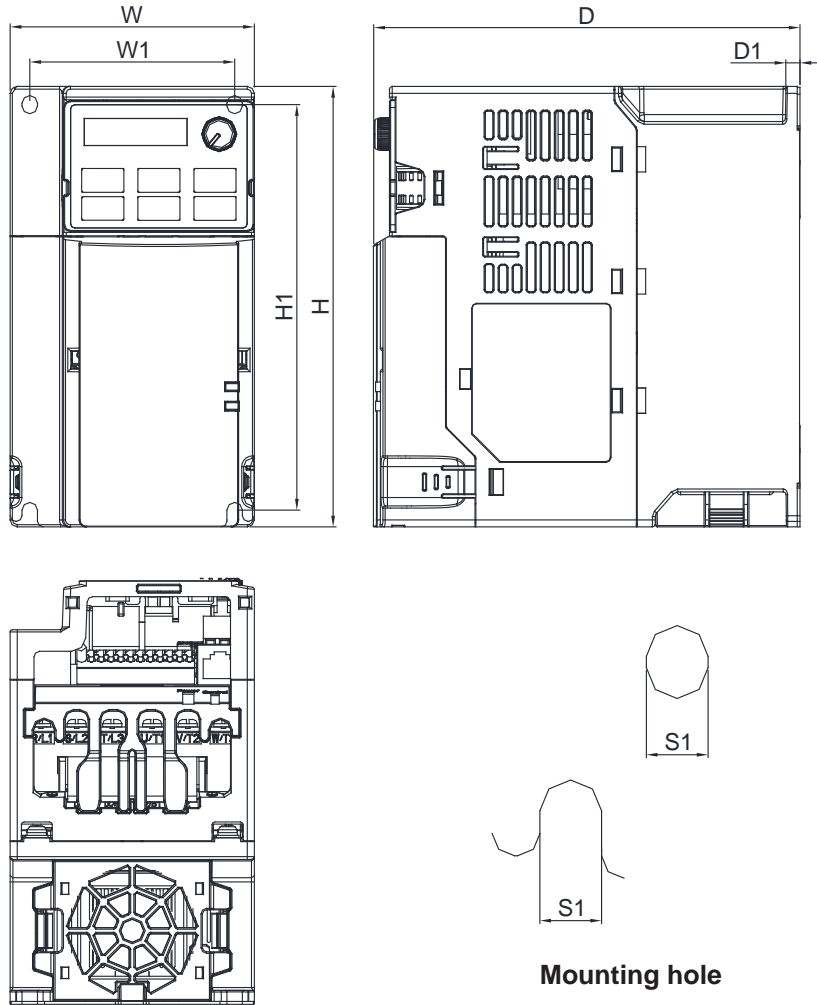

### MODEL FRAME C1

#### Standard Models:

VFD4A8MS11ANSAA VFD4A8MS11ENSAA  
 VFD7A5MS21ANSAA VFD7A5MS21ENSAA  
 VFD11AMS21ANSAA VFD11AMS21ENSAA  
 VFD11AMS23ANSAA VFD11AMS23ENSAA  
 VFD17AMS23ANSAA VFD17AMS23ENSAA  
 VFD5A5MS43ANSAA VFD5A5MS43ENSAA  
 VFD9A0MS43ANSAA VFD9A0MS43ENSAA

#### High Speed Models:

VFD7A5MS21ANSHA VFD7A5MS21ENSHA  
 VFD11AMS21ANSHA VFD11AMS21ENSHA  
 VFD11AMS23ANSHA VFD11AMS23ENSHA  
 VFD17AMS23ANSHA VFD17AMS23ENSHA  
 VFD5A5MS43ANSHA VFD5A5MS43ENSHA  
 VFD9A0MS43ANSHA VFD9A0MS43ENSHA

### FRAME C2

#### Standard Models:

VFD7A5MS21AFSAA VFD7A5MS21AFSHA  
 VFD11AMS21AFSAA VFD11AMS21AFSHA  
 VFD5A5MS43AFSAA VFD5A5MS43AFSHA  
 VFD9A0MS43AFSAA VFD9A0MS43AFSHA

#### High Speed Models:

VFD7A5MS21AFSHA VFD7A5MS21AFSHA  
 VFD11AMS21AFSHA VFD11AMS21AFSHA  
 VFD5A5MS43AFSHA VFD5A5MS43AFSHA  
 VFD9A0MS43AFSHA VFD9A0MS43AFSHA

Frame		W	H	D	W1	H1	D1	S1
C1	mm	87.0	157.0	152.0	73.0	144.5	5.0	5.5
	inch	3.43	6.18	5.98	2.87	5.69	0.20	0.22
Frame		W	H	D	W1	H1	D1	S1
C2	mm	87.0	157.0	179.0	73.0	144.5	5.0	5.5
	inch	3.43	6.18	7.05	2.87	5.69	0.20	0.22

## Frame D

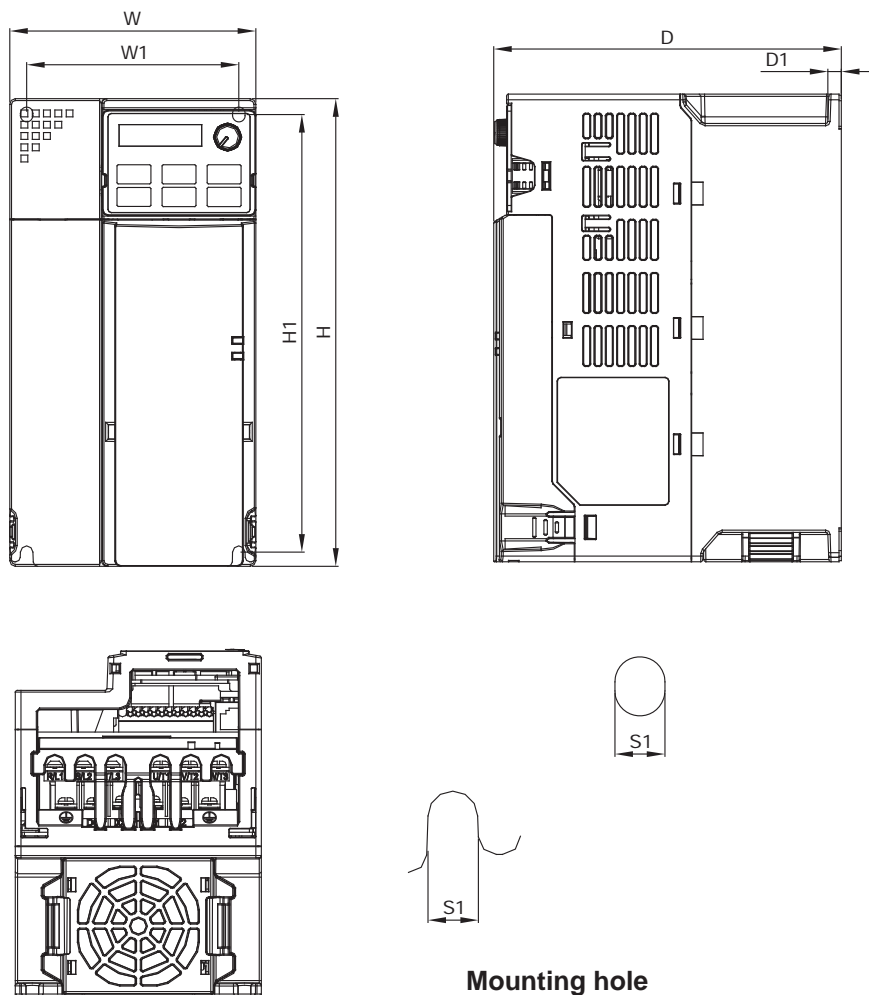

Mounting hole

### MODEL FRAME D1

Standard Models:  
 VFD25AMS23ANSAA  
 VFD25AMS23ENSAA  
 VFD13AMS43ANSAA  
 VFD13AMS43ENSAA  
 VFD17AMS43ANSAA  
 VFD17AMS43ENSAA

High Speed Models:  
 VFD25AMS23ANSHA  
 VFD25AMS23ENSHA  
 VFD13AMS43ANSHA  
 VFD13AMS43ENSHA  
 VFD17AMS43ANSHA  
 VFD17AMS43ENSHA

### FRAME D2

Standard Models:  
 VFD13AMS43AFSAA  
 VFD17AMS43AFSAA

High Speed Models:  
 VFD13AMS43AFSHA  
 VFD17AMS43AFSHA

Frame		W	H	D	W1	H1	D1	S1
D1	mm	109.0	207.0	154.0	94.0	193.8	6.0	5.5
	inch	4.29	8.15	6.06	3.70	7.63	0.24	0.22
Frame		W	H	D	W1	H1	D1	S1
D2	mm	109.0	207.0	187.0	94.0	193.8	6.0	5.5
	inch	4.29	8.15	7.36	3.70	7.63	0.24	0.22

# Dimensions

## Frame E

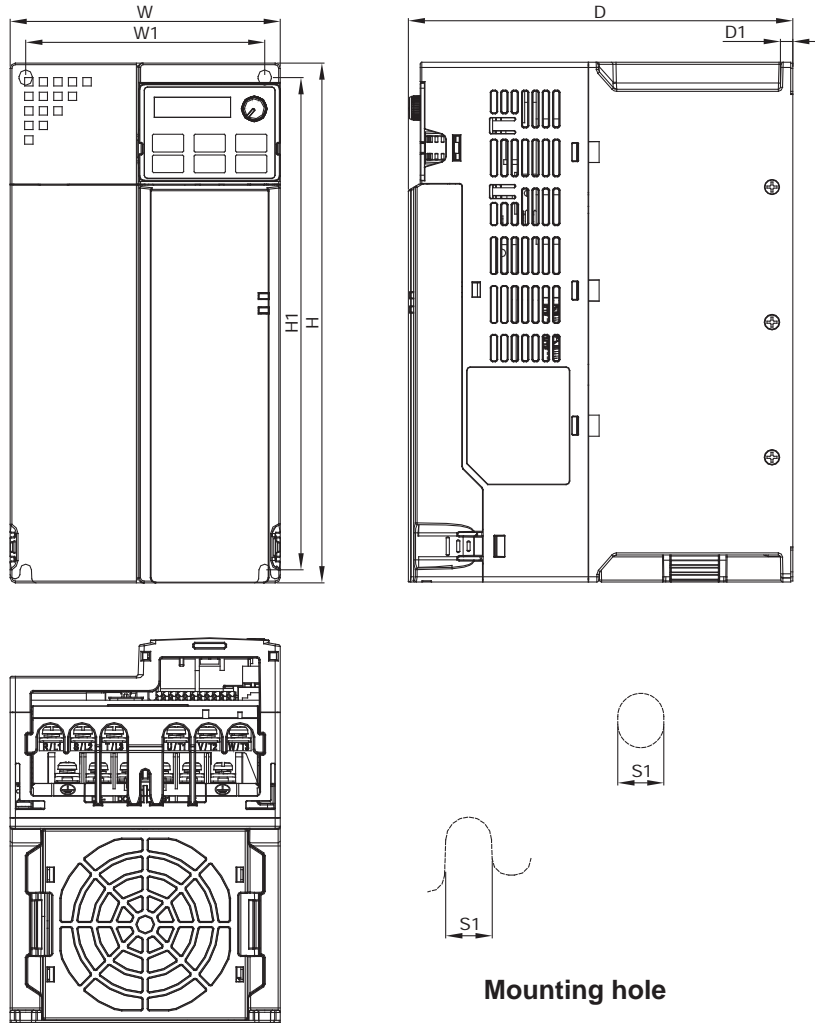

### MODEL FRAME E1

Standard Models:  
 VFD33AMS23ANSAA  
 VFD33AMS23ENSAA  
 VFD49AMS23ANSAA  
 VFD49AMS23ENSAA  
 VFD25AMS43ANSAA  
 VFD25AMS43ENSAA  
 VFD32AMS43ANSAA  
 VFD32AMS43ENSAA

High Speed Models:  
 VFD33AMS23ANSHA  
 VFD33AMS23ENSHA  
 VFD49AMS23ANSHA  
 VFD49AMS23ENSHA  
 VFD25AMS43ANSHA  
 VFD25AMS43ENSHA  
 VFD32AMS43ANSHA  
 VFD32AMS43ENSHA

### FRAME E2

Standard Models:  
 VFD25AMS43AFSAA  
 VFD32AMS43AFSAA

High Speed Models:  
 VFD25AMS43AFSHA  
 VFD32AMS43AFSHA

Frame		W	H	D	W1	H1	D1	S1
E1	mm	130.0	250.0	185.0	115.0	236.8	6.0	5.5
	inch	5.12	9.84	7.83	4.53	9.32	0.24	0.22
Frame		W	H	D	W1	H1	D1	S1
E2	mm	130.0	250.0	219.0	115.0	236.8	6.0	5.5
	inch	5.12	9.84	8.62	4.53	9.32	0.24	0.22



## Frame F

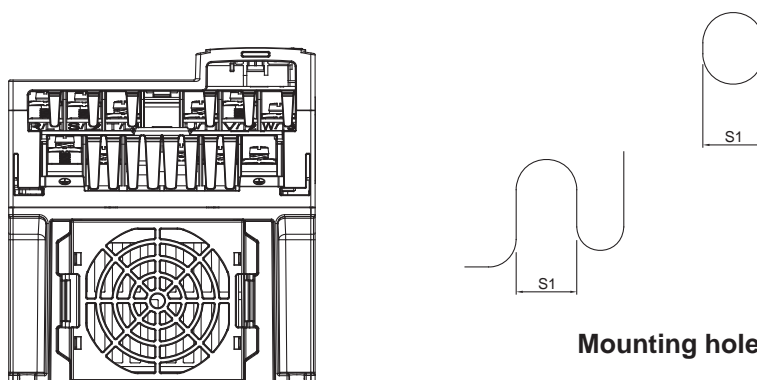
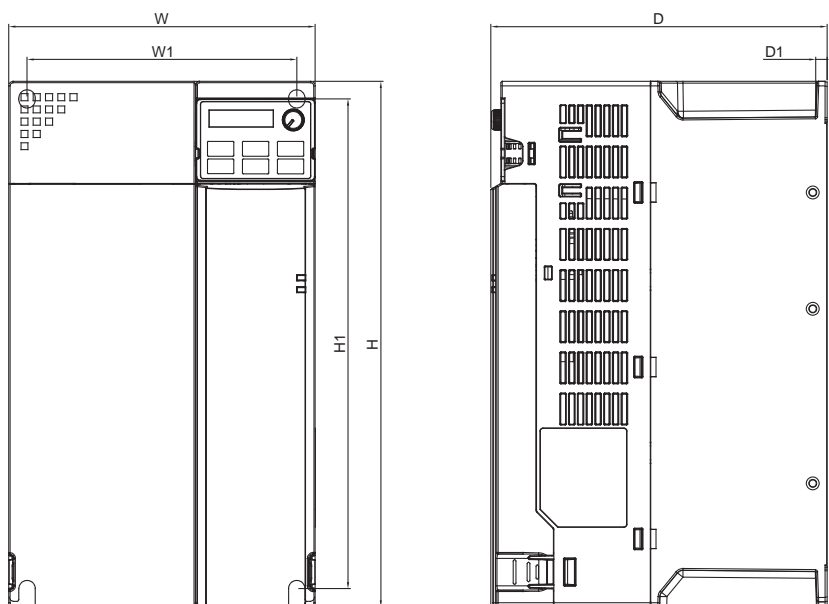

Mounting hole

### MODEL FRAME F1

Standard Models:  
 VFD65AMS23ANSAA  
 VFD65AMS23ENSAA  
 VFD38AMS43ANSAA  
 VFD38AMS43ENSAA  
 VFD45AMS43ANSAA  
 VFD45AMS43ENSAA

High Speed Models:  
 VFD65AMS23ANSHA  
 VFD65AMS23ENSHA  
 VFD38AMS43ANSHA  
 VFD38AMS43ENSHA  
 VFD45AMS43ANSHA  
 VFD45AMS43ENSHA

### FRAME F2

Standard Models:  
 VFD38AMS43AFSAA  
 VFD45AMS43AFSAA

High Speed Models:  
 VFD38AMS43AFSHA  
 VFD45AMS43AFSHA

Frame		W	H	D	W1	H1	D1	S1
F1	mm	175.0	300.0	192.0	154.0	279.5	6.5	8.4
	inch	6.89	11.81	7.56	6.06	11.00	0.26	0.33
Frame		W	H	D	W1	H1	D1	S1
F2	mm	175.0	300.0	244.0	154.0	279.5	6.5	8.4
	inch	6.89	11.81	9.61	6.06	11.00	0.26	0.33

## Accessories

### ▪ CMM-EIP01

EtherNet/IP Option Card



#### Features

- ▶ Supports max. 32 words input and 32 words output of I/O connection
- ▶ User-defined parameter mapping
- ▶ MDI/MDI-X auto-detect
- ▶ IP Filter, basic firewall function
- ▶ E-mail alarm

#### Network Interface

Network protocol	EtherNet/IP	Interface	RJ-45
Transmission speed	10/100Mbps	Number of port	1
Transmission method	I/O connection/Explicit message	Transmission cable	Category 5e shielding
Transmission distance	100m, extension is allowed via switch		

### ▪ CMM-MOD01

MODBUS TCP Option Card



#### Features

- ▶ MDI/MDI-X auto-detect
- ▶ IP Filter, basic firewall function
- ▶ E-mail alarm

#### Network Interface

Network protocol	MODBUS TCP	Interface	RJ-45
Transmission speed	10/100Mbps	Number of port	1
Transmission distance	100m, extension is allowed via switch	Transmission cable	Category 5e shielding

### ▪ CMM-COP01

CANopen Option Card



#### Features

- ▶ Complies with CiA 402 standard (default setting)
- ▶ 4 sets of RX/TX PDO
- ▶ Dual communication ports
- ▶ Node address and Baud rate can be set in the AC motor drive
- ▶ Supports Delta protocol, DMCNET

#### Network Interface

Network protocol	CANopen	Interface	RJ-45
Transmission speed	1M/500k/250k/125k/100k/50kbps	Number of port	2
Transmission method	PDO, SDO	Transmission cable	Delta standard
Transmission distance	25m/1Mbps		

### ▪ CMM-DN01

DeviceNet Option Card



#### Features

- ▶ Support Group 2 only connection method and cyclic I/O data exchange
- ▶ Provides EDS file to identify DeviceNet equipment information
- ▶ Supports max. 32 words input and 32 words output of parameter mapping
- ▶ Node address and Baud rate can be set in the AC motor drive

#### Network Interface

Network protocol	DeviceNet	Interface	Terminal block
Transmission speed	500k/250k/125k/100k/50k bps and extendable baud rate mode of 1M	Number of port	1
Transmission method	Explicit message/Implicit message	Transmission cable	Delta standard
Transmission distance	25m/1Mbps		

## ■ CMM-PD01

PROFIBUS DP Option Card



### Features

- ▶ Supports PZD cyclic data exchange
- ▶ Supports user diagnosis function.
- ▶ Supports PKW read/write to AC motor drive parameters
- ▶ Auto-detects baud rates; supports Max. 12 Mbps.

### Network Interface

Network protocol	PROFIBUS DP	Interface	DB9
Transmission speed	9.6k / 19.2k / 93.75k / 187.5k / 500k / 1.5M / 3M / 6M / 12Mbps	Number of port	1
Transmission method	Cyclic / non-cyclic data exchange	Transmission cable	Delta standard
Transmission distance	100m / 12Mbps		

## ■ Screw Specification of Option Card Terminals

Screw Specification of Option Card Terminals	Wire Gauge	Torque
CMM-COP01	30 ~ 16 AWG (0.0509 ~ 1.31 mm <sup>2</sup> )	2 Kg-cm [1.74 lb-in]
CMM-MOD01 / CMM-EIP01		
CMM-PD01		
CMM-DN01		
EMM-BPS01	30 ~ 16 AWG (0.0509 ~ 1.31 mm <sup>2</sup> )	8 Kg-cm [6.94 lb-in]

## ■ Delta Standard Fieldbus Cables

Delta Cables	Part Number	Description	Length
CANopen Cable	UC-CMC003-01A	CANopen cable, RJ45 connector	0.3m
	UC-CMC005-01A	CANopen cable, RJ45 connector	0.5m
	UC-CMC010-01A	CANopen cable, RJ45 connector	1m
	UC-CMC015-01A	CANopen cable, RJ45 connector	1.5m
	UC-CMC020-01A	CANopen cable, RJ45 connector	2m
	UC-CMC030-01A	CANopen cable, RJ45 connector	3m
	UC-CMC050-01A	CANopen cable, RJ45 connector	5m
	UC-CMC100-01A	CANopen cable, RJ45 connector	10m
	UC-CMC200-01A	CANopen cable, RJ45 connector	20m
DeviceNet Cable	UC-DN01Z-01A	DeviceNet cable	305m
	UC-DN01Z-02A	DeviceNet cable	305m
Ethernet/EtherCAT Cable	UC-EMC003-02A	Ethernet/EtherCAT cable, Shielding	0.3m
	UC-EMC005-02A	Ethernet/EtherCAT cable, Shielding	0.5m
	UC-EMC010-02A	Ethernet/EtherCAT cable, Shielding	1m
	UC-EMC020-02A	Ethernet/EtherCAT cable, Shielding	2m
	UC-EMC050-02A	Ethernet/EtherCAT cable, Shielding	5m
	UC-EMC100-02A	Ethernet/EtherCAT cable, Shielding	10m
	UC-EMC200-02A	Ethernet/EtherCAT cable, Shielding	20m
CANopen/DeviceNet TAP	TAP-CN01	1 in 2 out, built-in 121Ω terminal resistor	1 in 2 out
	TAP-CN02	1 in 4 out, built-in 121Ω terminal resistor	1 in 4 out
	TAP-CN03	1 in 4 out, RJ45 connector, built-in 121Ω terminal resistor	1 in 4 out
PROFIBUS Cable	UC-PF01Z-01A	PROFIBUS DP cable	305m

# Extension Cable for Digital Keypad

## MS300 Extension Cable



Part No.	L	
	mm	[inch]
EG0610C	600	23.6
EG1010C	1000	39.4
EG2010C	2000	78.7
EG3010C	3000	118.1
EG5010C	5000	196.8

## Model Name Explanation

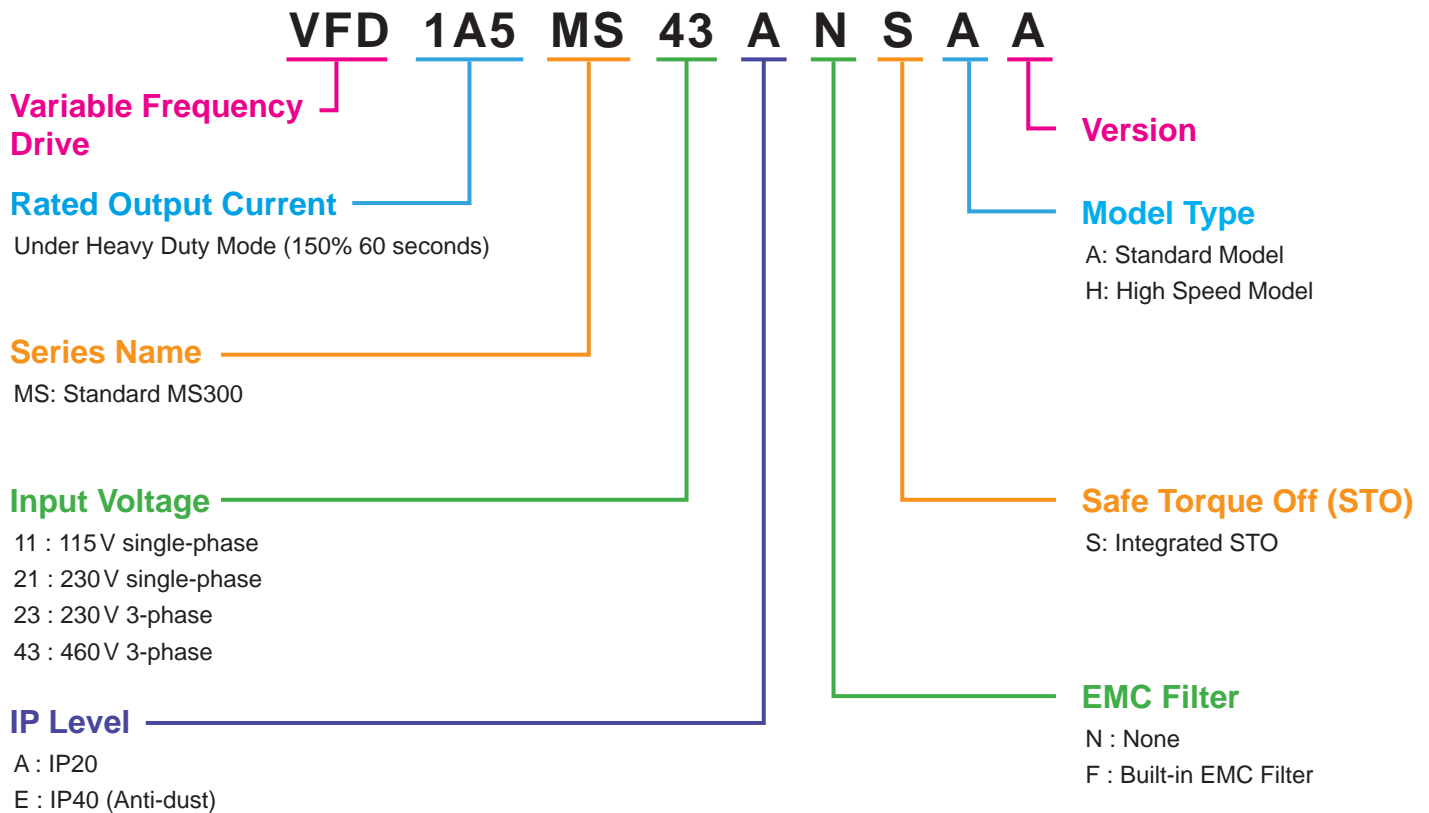

# Ordering Information

## MS300 Standard Models (0 ~ 599 Hz)

Power Range			Frame Size	Model Name	Standard Models (0 ~ 599 Hz)	
Max. Applicable Motor Capacity		Drive Rated Output Current			Built-in EMC Filter	IP40 Models
[HP]	[kW]	[A]				
115V/single-phase						
0.25	0.2	1.6	A	VFD1A6MS11ANSAA	-	-
				VFD1A6MS11ENSAA	-	V
0.5	0.4	2.5	A	VFD2A5MS11ANSAA	-	-
				VFD2A5MS11ENSAA	-	V
1	0.75	4.8	C	VFD4A8MS11ANSAA	-	-
				VFD4A8MS11ENSAA	-	V
230V/single-phase						
1/4	0.2	1.6	A	VFD1A6MS21ANSAA	-	-
			A	VFD1A6MS21ENSAA	-	V
			B	VFD1A6MS21AFSAA	V	-
0.5	0.4	2.8	A	VFD2A8MS21ANSAA	-	-
			A	VFD2A8MS21ENSAA	-	V
			B	VFD2A8MS21AFSAA	V	-
1	0.75	4.8	B	VFD4A8MS21ANSAA	-	-
				VFD4A8MS21AFSAA	V	-
				VFD4A8MS21ENSAA	-	V
2	1.5	7.5	C	VFD7A5MS21ANSAA	-	-
				VFD7A5MS21AFSAA	V	-
				VFD7A5MS21ENSAA	-	V
3	2.2	11.0	C	VFD11AMS21ANSAA	-	-
				VFD11AMS21AFSAA	V	-
				VFD11AMS21ENSAA	-	V
230V/3-phase						
0.25	0.2	1.6	A	VFD1A6MS23ANSAA	-	-
				VFD1A6MS23ENSAA	-	V
0.5	0.4	2.8	A	VFD2A8MS23ANSAA	-	-
				VFD2A8MS23ENSAA	-	V
1	0.75	4.8	A	VFD4A8MS23ANSAA	-	-
				VFD4A8MS23ENSAA	-	V
2	1.5	7.5	B	VFD7A5MS23ANSAA	-	-
				VFD7A5MS23ENSAA	-	V
3	2.2	11.0	C	VFD11AMS23ANSAA	-	-
				VFD11AMS23ENSAA	-	V
5	3.7/4	17.0	C	VFD17AMS23ANSAA	-	-
				VFD17AMS23ENSAA	-	V
7.5	5.5	25.0	D	VFD25AMS23ANSAA	-	-
				VFD25AMS23ENSAA	-	V
10	7.5	33.0	E	VFD33AMS23ANSAA	-	-
				VFD33AMS23ENSAA	-	V
15	11	49.0	E	VFD49AMS23ANSAA	-	-
				VFD49AMS23ENSAA	-	V
20	15	65.0	F	VFD65AMS23ANSAA	-	-
				VFD65AMS23ENSAA	-	V

# Ordering Information

## MS300 Standard Models (0 ~ 599 Hz)

Power Range			Frame Size	Model Name	Standard Models (0 ~ 599 Hz)	
Max. Applicable Motor Capacity		Drive Rated Output Current			Built-in EMC Filter	IP40 Models
[HP]	[kW]	[A]				
460 V/3-phase						
0.5	0.4	1.5	A	VFD1A5MS43ANSAA	-	-
			A	VFD1A5MS43ENSAA	-	V
			B	VFD1A5MS43AFSAA	V	-
1	0.75	2.7	A	VFD2A7MS43ANSAA	-	-
			A	VFD2A7MS43ENSAA	-	V
			B	VFD2A7MS43AFSAA	V	-
2	1.5	4.2	B	VFD4A2MS43ANSAA	-	-
				VFD4A2MS43ENSAA	-	V
				VFD4A2MS43AFSAA	V	-
3	2.2	5.5	C	VFD5A5MS43ANSAA	-	-
				VFD5A5MS43ENSAA	-	V
				VFD5A5MS43AFSAA	V	-
5	3.7/4	9.0	C	VFD9A0MS43ANSAA	-	-
				VFD9A0MS43ENSAA	-	V
				VFD9A0MS43AFSAA	V	-
7.5	5.5	13.0	D	VFD13AMS43ANSAA	-	-
				VFD13AMS43ENSAA	-	V
				VFD13AMS43AFSAA	V	-
10	7.5	17.0	D	VFD17AMS43ANSAA	-	-
				VFD17AMS43ENSAA	-	V
				VFD17AMS43AFSAA	V	-
15	11	25.0	E	VFD25AMS43ANSAA	-	-
				VFD25AMS43ENSAA	-	V
				VFD25AMS43AFSAA	V	-
20	15	32.0	E	VFD32AMS43ANSAA	-	-
				VFD32AMS43ENSAA	-	V
				VFD32AMS43AFSAA	V	-
25	18.5	38.0	F	VFD38AMS43ANSAA	-	-
				VFD38AMS43ENSAA	-	V
				VFD38AMS43AFSAA	V	-
30	22	45.0	F	VFD45AMS43ANSAA	-	-
				VFD45AMS43ENSAA	-	V
				VFD45AMS43AFSAA	V	-

## MS300 High Speed Models (0 ~ 1500 Hz)

Power Range			Frame Size	Model Name	High Speed Models (0 ~ 1500Hz)	
Max. Applicable Motor Capacity		Drive Rated Output Current			Built-in EMC Filter	IP40 Models
[HP]	[kW]	[A]				
230V/single-phase						
2	1.5	7.5	C	VFD7A5MS21ANSHA	-	-
				VFD7A5MS21ENSHA	-	V
				VFD7A5MS21AFSHA	V	-
3	2.2	11.0	C	VFD11AMS21ANSHA	-	-
				VFD11AMS21ENSHA	-	V
				VFD11AMS21AFSHA	V	-
230V/3-phase						
2	1.5	7.5	B	VFD7A5MS23ANSHA	-	-
				VFD7A5MS23ENSHA	-	V
3	2.2	11.0	C	VFD11AMS23ANSHA	-	-
				VFD11AMS23ENSHA	-	V
5	3.7/4	17.0	C	VFD17AMS23ANSHA	-	-
				VFD17AMS23ENSHA	-	V
7.5	5.5	25.0	D	VFD25AMS23ANSHA	-	-
				VFD25AMS23ENSHA	-	V
10	7.5	33.0	E	VFD33AMS23ANSHA	-	-
				VFD33AMS23ENSHA	-	V
15	11	49.0	E	VFD49AMS23ANSHA	-	-
				VFD49AMS23ENSHA	-	V
20	15	65.0	F	VFD65AMS23ANSHA	-	-
				VFD65AMS23ENSHA	-	V
460V/3-phase						
2	1.5	4.2	B	VFD4A2MS43ANSHA	-	-
				VFD4A2MS43ENSHA	-	V
				VFD4A2MS43AFSHA	V	-
3	2.2	5.5	C	VFD5A5MS43ANSHA	-	-
				VFD5A5MS43ENSHA	-	V
				VFD5A5MS43AFSHA	V	-
5	3.7/4	9.0	C	VFD9A0MS43ANSHA	-	-
				VFD9A0MS43ENSHA	-	V
				VFD9A0MS43AFSHA	V	-
7.5	5.5	13.0	D	VFD13AMS43ANSHA	-	-
				VFD13AMS43ENSHA	-	V
				VFD13AMS43AFSHA	V	-
10	7.5	17.0	D	VFD17AMS43ANSHA	-	-
				VFD17AMS43ENSHA	-	V
				VFD17AMS43AFSHA	V	-
15	11	25.0	E	VFD25AMS43ANSHA	-	-
				VFD25AMS43ENSHA	-	V
				VFD25AMS43AFSHA	V	-
20	15	32.0	E	VFD32AMS43ANSHA	-	-
				VFD32AMS43ENSHA	-	V
				VFD32AMS43AFSHA	V	-
25	18.5	38.0	F	VFD38AMS43ANSHA	-	-
				VFD38AMS43ENSHA	-	V
				VFD38AMS43AFSHA	V	-
30	22	45.0	F	VFD45AMS43ANSHA	-	-
				VFD45AMS43ENSHA	-	V
				VFD45AMS43AFSHA	V	-



www.eleris.ru

Smarter. Greener. Together.

## Industrial Automation Headquarters

### **Delta Electronics, Inc.**

Taoyuan Technology Center  
18 Xinglong Road, Taoyuan District,  
Taoyuan City 33068, Taiwan (R.O.C.)  
TEL: 886-3-362-6301 / FAX: 886-3-371-6301

## Asia

### **Delta Electronics (Jiangsu) Ltd.**

Wujiang Plant 3  
1688 Jiangxing East Road,  
Wujiang Economic Development Zone  
Wujiang City, Jiang Su Province, P.R.C. 215200  
TEL: 86-512-6340-3008 / FAX: 86-769-6340-7290

### **Delta Greentech (China) Co., Ltd.**

238 Min-Xia Road, Pudong District,  
ShangHai, P.R.C. 201209  
TEL: 86-21-58635678 / FAX: 86-21-58630003

### **Delta Electronics (Japan), Inc.**

Tokyo Office  
2-1-14 Minato-ku Shibadaimon,  
Tokyo 105-0012, Japan  
TEL: 81-3-5733-1111 / FAX: 81-3-5733-1211

### **Delta Electronics (Korea), Inc.**

1511, Byucksan Digital Valley 6-cha, Gasan-dong,  
Geumcheon-gu, Seoul, Korea, 153-704  
TEL: 82-2-515-5303 / FAX: 82-2-515-5302

### **Delta Electronics Int'l (S) Pte Ltd.**

4 Kaki Bukit Ave 1, #05-05, Singapore 417939  
TEL: 65-6747-5155 / FAX: 65-6744-9228

### **Delta Electronics (India) Pvt. Ltd.**

Plot No 43 Sector 35, HSIIDC  
Gurgaon, PIN 122001, Haryana, India  
TEL : 91-124-4874900 / FAX : 91-124-4874945

## Americas

### **Delta Products Corporation (USA)**

Raleigh Office  
P.O. Box 12173, 5101 Davis Drive,  
Research Triangle Park, NC 27709, U.S.A.  
TEL: 1-919-767-3800 / FAX: 1-919-767-8080

### **Delta Greentech (Brasil) S.A.**

Sao Paulo Office  
Rua Itapeva, 26 - 3° andar Edificio Itapeva One-Bela Vista  
01332-000-São Paulo-SP-Brazil  
TEL: 55 11 3568-3855 / FAX: 55 11 3568-3865

## Europe

### **Delta Electronics (Netherlands) B.V.**

Eindhoven Office  
De Witbogt 20, 5652 AG Eindhoven, The Netherlands  
TEL: +31 (0)40-8003800 / FAX: +31 (0)40-8003898

\*We reserve the right to change the information in this catalogue without prior notice.